

P/N: SA18-11EWA

HIGH EFFICIENCY RED

Features

- 1.8 INCH DIGIT HEIGHT.
- LOW CURRENT OPERATION.
- EXCELLENT CHARACTER APPEARANCE.
- EASY MOUNTING ON P.C. BOARDS OR SOCKETS.
- I.C. COMPATIBLE.
- CATEGORIZED FOR LUMINOUS INTENSITY.
- MECHANICALLY RUGGED.
- STANDARD : GRAY FACE, WHITE SEGMENT.
- RoHS COMPLIANT.

Description

The High Efficiency Red source color devices are made with Gallium Arsenide Phosphide on Gallium Phosphide Orange Light Emitting Diode.

Package Dimensions & Internal Circuit Diagram

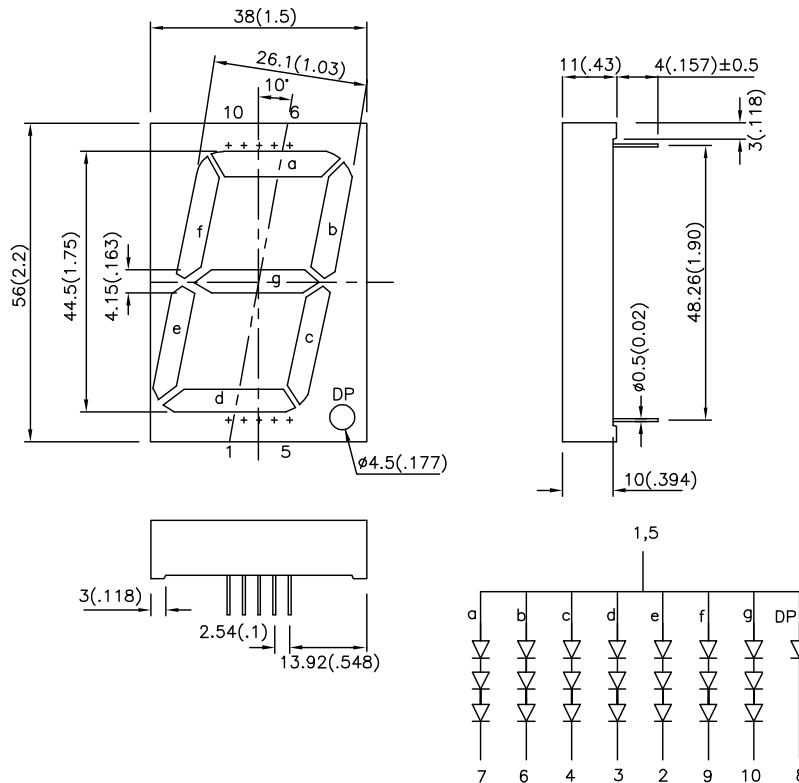

Notes:

1. All dimensions are in millimeters (inches), Tolerance is $\pm 0.25(0.01)$ unless otherwise noted.
2. Specifications are subject to change without notice.

Selection Guide

Part No.	Dice	Lens Type	Iv (ucd) @ 10mA		Description
			Min.	Typ.	
SA18-11EWA	HIGH EFFICIENCY RED (GaAsP/GaP)	WHITE DIFFUSED	4700	24000	Common Anode ,Rt. Hand Decimal.

Electrical / Optical Characteristics at TA=25°C

Symbol	Parameter	Device	Typ.	Max.	Units	Test Conditions
λ_{peak}	Peak Wavelength	High Efficiency Red	627		nm	IF=20mA
λ_D	Dominant Wavelength	High Efficiency Red	625		nm	IF=20mA
$\Delta\lambda_{1/2}$	Spectral Line Half-width	High Efficiency Red	45		nm	IF=20mA
C	Capacitance	High Efficiency Red	15		pF	VF=0V;f=1MHz
VF	Forward Voltage per segment or (Dp)	High Efficiency Red	6.0 (2.0)	7.5 (2.5)	V	IF=20mA
IR	Reverse Current per segment or (Dp)	High Efficiency Red		10	uA	VR = 15V(5V)

Absolute Maximum Ratings at TA=25°C

Parameter	High Efficiency Red	Units
Power dissipation per segment or (Dp)	225(105)	mW
DC Forward Current per segment or (Dp)	30	mA
Peak Forward Current [1] per segment or (Dp)	160(160)	mA
Reverse Voltage per segment or (Dp)	15(5)	V
Operating/Storage Temperature	-40°C To +85°C	
Lead Solder Temperature [2]	260°C For 5 Seconds	

Notes:

- 1/10 Duty Cycle, 0.1ms Pulse Width.
- 2mm below package base.

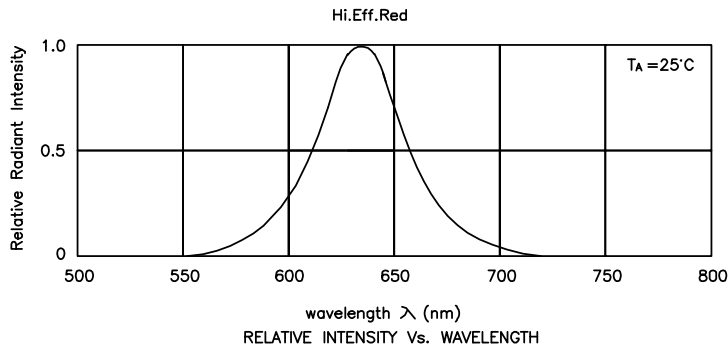

High Efficiency Red

SA18-11EWA

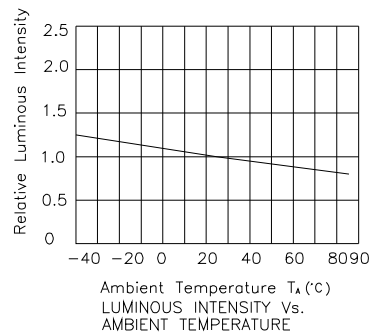
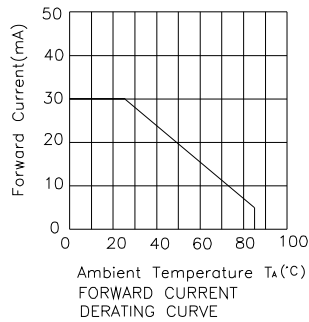
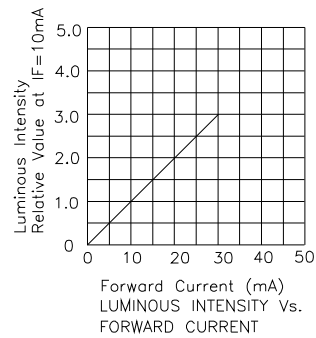
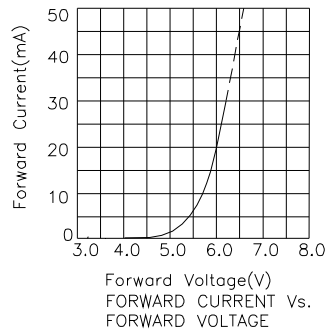

PACKING & LABEL SPECIFICATIONS

SA18-11EWA

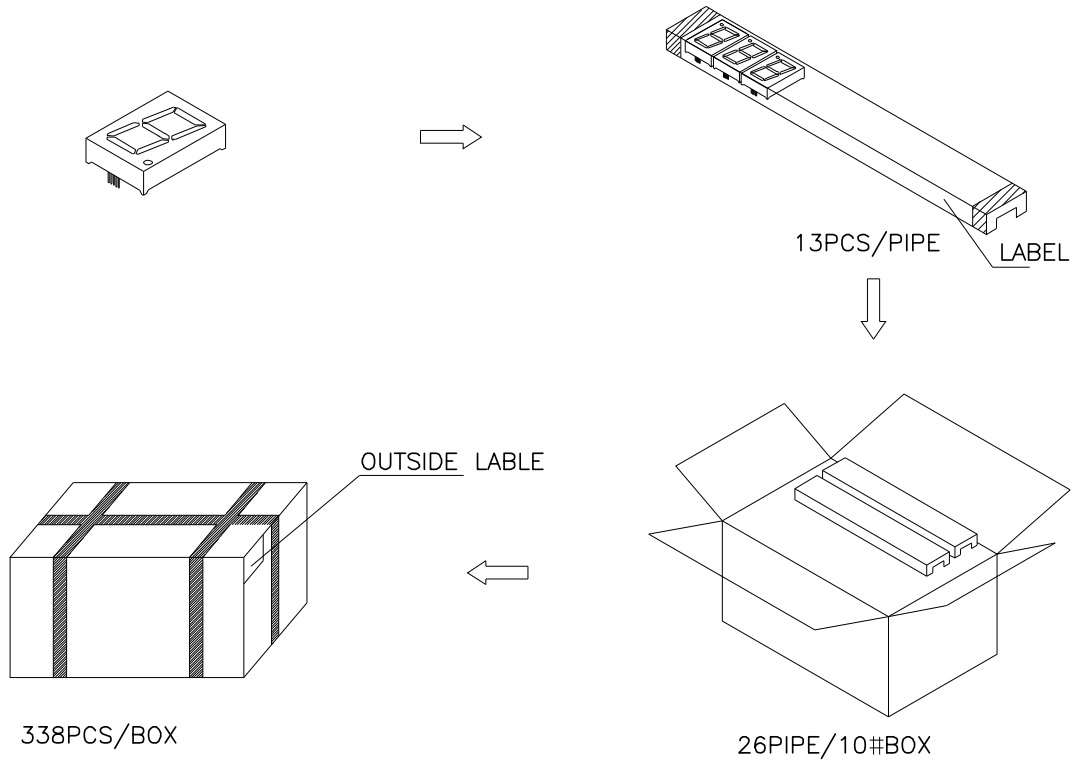

Inside LABEL Paste On The IC-pipe

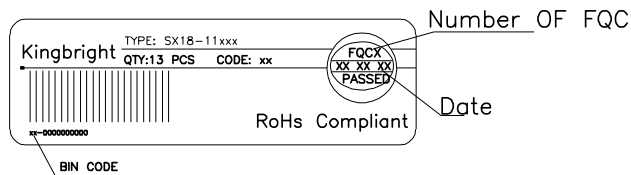

Outside LABEL Paste On The Box

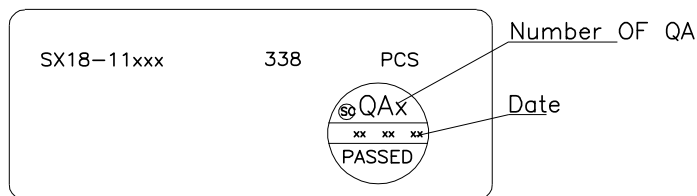

Remarks:

If special sorting is required (e.g. binning based on forward voltage, Luminous intensity/ luminous flux, or wavelength), the typical accuracy of the sorting process is as follows:

1. Wavelength: +/-1nm
2. Luminous intensity/ luminous flux: +/-15%
3. Forward Voltage: +/-0.1V

Note: Accuracy may depend on the sorting parameters.