

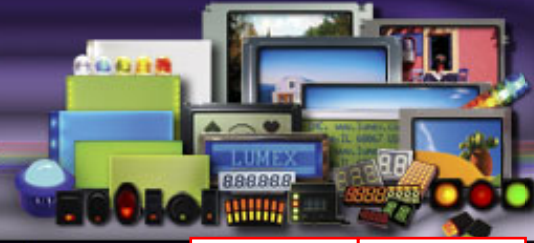

We Tame Photons to Work for You!



Products

Search Tools

Literature

Tech Notes

Search:

For:



Cart Empty

Products > LCD'S > Character Modules > 16 x 2 > 80mm x 36mm

Features / Options

- ▶ Reliable User-interface Display
- ▶ Low Power Consumption
- ▶ Very Long Operational Life
- ▶ Low Cost Power and Signal Interference
- ▶ Customization and Flexibility
- ▶ Affordable Tooling Costs

Applications / Uses

- ▶ Audio Equipment (Home/Office)
- ▶ Consumer Items (Watches, Calculators, Radio, Toys)
- ▶ Automotive Dash Panels
- ▶ Medical Equipment
- ▶ Security Electronics
- ▶ Military Control Panels
- ▶ Testing Equipment

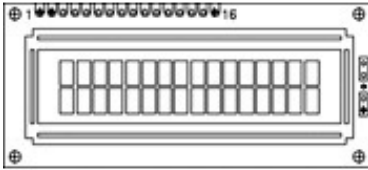

Part Number:		Overall Size (L x W x H)	Viewing Area (W x H)	Character Height (W x H)	Duty		
LCM-S01602DSF/A		80x36x12.7	66x16	2.96x5.56	1/16		
LCM-S01602DSR/A			66x16	2.96x5.56	1/16		
LCM-S01602DTF/A		80x36x12.7	66x16	2.96x5.56	1/16		
LCM-S01602DTR/A			66x16	2.96x5.56	1/16		

UNCONTROLLED DOCUMENT

PART NUMBER		REV.
LCM-X01602DXX/A		A
REV.	E.C.N. NUMBER AND REVISION COMMENTS	DATE
A	E.C.N. #10BRDR. & REDRAWN.	10-2-98

LCM-X	DXX	DESCRIPTION
STANDARD	S	SR STN, REFLECTIVE
	SF	STN, TRANSFLECTIVE(W/ BACKLIGHT)
HIGH TEMP.	H	TR TN, REFLECTIVE
	TF	TN, TRANSFLECTIVE(W/ BACKLIGHT)

CAUTION: STATIC SENSITIVE DEVICE
FOLLOW PROPER E.S.D. HANDLING PROCEDURES
WHEN WORKING WITH THIS PART.

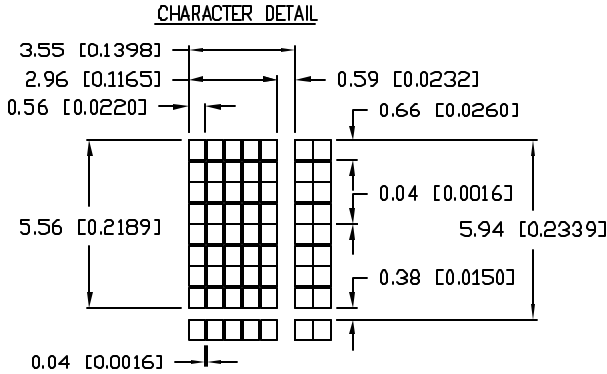

TYPE	DIM.	A	B
WITH BACKLIGHT		12.7	8.7
NO BACKLIGHT		8.8	4.8

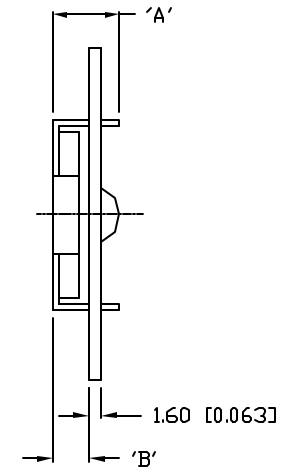
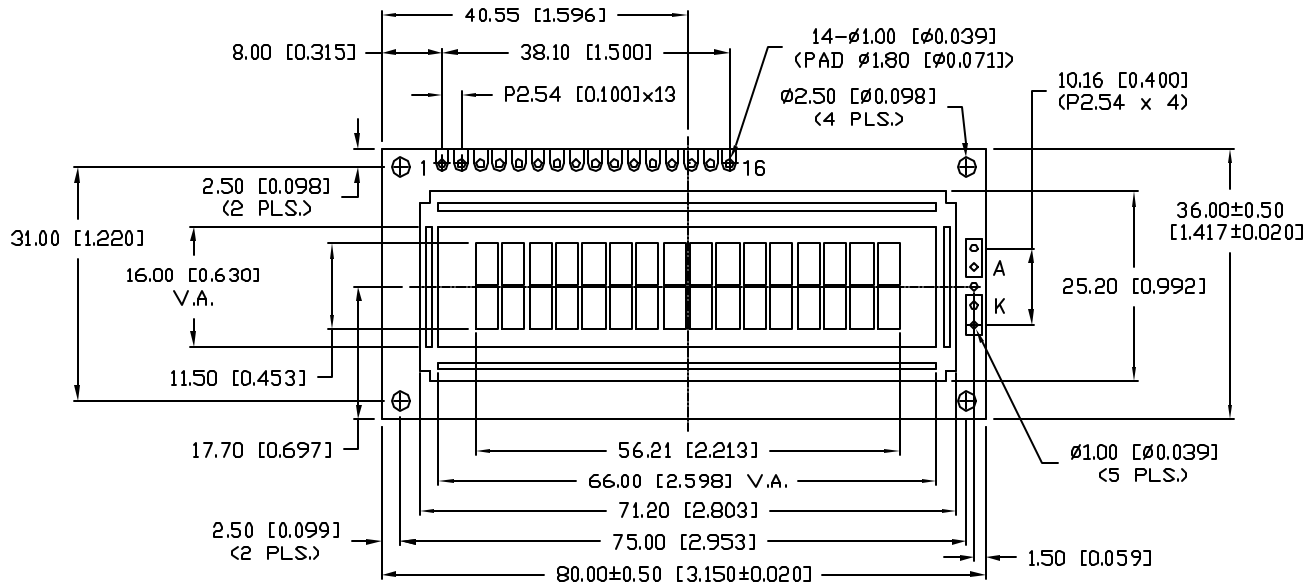

UNCONTROLLED DOCUMENT

*UNLESS OTHERWISE SPECIFIED TOLERANCE IS ±0.25mm (±0.010")

REV. A	PART NUMBER LCM-X01602DXX/A	<p>CONFIDENTIAL INFORMATION</p> <p>THE INFORMATION CONTAINED IN THIS DOCUMENT IS THE PROPERTY OF LUMEX INC. EXCEPT AS SPECIFICALLY AUTHORIZED IN WRITING BY LUMEX INC., THE HOLDER OF THIS DOCUMENT SHALL KEEP ALL INFORMATION CONTAINED HEREIN CONFIDENTIAL AND SHALL PROTECT SAME IN WHOLE OR IN PART FROM DISCLOSURE AND DISSEMINATION TO ALL THIRD PARTIES.</p> <p>RELIABILITY NOTE</p> <p>OUR MANY YEARS OF EXPERIENCE DATA ACCUMULATION INDICATE THAT SOLDER HEAT IS A MAJOR CAUSE OF EARLY AND FUTURE FAILURE. PLEASE PAY ATTENTION TO YOUR SOLDERING PROCESS.</p>	<p>LUMEX INCORPORATED</p> <p>290 E. HELLEN ROAD PALATINE, ILLINOIS 60067 PHONE: 1-847-359-2790 WEB: HTTP://WWW.LUMEX.COM</p>
5.56mm CHARACTER HEIGHT, 5 x 8 DOT MATRIX, 16 x 2 LCD MODULE, 1/16 DUTY, 1/5 BIAS.		<p>DRAWN BY: SA/BC</p>	<p>CHECKED BY:</p> <p>APPROVED BY:</p> <p>DATE: 7-27-98</p> <p>PAGE: 1 OF 2</p> <p>SCALE: N/A</p>

PART NUMBER		REV.
LCM-X01602DXX/A		A
REV.	E.C.N. NUMBER AND REVISION COMMENTS	DATE
	SEE PAGE #1./	

PIN CONFIGURATION			FUNCTION
PIN NO.	SYMBOL	LEVEL	FUNCTION
1	V _{SS}	-	POWER SUPPLY
2	V _{DD}	-	
3	V _O	-	
4	RS	H/L	REGISTER SELECT SIGNAL H: DATA INPUT L: INSTRUCTION INPUT
5	R/W	H/L	H: DATA READ (MODULE-->MPU) L: DATA WRITE (MODULE<<--MPU)
6	E	H,H->L	ENABLE
7~14	DB0~DB7	H/L	DATA BUS-SOFTWARE SELECTABLE 4 OR 8 BIT MODE.
15	A	-	ANODE
16	K	-	CATHODE

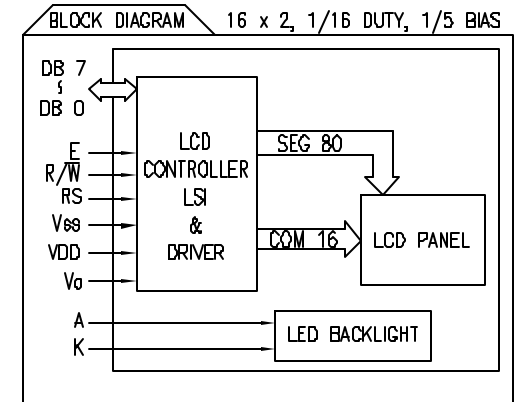
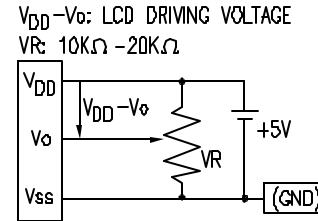

ELECTRICAL CHARACTERISTICS V_{DD}=4.7V to 5.3V, T_A=25°C

ITEM	SYMBOL	CONDITION	STANDARD VALUE			UNIT	
			MIN.	TYP.	MAX.		
SUPPLY VOLTAGE FOR LOGIC	V _{DD} -V _{SS}	-	-	5.0	-	V	
SUPPLY CURRENT FOR LOGIC	I _{DD}	V _{DD} =5V	-	2.0	3.0	mA	
INPUT VOLTAGE	HIGH	V _{IH}	-	2.2	-	V _{DD}	
	LOW	V _{IL}	-	0	-	0.6	
OUTPUT VOLTAGE	HIGH	V _{OH}	-	2.4	-	V	
	LOW	V _{OL}	-	-	0.4	V	
*LED BACKLIGHT	VOLTAGE	V _F	I _F =160mA	-	4.2	4.6	V
	CURRENT	I _F	-	-	160	-	mA
	POWER CONSUMPTION	P _D	-	-	656	-	mW
	LUMINOUS	L	I _F =160mA	70	-	-	cd/m ²
	COLOR	-	-	-	-	-	nm

*ONLY APPLIES TO MODULES WITH BACKLIGHT

ABSOLUTE MAXIMUM RATINGS

ITEM	SYMBOL	TEST CONDITION	STANDARD VALUE		UNIT
SUPPLY VOLTAGE FOR LOGIC	V _{DD} -V _{SS}	T _a =25°C	4.7	5.3	V
SUPPLY VOLTAGE FOR LCD DRIVE	V _{DD} -V _O	-	4.2@50°C	4.8@0°C	V
INPUT VOLTAGE	V _I	T _a =25°C	V _{SS}	V _{DD}	V
OPERATING TEMPERATURE	T _{opr}	LCM-S	0	50	°C
		LCM-H	-20	70	°C
STORAGE TEMPERATURE	T _{stg}	LCM-S	-20	70	°C
		LCM-H	-30	85	°C

*UNLESS OTHERWISE SPECIFIED TOLERANCE IS ±0.25mm (±0.010")

REV. A	PART NUMBER LCM-X01602DXX/A	<p>CONFIDENTIAL INFORMATION</p> <p>THE INFORMATION CONTAINED IN THIS DOCUMENT IS THE PROPERTY OF LUMEX INC. EXCEPT AS SPECIFICALLY AUTHORIZED IN WRITING BY LUMEX INC., THE HOLDER OF THIS DOCUMENT SHALL KEEP ALL INFORMATION CONTAINED HEREIN CONFIDENTIAL AND SHALL PROTECT SAME IN WHOLE OR IN PART FROM DISCLOSURE AND DISSEMINATION TO ALL THIRD PARTIES.</p> <p>RELIABILITY NOTE</p> <p>OUR MANY YEARS OF EXPERIENCE DATA ACCUMULATION INDICATE THAT SOLDER HEAT IS A MAJOR CAUSE OF EARLY AND FUTURE FAILURE. PLEASE PAY ATTENTION TO YOUR SOLDERING PROCESS.</p>	<p>LUMEX INCORPORATED</p> <p>290 E. HELLEN ROAD PALATINE, ILLINOIS 60067 PHONE: 1-847-359-2790 WEB: HTTP://WWW.LUMEX.COM</p>
5.56mm CHARACTER HEIGHT, 5 x 8 DOT MATRIX, 16 x 2 LCD MODULE, 1/16 DUTY, 1/5 BIAS.		<p>DRAWN BY: SA/BC</p> <p>CHECKED BY:</p> <p>APPROVED BY:</p> <p>DATE: 7-27-98</p> <p>PAGE: 2 OF 2</p> <p>SCALE: N/A</p>	