

Part Number: [0008500114](#)
Status: **Active**
Overview: [KK®](#)
Description: [KK® Crimp Terminal, 22-30 AWG, Bag, Hot Tin \(Sn\) Dip, Nickel \(Ni\) Under Plating](#)

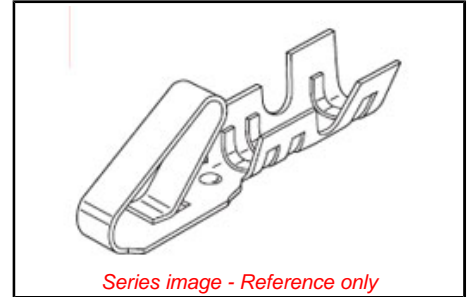

General

Product Family	Crimp Terminals
Series	2759
Overview	KK®
Product Name	KK®

Physical

Gender	Female
Material - Metal	Brass
Material - Plating Mating	Tin
Material - Plating Termination	Tin
Packaging Type	Bag
Plating min: Mating (µm)	100
Plating min: Mating (µm)	2.50
Plating min: Termination (µm)	100
Plating min: Termination (µm)	2.50
Termination Interface: Style	Crimp or Compression
Wire Insulation Diameter	1.57mm (.062") max.
Wire Size AWG	22
Wire Size AWG	24
Wire Size AWG	26
Wire Size AWG	28
Wire Size AWG	30
Wire Size mm²	N/A

Material Info

Old Part Number	2759-(P909)L
-----------------	--------------

EU RoHS
ELV and RoHS
Compliant

China RoHS



20 19 18 17 16 15 14 13 12 11 10 9 8 7 6 5 4 3 2 1

CARRIER VIEW

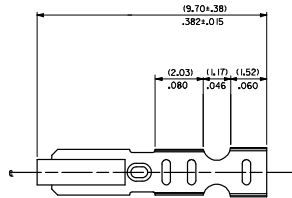
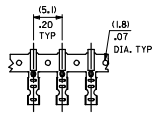

NOTES

1. MATERIAL
10.2030G.0101/0080+.0004 THICK BRASS
2. FINISH
102 - OVERALL TIN: (0.00508)/000200 MIN. TIN OVER
(0.00254)/000100 MIN. COPPER
122 - OVERALL TIN: (0.00381)/000150 MIN. TIN OVER
(0.00076)/000030 MIN. NICKEL
#P909 - OVERALL HOT TIN DP: (0.00254)/000100 MIN.
550 - SELECT GOLD: (0.00038)/000015 MIN.
OVERALL GOLD FLASH: (0.00059)/000002 MIN.
OVERALL NICKEL UNDERPLATE: (0.00076)/000030 MIN.
555 - SELECT GOLD: (0.00038)/000015 MIN.
OVERALL NICKEL UNDERPLATE: (0.00076)/000030 MIN.
558 - SELECT GOLD: (0.00076)/000030 MIN.
OVERALL GOLD FLASH: (0.00059)/000002 MIN.
OVERALL NICKEL UNDERPLATE: (0.00127)/000050 MIN.
*THE PRIMARY SHIPPING CARTON WILL BE LABELED "COMPLIANT TO RoHS
DIRECTIVE 2002/95/EC AND ELV ANNEX I OF DIRECTIVE 2000/53/EC."
CARTONS WITHOUT THIS LABEL MAY CONTAIN PRODUCT WITH TIN-LEAD PLATING.
3. PRODUCT SPEC: PS-0-07
4. PACKAGING SPECIFICATION NONE
5. CRIMP IS FOR 22-30 GA WIRE WITH (157)/.062 DIA INSULATION MAX.
6. INSERTION FORCE OF TERMINAL INTO (2.54)/.100 CENTERLINE CONNECTOR IS 2.5 LBS. MAX
7. TERMINALS WILL RETAIN 8 LBS PULL FOR 1 MIN. IN A (2.54)/.100 CENTERLINE HOUSING.
8. DIMENSIONS GIVEN ACROSS CENTERLINES ARE SYMMETRICAL ABOUT THOSE CENTERLINES WITHIN HALF THE TOTAL TOLERANCE.
9. CODE LETTER PRECEDING PART NO. DESIGNATES MANUFACTURING LOCATION: IRELAND
10. THIS PART CONFORMS TO CLASS B REQUIREMENTS OF COSMETIC SPECIFICATION PS-45499-002.

SELECT GOLD LOCATION

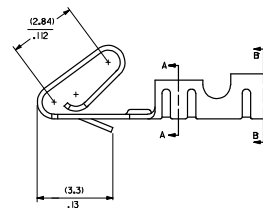
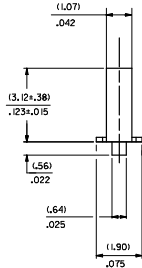
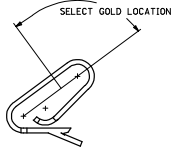

CRIMP DETAIL

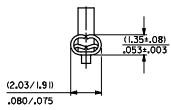

CRIMPED TERMINAL 2759-IP90 ILC IS USED WITHOUT WIRE AND IS INSERTED INTO HEADERS DURING SHIPMENT.

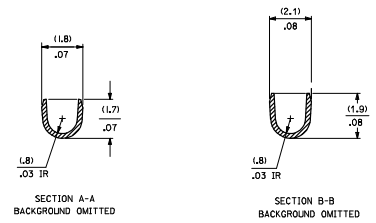
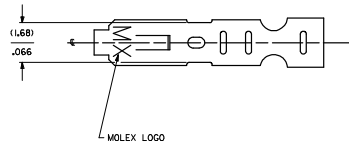

2759-(****) *
FORM
L=LOOSE
C=LOOSE CRIMPED
A=CHAIN PER ES-339-A
B=CHAIN PER ES-339-B
PLATING
SEE NOTE 2

QUALITY SYMBOLS ▽=0 ▽=0	GENERAL TOLERANCES (UNLESS SPECIFIED) DIM INCH 4 PLACES ± .010 3 PLACES ± .012 2 PLACES ± .014 1 PLACE ± 0.36 ± .012* ANGULAR ± 1/2°		DIMENSION STYLE MM/IN DRAWN BY: SAMIEC DATE: 07/28/87 CHECKED BY: PATEL DATE: 07/28/87 APPROVED BY: LENZ DATE: 07/28/87		SCALE: --- DESIGN UNITS: INCH THIRD ANGLE PROJECTION
	DRAFT WHERE APPLICABLE MUST REMAIN WITHIN DIMENSIONS		MATERIAL NO. SEE CHART DOCUMENT NO. SD-2759		MOLEX INCORPORATED SHEET NO. 1 OF 2

19 18 17 16 15 14 13 12 11 10 9 8 7 6 5 4 3 2 1

2.54mm (.100") Pitch KK[®] Crimp Terminal

2759/6459

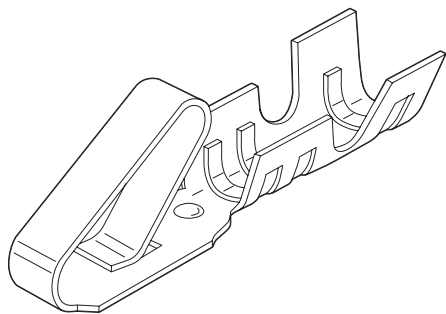

Features and Benefits

- Standard cantilever terminal
- Cantilever design provides high contact pressure
- Wiping action cleans oxides when connector is mated
- 2759 Series is Brass
- 6459 Series is Phosphor Bronze

Reference Information

Product Specification: PS-10-07
 Packaging: Reel or bag
 Tooling Information: See crimp tooling section
 UL File No.: E29179
 CSA File No.: LR19980
 Use With: 2695, 5051 and 6745 housings
 Designed In: Inches

Electrical

Voltage: 250V
 Current: 6459—4.0A
 2759—2.5A
 Contact Resistance: 20 milliohms max.
 Dielectric Withstanding Voltage: 1500V
 Insulation Resistance: 50K Megohms min.

Mechanical

Wire Pull-Out Force:

Wire Gauge (AWG)	22	24	26	28	30
Pull-Out Force (lb)	10	8	6	4	3

Mating Force: 255g max.
 Unmating Force: 50g min.
 Normal Force: 200g min.

Physical

Contact: 6459—Phosphor Bronze; 2759—Brass
 Plating: See Table
 Wire Accommodation: 22 to 30 AWG
 Insulation Range: 1.58mm (.062") diameter max.

Contact	Order No.						Wire Gauge (AWG)	Insulation OD	Lead-free
	Tin Plating		15µ" Gold Plating		15µ" Selective Gold Plating				
	Reel	Bag	Reel	Bag	Reel	Bag			
Brass	08-50-0113	08-50-0114	08-56-0109	08-56-0110	08-55-0101	08-55-0102	22-30	1.57 (.062)	Yes
Phosphor Bronze	08-52-0101	08-52-0123	08-65-0813	08-65-0814	08-65-0815	08-65-0816			

2.54mm (.100") Pitch KK[®] Cat Ear Terminal

5159

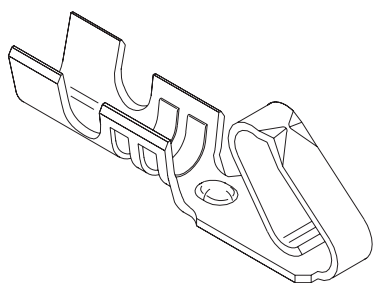

Features and Benefits

- Similar to 2759/6459 Series with cat ears
- Cat ears provide 2 high pressure points of contact
- Suitable for high vibrational requirements

Reference Information

Product Specification: PS-10-07
 Packaging: Bag or reel
 Tooling Information: See crimp tooling section
 UL File No.: E29179
 CSA File No.: LR19980
 Use With: 2695, 5051 and 6471
 Designed In: Inches

Electrical

Voltage: 250V
 Current: 3.0A
 Contact Resistance: 20 milliohms max.
 Dielectric Withstanding Voltage: 1000V AC
 Insulation Resistance: 1000 Megohms min.

Physical

Contact: Phosphor Bronze and Brass
 Plating: Tin
 Wire Accommodation: 22 to 30 AWG

Order No.				Lead-free
Phosphor Bronze		Brass		
Bag	Reel	Bag	Reel	
08-70-0049	08-70-0048	08-70-0069	08-70-0064	Yes

Preferred version in the Far East