

CIRCUIT SIZE	DIM. 'A'	DIM. 'B'	DIM. 'C'
2	.21 (5.4)	—	.370 (9.40)
4	.38 (9.6)	.17 (4.2)	.535 (13.60)
6	.54 (13.8)	.33 (8.4)	.701 (17.80)
8	.71 (18.0)	.50 (12.6)	.866 (22.00)
10	.87 (22.2)	.66 (16.8)	1.031 (26.20)
12	1.04 (26.4)	.83 (21.0)	1.197 (30.40)
14	1.20 (30.6)	.99 (25.2)	1.362 (34.60)
16	1.37 (34.8)	1.16 (29.4)	1.528 (38.80)
18	1.54 (39.0)	1.32 (33.6)	1.693 (43.00)
20	1.70 (43.2)	1.49 (37.8)	1.858 (47.20)
22	1.87 (47.4)	1.65 (42.0)	2.024 (51.40)
24	2.03 (51.6)	1.82 (46.2)	2.189 (55.60)

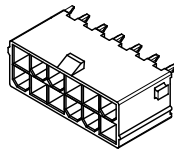

12 CKT SHOWN

- NOTES:
- MATERIALS:  
HOUSING MATERIAL AND OPTIONS: SEE CHART  
TERMINALS: BRASS
  - TERMINAL PLATING:  
A = .000035/(0.00089) MIN. BRIGHT TIN OVER  
.000020/(0.00051) MIN. COPPER OVERALL  
B = .000030/(0.00076) MIN. SELECT GOLD AND  
.000100/(0.00254) MIN. MATTE TIN OVER  
.000050/(0.00127) MIN. NICKEL OVERALL  
C = .000100/(0.00254) MIN. BRIGHT TIN OVER  
.000050/(0.00127) MIN. NICKEL OVERALL
  - PRODUCT SPECIFICATION: PS-5556-001
  - PACKAGING: SEE CHART.
  - PART MATES WITH MINI-FIT JR. RECEPTACLE #5557.
  - PARTS ARE NOT DESIGNED FOR CURRENT SHARING.
  - CONNECTOR ASSEMBLIES ARE NOT DESIGNED TO BE MATED OR UNMATED WHILE CIRCUITS ARE LIVE.
  - LOCATION OF .118±.002/(3.00±0.05) DIAMETER HOLES ON P.C. BOARD IS FOR OPTIONAL PEGS.
  - PART CONFORMS TO CLASS 'B' REQUIREMENTS OF COSMETIC SPECIFICATION PS-45499-002 EXCEPT IN AREA OF PEG CUT-OFF.

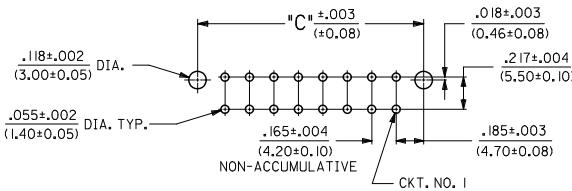
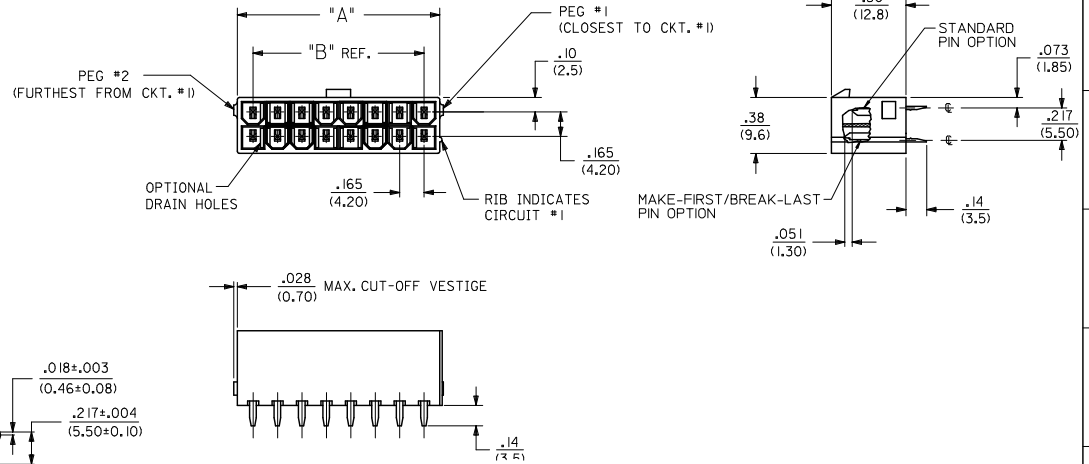

RECOMMENDED HOLE LAYOUT FOR .070/(1.78) MAX. THICK P.C. BOARD VIEWED FROM COMPONENT SIDE (SEE NOTE 8)

SEE SHEET 2 FOR SINGLE ROW PRODUCT

ADD -0024 EC NO. UCP2011-3352 DRAWN: JAGUILAR 2011/04/28 CHKD: BELL 2011/04/28 APPR: SMITH 2011/05/02	QUALITY SYMBOLS ▽=0 ▽=0 ▽=0	GENERAL TOLERANCES (UNLESS SPECIFIED)	DIMENSION STYLE IN/MM	SCALE 2:1	DESIGN UNITS METRIC	THIRD ANGLE PROJECTION			
		4 PLACES ±.010 ±.010 3 PLACES ±.010 ±.010 2 PLACES ±.025 ±.014 1 PLACE ±.036 ±.010 ANGULAR ±1/2°	DRAWN BY AFG	DATE 1995/07/19	TITLE 2-24 CKT VERT HDR ASSY W/PEGS REMOVED OPTION W/WO DRAIN HOLE MINI-FIT	APPROVED BY FSM/TH	DATE 2010/03/08	MATERIAL NO. SDA-43588-****	DOCUMENT NO. MOLEX INCORPORATED
DRAFT WHERE APPLICABLE MUST REMAIN WITHIN DIMENSIONS		SEE SHEET 3	THIS DRAWING CONTAINS INFORMATION THAT IS PROPRIETARY TO MOLEX INCORPORATED AND SHOULD NOT BE USED WITHOUT WRITTEN PERMISSION						

CKT SIZE	DIM A	DIM B
4	.709 (18.00)	.496 (12.60)
5	.874 (22.20)	.661 (16.80)
6	1.039 (26.40)	.827 (21.00)
7	1.205 (30.60)	.992 (25.20)
8	1.370 (34.80)	1.157 (29.40)
9	1.535 (39.00)	1.323 (33.60)
10	1.701 (43.20)	1.488 (37.80)
11	1.866 (47.40)	1.654 (42.00)
12	2.031 (51.60)	1.819 (46.20)

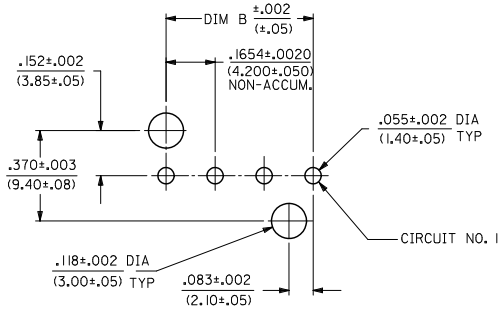
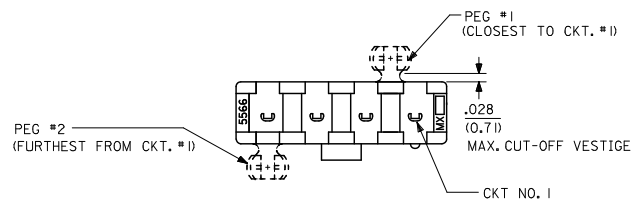
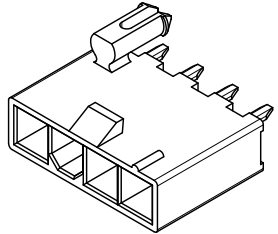

RECOMMENDED HOLE LAYOUT FOR  
.070/(1.78) MAX. THICK P. C. BOARD  
VIEWED FROM THICK SIDE  
(SEE NOTE B)

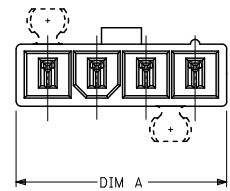
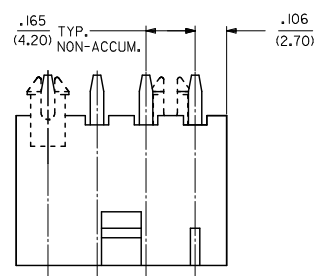
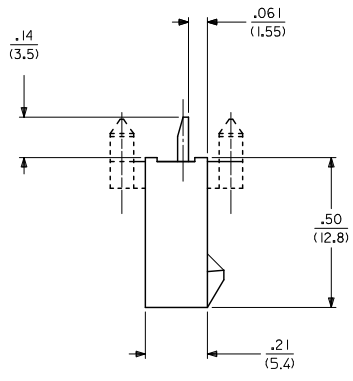

SEE SHEET 1 FOR DUAL ROW PRODUCT

SEE SHEET 1 EC. NO. UCP2011-3352 DRAWN: JAGUILAR 2011/04/28 CHKD: BELL 2011/04/28 APPR: SMITH 2011/05/02	QUALITY SYMBOLS 	GENERAL TOLERANCES (UNLESS SPECIFIED)		DIMENSION STYLE	SCALE	DESIGN UNITS	THIRD ANGLE PROJECTION		
		mm	INCH	IN/MM	2:1	METRIC			
		DRAWN BY DATE		CHECKED BY DATE		TITLE			
		APPROVED BY DATE		MATERIAL NO.		DOCUMENT NO.		SHEET NO.	
DRAFT WHERE APPLICABLE MUST REMAIN WITHIN DIMENSIONS		SEE SHEET 3		2-24 CKT VERT HDR ASSY W/PEGS REMOVED OPTION W/WO DRAIN HOLE MINI-FIT				2 OF 4	
REV		SIZE		THIS DRAWING CONTAINS INFORMATION THAT IS PROPRIETARY TO MOLEX INCORPORATED AND SHOULD NOT BE USED WITHOUT WRITTEN PERMISSION					



