

CIRCUIT SIZE	DIM. "A"	DIM. "B"	DIM. "C"
2	.21 (5.4)	—	.370 (9.40)
4	.38 (9.6)	.17 (4.2)	.535 (13.60)
6	.54 (13.8)	.33 (8.4)	.701 (17.80)
8	.71 (18.0)	.50 (12.6)	.866 (22.00)
10	.87 (22.2)	.66 (16.8)	1.031 (26.20)
12	1.04 (26.4)	.83 (21.0)	1.197 (30.40)
14	1.20 (30.6)	.99 (25.2)	1.362 (34.60)
16	1.37 (34.8)	1.16 (29.4)	1.528 (38.80)
18	1.54 (39.0)	1.32 (33.6)	1.693 (43.00)
20	1.70 (43.2)	1.49 (37.8)	1.858 (47.20)
22	1.87 (47.4)	1.65 (42.0)	2.024 (51.40)
24	2.03 (51.6)	1.82 (46.2)	2.189 (55.60)

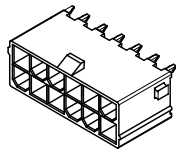

12 CKT SHOWN

- NOTES:
- MATERIALS:
HOUSING MATERIAL AND OPTIONS: SEE CHART
TERMINALS: BRASS
 - TERMINAL PLATING:
A = .000035/(0.00089) MIN. BRIGHT TIN OVER
.000020/(0.00051) MIN. COPPER OVERALL
B = .000030/(0.00076) MIN. SELECT GOLD AND
.000100/(0.00254) MIN. MATTE TIN OVER
.000050/(0.00127) MIN. NICKEL OVERALL
C = .000100/(0.00254) MIN. BRIGHT TIN OVER
.000050/(0.00127) MIN. NICKEL OVERALL
 - PRODUCT SPECIFICATION: PS-5556-001
 - PACKAGING: SEE CHART.
 - PART MATES WITH MINI-FIT JR. RECEPTACLE #5557.
 - PARTS ARE NOT DESIGNED FOR CURRENT SHARING.
 - CONNECTOR ASSEMBLIES ARE NOT DESIGNED TO BE MATED OR UNMATED WHILE CIRCUITS ARE LIVE.
 - LOCATION OF .118±.002/(3.00±0.05) DIAMETER HOLES ON P.C. BOARD IS FOR OPTIONAL PEGS.
 - PART CONFORMS TO CLASS "B" REQUIREMENTS OF COSMETIC SPECIFICATION PS-45499-002 EXCEPT IN AREA OF PEG CUT-OFF.

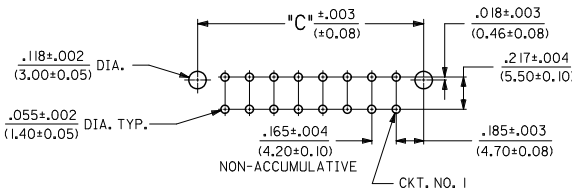
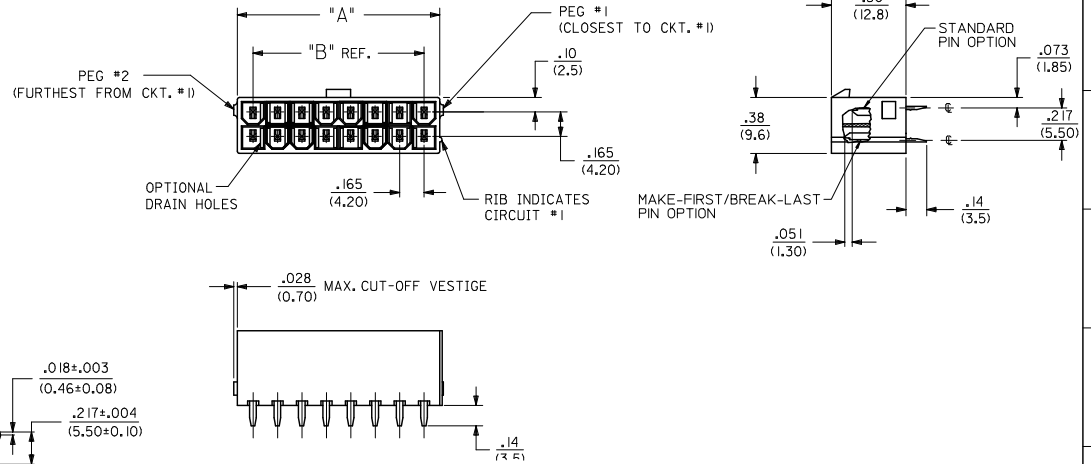

RECOMMENDED HOLE LAYOUT FOR .070/(1.78) MAX. THICK P.C. BOARD VIEWED FROM COMPONENT SIDE (SEE NOTE 8)

SEE SHEET 2 FOR SINGLE ROW PRODUCT

ADD -0024 EC NO. UCP2011-3352 DRAWN: JAGUILAR 2011/04/28 CHKD: JEBELL 2011/04/28 APPR: F SMITH 2011/05/02	QUALITY SYMBOLS ▽=0 ▽=0 ▽=0	GENERAL TOLERANCES (UNLESS SPECIFIED)	DIMENSION STYLE IN/MM	SCALE 2:1	DESIGN UNITS METRIC	THIRD ANGLE PROJECTION
		4 PLACES ±.010 ±.010 3 PLACES ±.010 ±.010 2 PLACES ±.025 ±.014 1 PLACE ±.036 ±.010 ANGULAR ±1/2°	DRAWN BY AFG	DATE 1995/07/19	TITLE 2-24 CKT VERT HDR ASSY W/PEGS REMOVED OPTION W/WO DRAIN HOLE MINI-FIT	MOLEX INCORPORATED
DRAFT WHERE APPLICABLE MUST REMAIN WITHIN DIMENSIONS	SEE SHEET 3	MATERIAL NO.	DOCUMENT NO.	SHEET NO.	1 OF 4	
THIS DRAWING CONTAINS INFORMATION THAT IS PROPRIETARY TO MOLEX INCORPORATED AND SHOULD NOT BE USED WITHOUT WRITTEN PERMISSION						

CKT SIZE	DIM A	DIM B
4	.709 (18.00)	.496 (12.60)
5	.874 (22.20)	.661 (16.80)
6	1.039 (26.40)	.827 (21.00)
7	1.205 (30.60)	.992 (25.20)
8	1.370 (34.80)	1.157 (29.40)
9	1.535 (39.00)	1.323 (33.60)
10	1.701 (43.20)	1.488 (37.80)
11	1.866 (47.40)	1.654 (42.00)
12	2.031 (51.60)	1.819 (46.20)

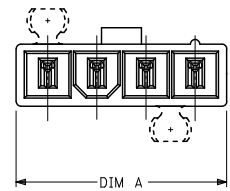
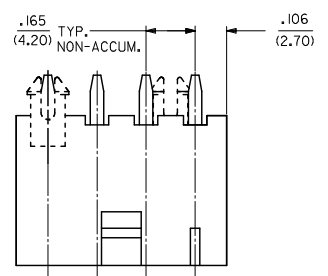
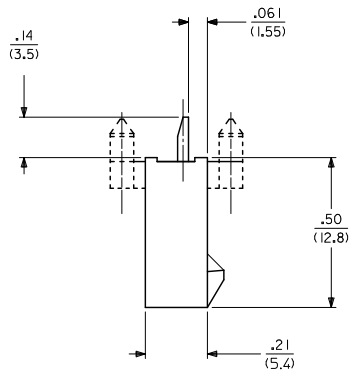
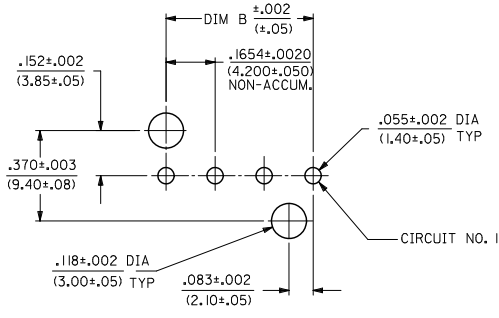
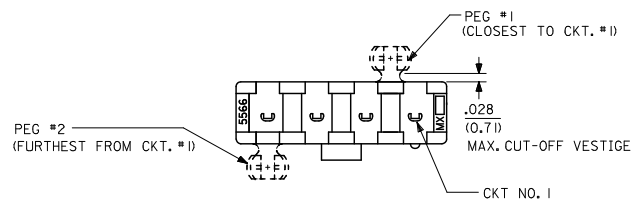
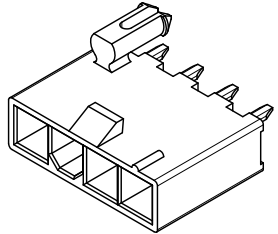

SEE SHEET 1 FOR DUAL ROW PRODUCT

SEE SHEET 1 EC. NO. UEP2011-3352 DRAWN: JAGUILAR 2011/04/28 CHKD: BELL 2011/04/28 APPR: SMITH 2011/05/02	QUALITY SYMBOLS 	GENERAL TOLERANCES (UNLESS SPECIFIED)		DIMENSION STYLE	SCALE	DESIGN UNITS	THIRD ANGLE PROJECTION	
				IN/MM	2:1	METRIC		
				mm	INCH			
				4 PLACES ±.010 ±.010	3 PLACES ±.010 ±.010	2 PLACES ±.025 ±.014	1 PLACE ±.036 ±.014	ANGULAR ±1/2°
DRAFT WHERE APPLICABLE MUST REMAIN WITHIN DIMENSIONS		MATERIAL NO.		DATE		TITLE		
D13		SEE SHEET 3		2010/03/08		2-24 CKT VERT HDR ASSY W/PEGS REMOVED OPTION W/WO DRAIN HOLE MINI-FIT		
		MATERIAL NO.		DATE		MOLEX INCORPORATED		
		SDA-43588-****		2010/03/08		MOLEX INCORPORATED		
		DOCUMENT NO.		DATE		SHEET NO.		
		2 OF 4		2010/03/08		2 OF 4		
THIS DRAWING CONTAINS INFORMATION THAT IS PROPRIETARY TO MOLEX INCORPORATED AND SHOULD NOT BE USED WITHOUT WRITTEN PERMISSION								

