

PRODUCT NUMBER
SEE TABLE

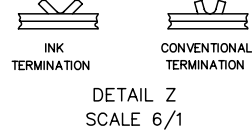
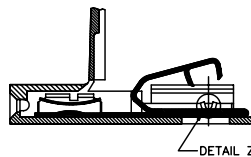
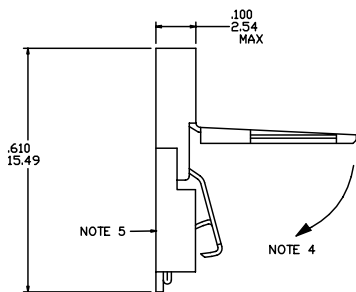
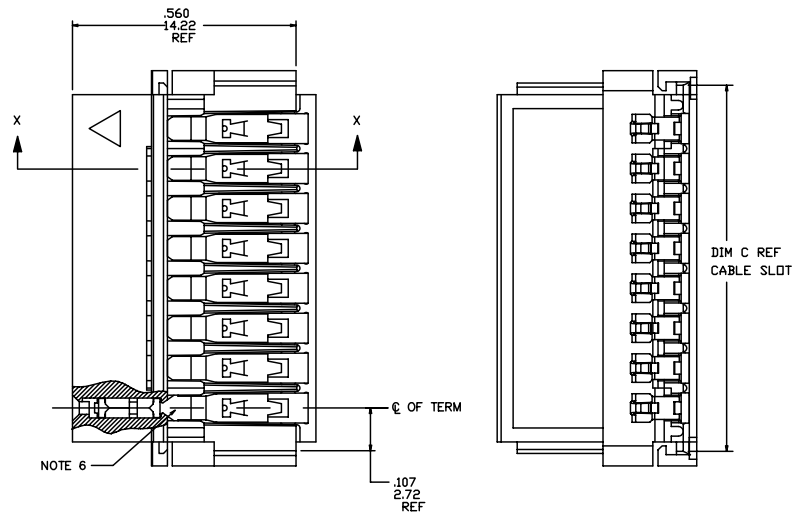
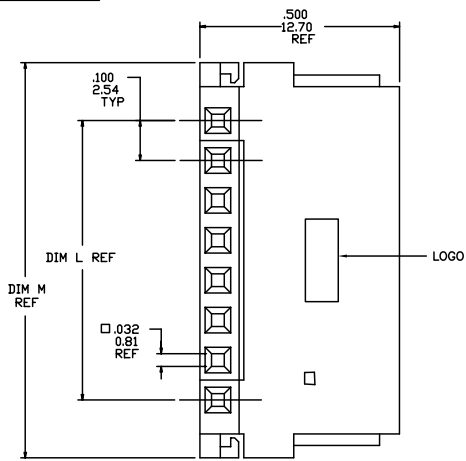

mat'l code		surface	tolerance	projection	product family
		ISO 1902	ISO 406 ISO 1101	ISO 10	CLINCHER
lir	ecm no	dr	date	title	
AF	V50167	HTB	1/19/95	CLINCHER™ RECEPTACLE ASSEMBLY	
AG	V50220	HTB	2/7/95	scale 3:1	
AH	V60509	HTB	3/5/96	sheet 1 of 7 size	
AJ	M05-0087	MHT	6/15/05	65801 A3	
AK	M06-0233	AGS	6/12/06	type Product Customer Drawing	
AL	M07-0088	MHT	2/06/07		
AM	M09-0062	CMR	4/09/09		
sheet	revision	AM	AM	AM	AM
index	sheet	1	2	3	4

PLATING AVAILABLE			
PLATING CODE	TERMINAL	SPRING	
1	100u"/2.54u MIN. THICK PURE TIN	10u"/.25u MIN. THICK PURE TIN	
2	30u"/.76u MIN. GOLD STRIPE IN BOX AREA	3u"/.08u MIN. GOLD OVER 50u"/1.27u MIN. NICKLE	

PRODUCT NUMBER
65801-XXXLF

LEAD FREE OPTION
NOTE 9,10

NO OF POSITIONS
AND PLATING

BASE PART NUMBER

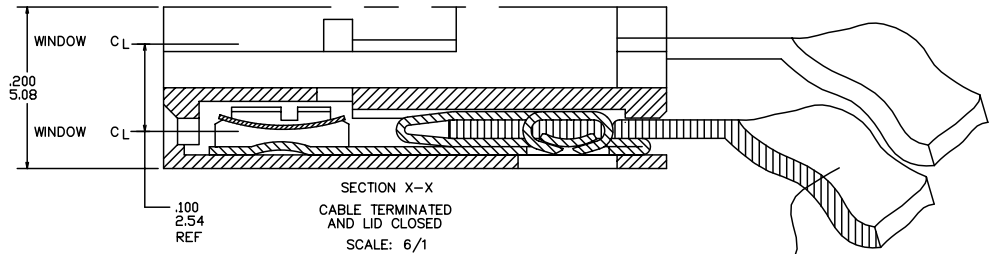

NOTES:

- ① MOLDING MAT'L: POLYPROPYLENE, FLAME RETARDENT PER UL 94V-0. COLOR: BLUE.
- ② TERMINAL MAT'L: 1/2 HARD CuNi ALLOY, UNS-C72500. PLATING: SEE TABULATION AND PLATING TABLE.
- ③ SPRING MAT'L: 1/2 HARD BeCu ALLOY, UNS-C17200. PLATING: SEE TABULATION AND PLATING TABLE.
- ④ LATCH SWINGS CLOSED AFTER TERMINATION MAINTAINING A MAX OVER ALL HEIGHT OF .100/2.54
- ⑤ LABEL IN THIS AREA P/N AND DATE LOT CODE (WEEK AND YEAR) ON DASH No.-067 AND -167 ONLY.
- ⑥ KNURL MARK INDICATES FOR USE WITH INK TERMINATION. CONSULT WITH BERG ELECTRONICS TECHNICAL REPRESENTATIVE FOR SPECIFIC APPLICATIONS.
- ⑦ POSITION NUMBERS INITIATE FROM TRIANGULAR MARK ON HOUSING. SEE TABULATION FOR POSITION No CLOSED AND TERMINAL No ABSENT. FIG A SHOWS POSITION No 2 CLOSED.
- ⑧ AN EIGHT DIGIT PART NUMBER FOLLOWED BY A "J" INDICATES INVENTORY FOR JAPAN ONLY.
- ⑨ ADD "LF" SUFFIX AT THE END OF PART NUMBER FOR LEAD FREE OPTION.
- ⑩ THIS PRODUCT MEETS EUROPEAN UNION DIRECTIVES AND OTHER COUNTRY REGULATION AS DESCRIBED IN GS-22-008.
- ⑪ THE PRODUCT IS NOT INTENDED TO BE EXPOSED TO A MANUFACTURING SOLDER PROCESS

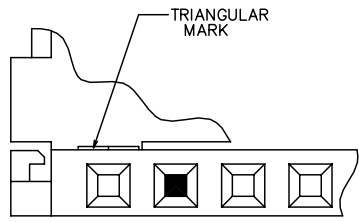

FIG A
NOTE 7

mat'l code	surface	tolerance	projection	product family
itr	ISO 1902	ISO 406	ASME	CLINCHER
ecm no	date	ISO 1101	INCH/MM	title
AM		tolerances unless otherwise specified	scale 3:1	CLINCHER™ RECEPTACLE ASSEMBLY
	angles	linear		dwg no
	0°±2°	.XX±.01/.3		65801
		.XXX±.005/.13		sheet 2 of 7
	dr	.000±.0020/.051		size
	engr			A3
	chr			type
	appd			Product Customer Drawing
sheet index	revision sheet			

PRODUCT NO. NOTE 9	NO. OF POSITIONS	DIM. L		DIM. M		DIM. C		PLATING CODE	TERMINATION NOTE 6	NOTES	
		ENGLISH	METRIC	ENGLISH	METRIC	ENGLISH	METRIC				
65801-001		U N A S S I G N E D									
65801-002	2	0.100	2.54	0.390	9.91	0.315	8.00	1	CONVENTIONAL	-	
65801-003	3	0.200	5.08	0.490	12.45	0.415	10.54	1	CONVENTIONAL	-	
65801-004	4	0.300	7.62	0.590	14.99	0.515	13.08	1	CONVENTIONAL	-	
65801-005	5	0.400	10.16	0.690	17.53	0.615	15.62	1	CONVENTIONAL	-	
65801-006	6	0.500	12.70	0.790	20.07	0.715	18.16	1	CONVENTIONAL	-	
65801-007	7	0.600	15.24	0.890	22.61	0.815	20.70	1	CONVENTIONAL	-	
65801-008	8	0.700	17.78	0.990	25.15	0.915	23.24	1	CONVENTIONAL	-	
65801-009	9	0.800	20.32	1.090	27.69	1.015	25.78	1	CONVENTIONAL	-	
65801-010	10	0.900	22.86	1.190	30.23	1.115	28.32	1	CONVENTIONAL	-	
65801-011	11	1.000	25.40	1.290	32.77	1.215	30.86	1	CONVENTIONAL	-	
65801-012	12	1.100	27.94	1.390	35.31	1.315	33.40	1	CONVENTIONAL	-	
65801-013	13	1.200	30.48	1.490	37.85	1.415	35.94	1	CONVENTIONAL	-	
65801-014	14	1.300	33.02	1.590	40.39	1.515	38.48	1	CONVENTIONAL	-	
65801-015	15	1.400	35.56	1.690	42.93	1.615	41.02	1	CONVENTIONAL	-	
65801-016	16	1.500	38.10	1.790	45.47	1.715	43.56	1	CONVENTIONAL	-	
65801-017	17	1.600	40.64	1.890	48.01	1.815	46.10	1	CONVENTIONAL	NOTE 8	
65801-018	18	1.700	43.18	1.990	50.55	1.915	48.64	1	CONVENTIONAL	-	
65801-019	19	1.800	45.72	2.090	53.09	2.015	51.18	1	CONVENTIONAL	-	
65801-020	20	1.900	48.26	2.190	55.63	2.115	53.72	1	CONVENTIONAL	-	
65801-021	21	2.000	50.80	2.290	58.17	2.215	56.26	1	CONVENTIONAL	-	
65801-022	22	2.100	53.34	2.390	60.71	2.315	58.80	1	CONVENTIONAL	-	
65801-023	23	2.200	55.88	2.490	63.25	2.415	61.34	1	CONVENTIONAL	-	
65801-024	24	2.300	58.42	2.590	65.79	2.515	63.88	1	CONVENTIONAL	-	
65801-025	25	2.400	60.96	2.690	68.33	2.615	66.42	1	CONVENTIONAL	-	
65801-026	26	2.500	63.50	2.790	70.87	2.715	68.96	1	CONVENTIONAL	-	
65801-027	27	2.600	66.04	2.890	73.41	2.815	71.50	1	CONVENTIONAL	-	
65801-028	28	2.700	68.58	2.990	75.95	2.915	74.04	1	CONVENTIONAL	-	
65801-029	29	2.800	71.12	3.090	78.49	3.015	76.58	1	CONVENTIONAL	-	
65801-030	30	2.900	73.66	3.190	81.03	3.115	79.12	1	CONVENTIONAL	-	
65801-031	31	3.000	76.20	3.290	83.57	3.215	81.66	1	CONVENTIONAL	-	
65801-032	32	3.100	78.74	3.390	86.11	3.315	84.20	1	CONVENTIONAL	-	

mat'l code		surface	tolerance	projection	product family
itr	ecrn no	ISO 1902	ISO 406	1st angle	CLINCHER
AM	dr	ISO 1101	ISO 1101	INCH/MM	CLINCHER™ RECEPTACLE ASSEMBLY
	date	tolerances unless otherwise specified		scale	3:1
		angles	linear		
		0°±2'	.XX±.01/.3		
			.XXX±.005/.13		
			.XXX±.0020/.051		
		dr	T.BREWBAKER	5/17/94	
		eng	T. HANNA	5/17/94	
		chr	J.MURPHY	5/17/94	
		appd	T. HANNA	5/17/94	
sheet	revision				
index	sheet				

PDM: Rev:AM STATUS: Released Printed: Jul 22, 2010

FCJ
FCJconnect.com
Copyright FCJ

PRODUCT NO. NOTE 9	NO. OF POSITIONS	DIM. L		DIM. M		DIM. C		PLATING CODE	TERMINATION NOTE 6	NOTES
		ENGLISH	METRIC	ENGLISH	METRIC	ENGLISH	METRIC			
65801-033	4	0.300	7.62	0.590	14.99	0.515	13.08	2	CONVENTIONAL	-
65801-034	5	0.400	10.16	0.690	17.53	0.615	15.62	2	CONVENTIONAL	-
65801-035	6	0.500	12.70	0.790	20.07	0.715	18.16	2	CONVENTIONAL	-
65801-036	7	0.600	15.24	0.890	22.61	0.815	20.70	2	CONVENTIONAL	-
65801-037	8	0.700	17.78	0.990	25.15	0.915	23.24	2	CONVENTIONAL	-
65801-038	9	0.800	20.32	1.090	27.69	1.015	25.78	2	CONVENTIONAL	-
65801-039	10	0.900	22.86	1.190	30.23	1.115	28.32	2	CONVENTIONAL	-
65801-040	11	1.000	25.40	1.290	32.77	1.215	30.86	2	CONVENTIONAL	-
65801-041	12	1.100	27.94	1.390	35.31	1.315	33.40	2	CONVENTIONAL	-
65801-042	13	1.200	30.48	1.490	37.85	1.415	35.94	2	CONVENTIONAL	-
65801-043	14	1.300	33.02	1.590	40.39	1.515	38.48	2	CONVENTIONAL	-
65801-044	15	1.400	35.56	1.690	42.93	1.615	41.02	2	CONVENTIONAL	-
65801-045	16	1.500	38.10	1.790	45.47	1.715	43.56	2	CONVENTIONAL	-
65801-046	17	1.600	40.64	1.890	48.01	1.815	46.10	2	CONVENTIONAL	-
65801-047	18	1.700	43.18	1.990	50.55	1.915	48.64	2	CONVENTIONAL	-
65801-048	19	1.800	45.72	2.090	53.09	2.015	51.18	2	CONVENTIONAL	-
65801-049	20	1.900	48.26	2.190	55.63	2.115	53.72	2	CONVENTIONAL	-
65801-050	21	2.000	50.80	2.290	58.17	2.215	56.26	2	CONVENTIONAL	-
65801-051	22	2.100	53.34	2.390	60.71	2.315	58.80	2	CONVENTIONAL	-
65801-052	23	2.200	55.88	2.490	63.25	2.415	61.34	2	CONVENTIONAL	-
65801-053	24	2.300	58.42	2.590	65.79	2.515	63.88	2	CONVENTIONAL	-
65801-054	25	2.400	60.96	2.690	68.33	2.615	66.42	2	CONVENTIONAL	-
65801-055	26	2.500	63.50	2.790	70.87	2.715	68.96	2	CONVENTIONAL	-
65801-056	27	2.600	66.04	2.890	73.41	2.815	71.50	2	CONVENTIONAL	-
65801-057	28	2.700	68.58	2.990	75.95	2.915	74.04	2	CONVENTIONAL	-
65801-058	29	2.800	71.12	3.090	78.49	3.015	76.58	2	CONVENTIONAL	-
65801-059	30	2.900	73.66	3.190	81.03	3.115	79.12	2	CONVENTIONAL	-
65801-060	31	3.000	76.20	3.290	83.57	3.215	81.66	2	CONVENTIONAL	-
65801-061	32	3.100	78.74	3.390	86.11	3.315	84.20	2	CONVENTIONAL	-
65801-062	3	0.200	5.08	0.490	12.45	0.415	10.54	2	CONVENTIONAL	-
65801-063	2	0.100	2.54	0.390	9.91	0.315	8.00	2	CONVENTIONAL	-
65801-064	34	3.300	83.82	3.590	91.19	3.515	89.28	1	CONVENTIONAL	-
65801-065	33	3.200	81.28	3.490	88.65	3.415	86.74	1	CONVENTIONAL	-
65801-066	34	3.300	83.82	3.590	91.19	3.515	89.28	2	CONVENTIONAL	-
65801-067	12	1.100	27.94	1.390	35.31	1.315	33.40	2	CONVENTIONAL	NOTE 5

mat'l code	surface ISO 1902	tolerance ISO 406 ISO 1101	projection	product family CLINCHER
itr	ecrn no	dr	date	title CLINCHER™ RECEPTACLE ASSEMBLY
AM				dwg no 65801
	angles	linear	scale 3:1	sheet 4 of 7 size A3
	0°±2'			type Product Customer Drawing
	dr	T.BREWBAKER	5/17/94	
	engr	T. HANNA	5/17/94	
	chr	J. MURPHY	5/17/94	
	appd	T. HANNA	5/17/94	
sheet index	revision sheet			

PRODUCT NO. NOTE 9	NO. OF POSITIONS	DIM. L		DIM. M		DIM. C		PLATING CODE	TERMINATION NOTE 6	NOTES
		ENGLISH	METRIC	ENGLISH	METRIC	ENGLISH	METRIC			
65801-102	2	0.100	2.54	0.390	9.91	0.315	8.00	1	INK	-
65801-103	3	0.200	5.08	0.490	12.45	0.415	10.54	1	INK	-
65801-104	4	0.300	7.62	0.590	14.99	0.515	13.08	1	INK	-
65801-105	5	0.400	10.16	0.690	17.53	0.615	15.62	1	INK	-
65801-106	6	0.500	12.70	0.790	20.07	0.715	18.16	1	INK	-
65801-107	7	0.600	15.24	0.890	22.61	0.815	20.70	1	INK	-
65801-108	8	0.700	17.78	0.990	25.15	0.915	23.24	1	INK	-
65801-109	9	0.800	20.32	1.090	27.69	1.015	25.78	1	INK	-
65801-110	10	0.900	22.86	1.190	30.23	1.115	28.32	1	INK	-
65801-111	11	1.000	25.40	1.290	32.77	1.215	30.86	1	INK	-
65801-112	12	1.100	27.94	1.390	35.31	1.315	33.40	1	INK	-
65801-113	13	1.200	30.48	1.490	37.85	1.415	35.94	1	INK	-
65801-114	14	1.300	33.02	1.590	40.39	1.515	38.48	1	INK	-
65801-115	15	1.400	35.56	1.690	42.93	1.615	41.02	1	INK	-
65801-116	16	1.500	38.10	1.790	45.47	1.715	43.56	1	INK	-
65801-117	17	1.600	40.64	1.890	48.01	1.815	46.10	1	INK	-
65801-118	18	1.700	43.18	1.990	50.55	1.915	48.64	1	INK	-
65801-119	19	1.800	45.72	2.090	53.09	2.015	51.18	1	INK	-
65801-120	20	1.900	48.26	2.190	55.63	2.115	53.72	1	INK	-
65801-121	21	2.000	50.80	2.290	58.17	2.215	56.26	1	INK	-
65801-122	22	2.100	53.34	2.390	60.71	2.315	58.80	1	INK	-
65801-123	23	2.200	55.88	2.490	63.25	2.415	61.34	1	INK	-
65801-124	24	2.300	58.42	2.590	65.79	2.515	63.88	1	INK	-
65801-125	25	2.400	60.96	2.690	68.33	2.615	66.42	1	INK	-
65801-126	26	2.500	63.50	2.790	70.87	2.715	68.96	1	INK	-
65801-127	27	2.600	66.04	2.890	73.41	2.815	71.50	1	INK	-
65801-128	28	2.700	68.58	2.990	75.95	2.915	74.04	1	INK	-
65801-129	29	2.800	71.12	3.090	78.49	3.015	76.58	1	INK	-
65801-130	30	2.900	73.66	3.190	81.03	3.115	79.12	1	INK	-
65801-131	31	3.000	76.20	3.290	83.57	3.215	81.66	1	INK	-
65801-132	32	3.100	78.74	3.390	86.11	3.315	84.20	1	INK	-



Copyright FCI

mat'l code	surface ISO 1902	tolerance ISO 406 ISO 1101	projection	product family CLINCHER
itr	ecm no	dr	date	tolerances unless otherwise specified
AM				angles linear .XX±.01/.3 .XXX±.005/.13 XXXX±.0020/.051
				0"±2"
				dr T.BREWBAKER 5/17/94
				engr T. HANNA 5/17/94
				chr J.MURPHY 5/17/94
				appd T. HANNA 5/17/94
sheet index	revision sheet			scale 3:1
				INCH/MM
				FCI
				title CLINCHER™ RECEPTACLE ASSEMBLY
				dwg no 65801 sheet 5 of 7 size A3
				type Product Customer Drawing

PRODUCT NO. NOTE 9	NO. OF POSITIONS	DIM. L		DIM. M		DIM. C		PLATING CODE	TERMINATION NOTE 6	NOTES	
		ENGLISH	METRIC	ENGLISH	METRIC	ENGLISH	METRIC				
65801-133	4	0.300	7.62	0.590	14.99	0.515	13.08	2	INK	-	
65801-134	5	0.400	10.16	0.690	17.53	0.615	15.62	2	INK	-	
65801-135	6	0.500	12.70	0.790	20.07	0.715	18.16	2	INK	-	
65801-136	7	0.600	15.24	0.890	22.61	0.815	20.70	2	INK	-	
65801-137	8	0.700	17.78	0.990	25.15	0.915	23.24	2	INK	-	
65801-138	9	0.800	20.32	1.090	27.69	1.015	25.78	2	INK	-	
65801-139	10	0.900	22.86	1.190	30.23	1.115	28.32	2	INK	-	
65801-140	11	1.000	25.40	1.290	32.77	1.215	30.86	2	INK	-	
65801-141	12	1.100	27.94	1.390	35.31	1.315	33.40	2	INK	-	
65801-142	13	1.200	30.48	1.490	37.85	1.415	35.94	2	INK	-	
65801-143	14	1.300	33.02	1.590	40.39	1.515	38.48	2	INK	-	
65801-144	15	1.400	35.56	1.690	42.93	1.615	41.02	2	INK	-	
65801-145	16	1.500	38.10	1.790	45.47	1.715	43.56	2	INK	-	
65801-146	17	1.600	40.64	1.890	48.01	1.815	46.10	2	INK	-	
65801-147	18	1.700	43.18	1.990	50.55	1.915	48.64	2	INK	-	
65801-148	19	1.800	45.72	2.090	53.09	2.015	51.18	2	INK	-	
65801-149	20	1.900	48.26	2.190	55.63	2.115	53.72	2	INK	-	
65801-150	21	2.000	50.80	2.290	58.17	2.215	56.26	2	INK	-	
65801-151	22	2.100	53.34	2.390	60.71	2.315	58.80	2	INK	-	
65801-152	23	2.200	55.88	2.490	63.25	2.415	61.34	2	INK	-	
65801-153	24	2.300	58.42	2.590	65.79	2.515	63.88	2	INK	-	
65801-154	25	2.400	60.96	2.690	68.33	2.615	66.42	2	INK	-	
65801-155	26	2.500	63.50	2.790	70.87	2.715	68.96	2	INK	-	
65801-156	27	2.600	66.04	2.890	73.41	2.815	71.50	2	INK	-	
65801-157	28	2.700	68.58	2.990	75.95	2.915	74.04	2	INK	-	
65801-158	29	2.800	71.12	3.090	78.49	3.015	76.58	2	INK	-	
65801-159	30	2.900	73.66	3.190	81.03	3.115	79.12	2	INK	-	
65801-160	31	3.000	76.20	3.290	83.57	3.215	81.66	2	INK	-	
65801-161	32	3.100	78.74	3.390	86.11	3.315	84.20	2	INK	-	
65801-162	3	0.200	5.08	0.490	12.45	0.415	10.54	2	INK	-	
65801-163	2	0.100	2.54	0.390	9.91	0.315	8.00	2	INK	-	
65801-164				UNASSIGNED							
65801-165				UNASSIGNED							
65801-166	34	3.300	83.82	3.590	91.19	3.515	89.28	2	INK	-	
65801-167	12	1.100	27.94	1.390	35.31	1.315	33.40	2	INK	NOTE 5	

mat'l code	surface ISO 1802	tolerance ISO 406 ISO 1101	projection	product family CLINCHER
itr	ecm no	dr	date	title CLINCHER™ RECEPTACLE ASSEMBLY
AM				dwg no 65801
				sheet 6 of 7 size A3
				type Product Customer Drawing
sheet index	revision sheet			

PDM: Rev:AM STATUS:Released Printed: Jul 22, 2010

PRODUCT NO. NOTE 9	NO. OF POSITIONS	1		2 3				4		5		6
		DIM. L ENGLISH	DIM. L METRIC	DIM. M ENGLISH	DIM. M METRIC	DIM. C ENGLISH	DIM. C METRIC	PLATING CODE	TERMINATION NOTE 6	CLOSED POS. NOTE 7	TERMINAL ABSENT NOTE 7	
65801-201	16	1.500	38.10	1.790	45.47	1.715	43.56	1	CONVENTIONAL	4	4.5.6	
65801-202	5	0.400	10.16	0.690	17.53	0.615	15.62	2	CONVENTIONAL	3	3	
65801-203	7	0.600	15.24	0.890	22.61	0.815	20.70	2	CONVENTIONAL	6	1.2.6.7	
65801-204	10	0.900	22.86	1.190	30.23	1.115	28.32	1	CONVENTIONAL	4	4	
65801-205	6	0.500	12.70	0.790	20.07	0.715	18.16	1	CONVENTIONAL	5	5	
65801-206	5	0.400	10.16	0.690	17.53	0.615	15.62	1	CONVENTIONAL	4	4	
65801-207	7	0.600	15.24	0.890	22.61	0.815	20.70	2	CONVENTIONAL	N/A	1.2.6.7	
65801-208	4	0.300	7.62	0.590	14.99	0.515	13.08	1	CONVENTIONAL	N/A	2.3	
65801-209	3	0.200	5.08	0.490	12.45	0.415	10.54	1	CONVENTIONAL	N/A	2	



Copyright FCI

mat'l code	surface ISO 1902	tolerance ISO 406 ISO 1101	projection	product family CLINCHER
itr	ecm no	dr	date	title CLINCHER™ RECEPTACLE ASSEMBLY
AM				dwg no 65801
	angles	linear	scale 3:1	sheet 7 of 7 size A3
	0°±2"			type Product Customer Drawing
	dr	T.BREWBAKER	5/17/94	
	engr	T. HANNA	5/17/94	
	chr	J.MURPHY	5/17/94	
	appd	T. HANNA	5/17/94	
sheet index	revision sheet			

PDM: Rev:AM STATUS:Released Printed: Jul 22, 2010