



Deutsche Version

- Home
- About Us
- Products
- Support
- News
- Sitemap

Search

Products only

© Neutrik® AG
 All rights reserved
 Legal Notices



Phono (RCA) Sockets

Audio back

Print



NF2D-0

Phono socket in nickel D-shape housing, black isolation washers, solder version.

ACCESSORIES

DSS-*	MFD	SCDX

A-A

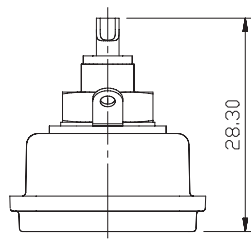
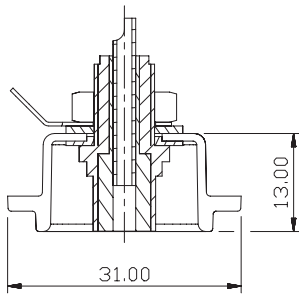

Frontplattenausschnitt (Rückseite)
Panel cut out (rear side)

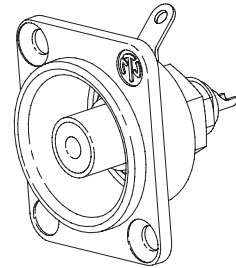
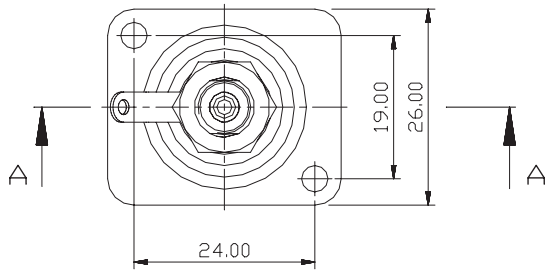
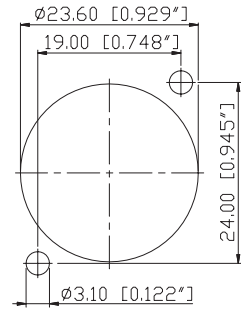

				Werkstoff	Massstab		Datum	Name	
				*Lieferant darf ohne Ruecksprache nicht geändert werden Zeichnung urheberrechtlich geschützt (TM 34) (C)	1:1		Gezeichnet	10.12.02	Botlg
						Gepuift			
						Gesehen			
				Benennung: Phono Sockets		Ersetzt durch		Blatt	
				NF2D		Ersatz fuer		von Blatt	
A	Panel cut out	20.10.03	NB	NEUTRIK AG FL-9494 SCHAAN		Zeichn. Nr.			
Ind.	Aenderung	Datum	Name						



Audio

Phono (RCA) Sockets

NF2D-0

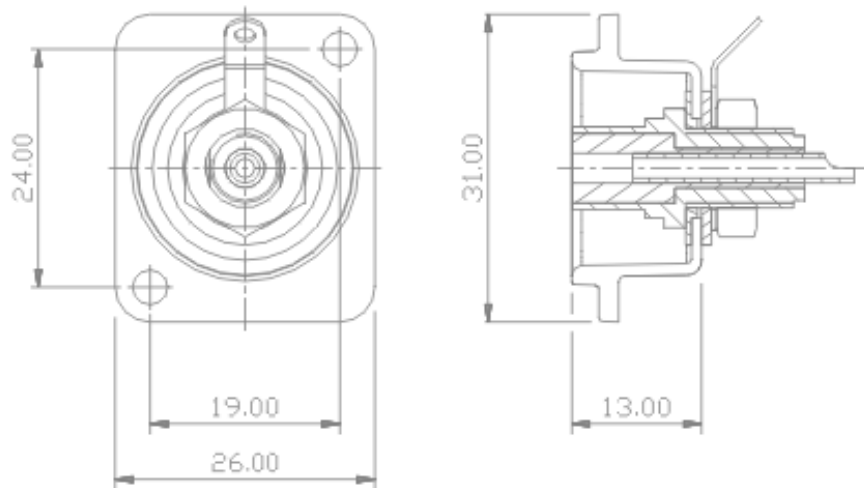

There are no technical infos for this product.

Product

Connector Type	RCA
Gender	female

Electrical

Capacitance between contacts	≤ 9 pF
------------------------------	-------------

Mechanical

Wiring	Solder contacts
Mounting direction	front
Chassis shape	D

Material

Environmental

Standard compliance	IEC 601-14
Solderability	Complies with IEC 68-2-20

Optical

Mobile Cables