

PRODUCT NUMBER
SEE TABLE

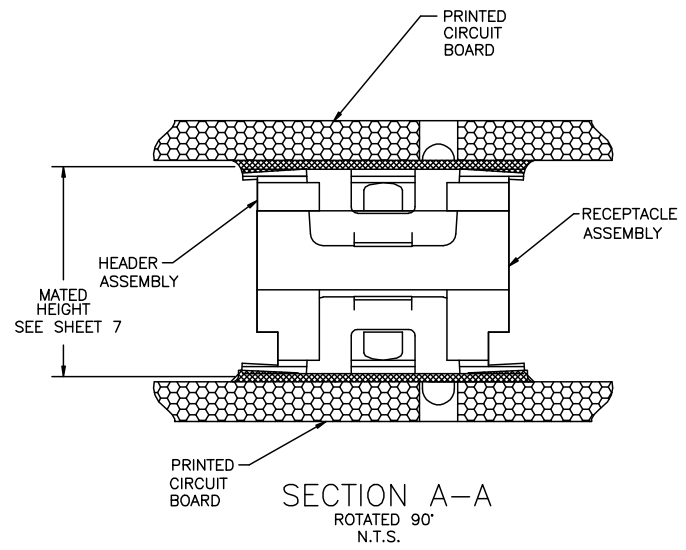

mal'l. code		surface	tolerance	projection	product family
		ISO 1902	ISO 1436 ISO 1101		CONAN
itr		tolerances unless otherwise specified		title	
ecn no	dr	date	angles	linear	INCH/MM
Y V03-1347	AA	12/20/01	XXL01/XXL03		CONAN™ CONNECTOR ASSEMBLY
AA M04-0190	MHT	9/24/04	XXXL005/XXXL013	scale 5:1	dwg no 91900 sheet 1 of 7 size A3
AB M05-0110	MHT	5/26/05	0'±2'		type Product Customer Drawing
AC M06-0232	AGS	06/12/08	dr	R.SEIPLE	11/13/91
AD M06-0373	MHT	9/26/06	engr	D.HORCHLER	01/10/92
AE M08-0012	AGS	1/11/08	chr	D.HORCHLER	01/10/92
AF M08-0287	MHT	10/02/08	appd	D.HORCHLER	01/10/92
sheet	revision	AF	AF	AF	AF
index	sheet	1	2	3	4

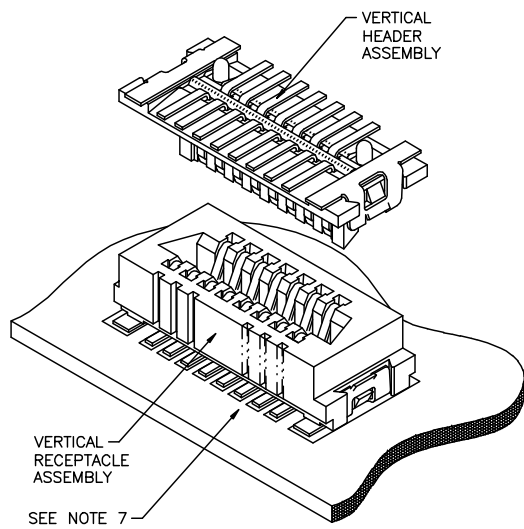
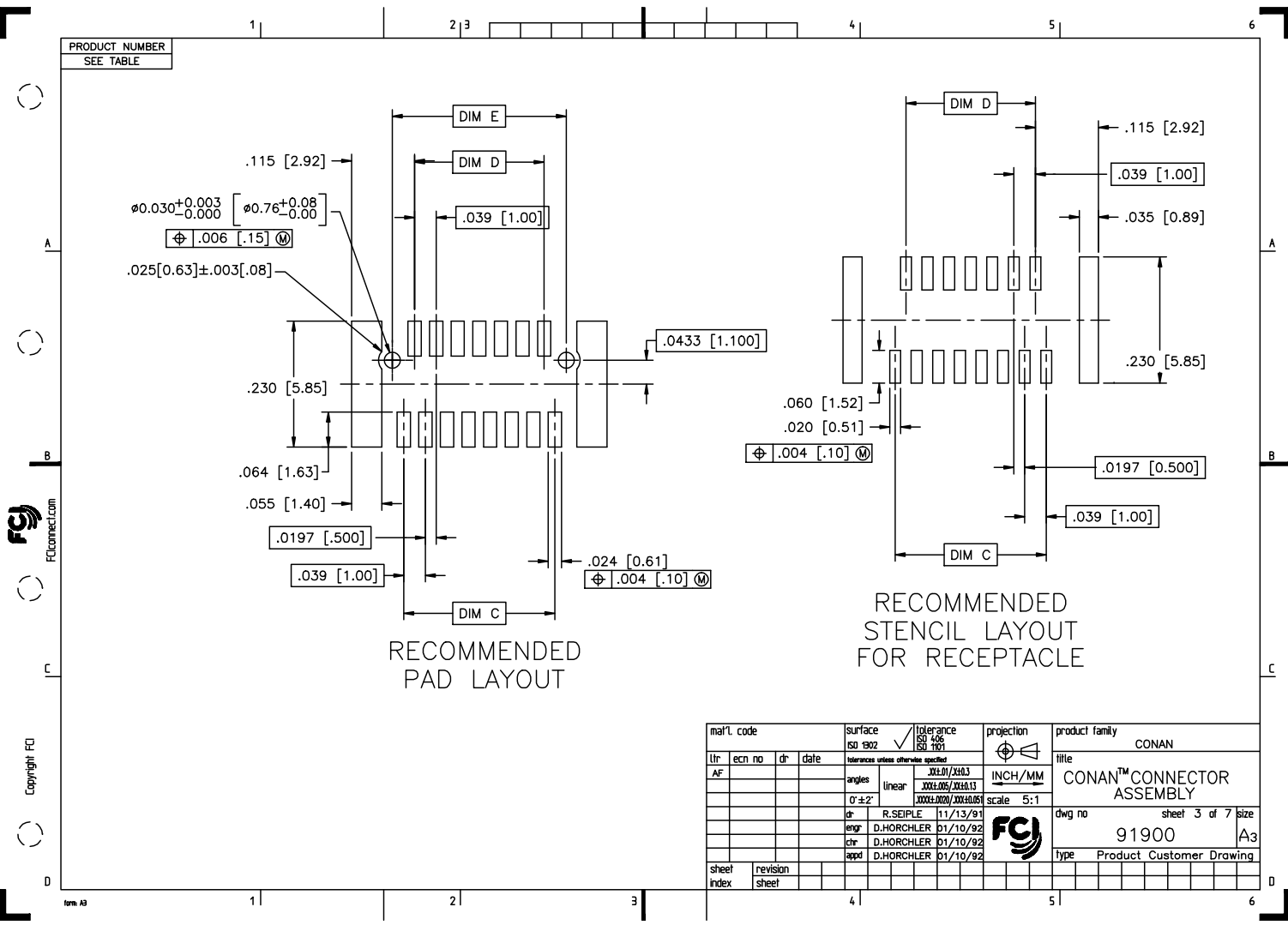

PRODUCT NUMBER
SEE TABLE

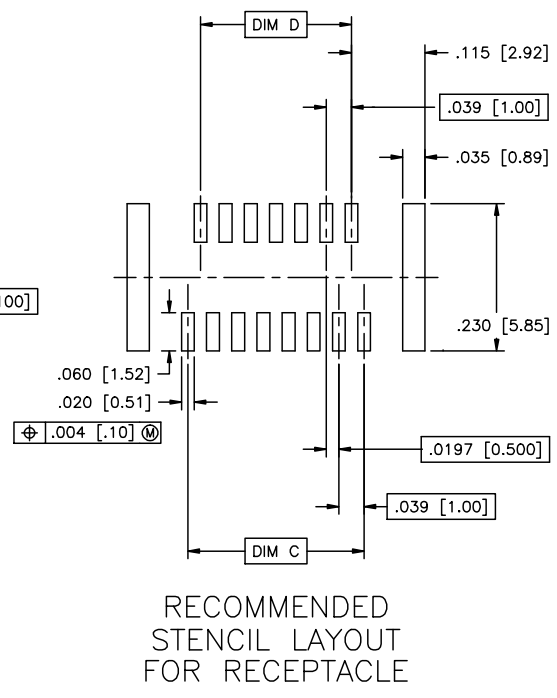
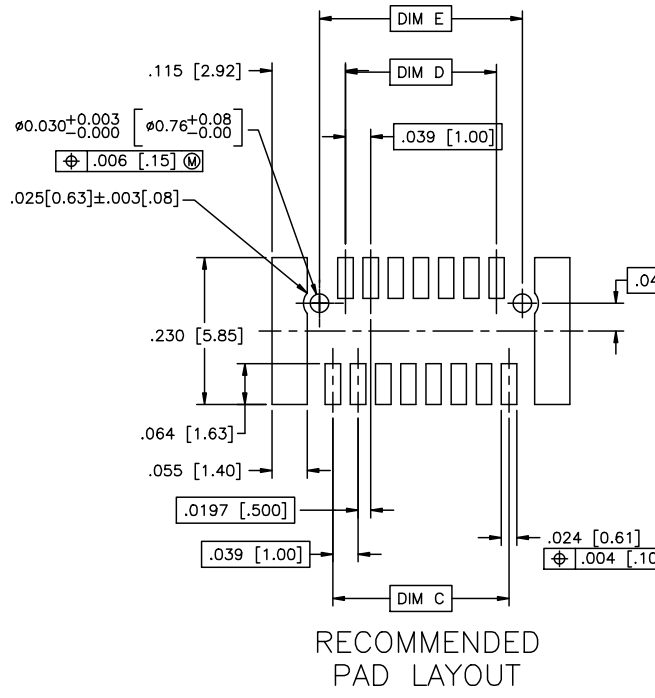

mal't. code		surface	tolerance	projection	product family
ISO 1902		ISO 1902	ISO 1902	ISO 1902	CONAN
ltr	ecm no	dr	date	title	
AF				CONAN™ CONNECTOR ASSEMBLY	
angles		linear	linear	INCH/MM	scale
0°±2'		XXX±.01/XXX±.03	XXX±.005/XXX±.013	INCH/MM	5:1
dr	R.SEIPLE	11/13/91		dwg no	
eng	D.HORCHLER	01/10/92		sheet 3 of 7	
chr	D.HORCHLER	01/10/92		size	
app	D.HORCHLER	01/10/92		A3	
sheet	revision			type	
index	sheet			Product Customer Drawing	

PRODUCT NUMBER
SEE TABLE

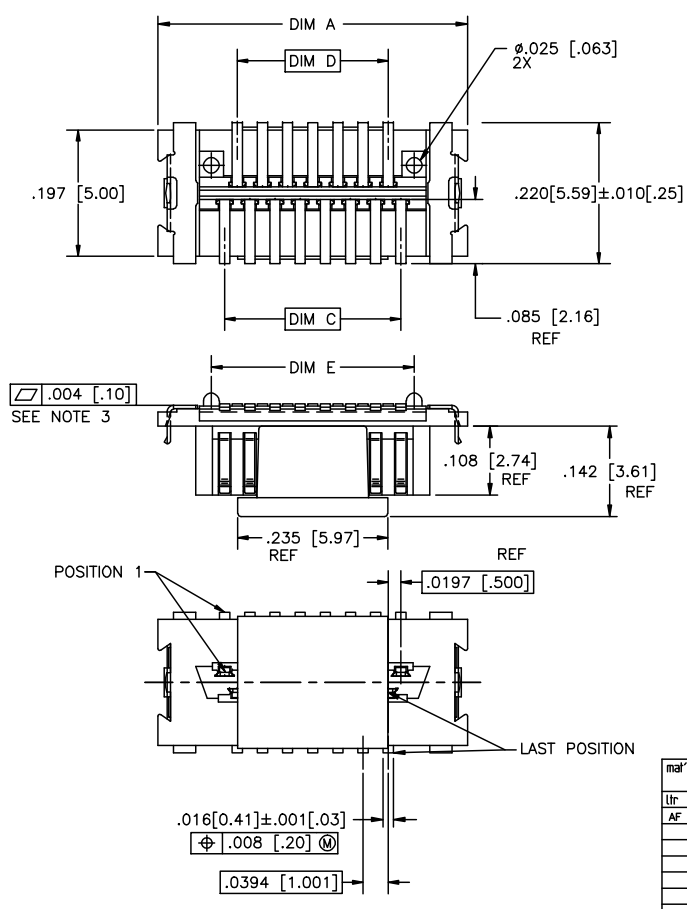

mal'l. code		surface		ISO 1902	tolerance	ISO 1436	ISO 1101	projection	product family
lit	ecm no	dr	date	tolerances unless otherwise specified				INCH/MM	CONAN
AF				angles	linear	XXX.01/XXX.03	scale 5:1		
				0'±2'		XXX±.005/XXX±0.13		CONAN™ CONNECTOR ASSEMBLY	
		dr	R. SEIPLE	11/13/91		XXX±.000/XXX±0.05		dwg no	sheet 4 of 7
		eng	D.HORCHLER	01/10/92				91900	A3
		chr	D.HORCHLER	01/10/92				type	Product Customer Drawing
		appd	D.HORCHLER	01/10/92					
sheet index	revision sheet								

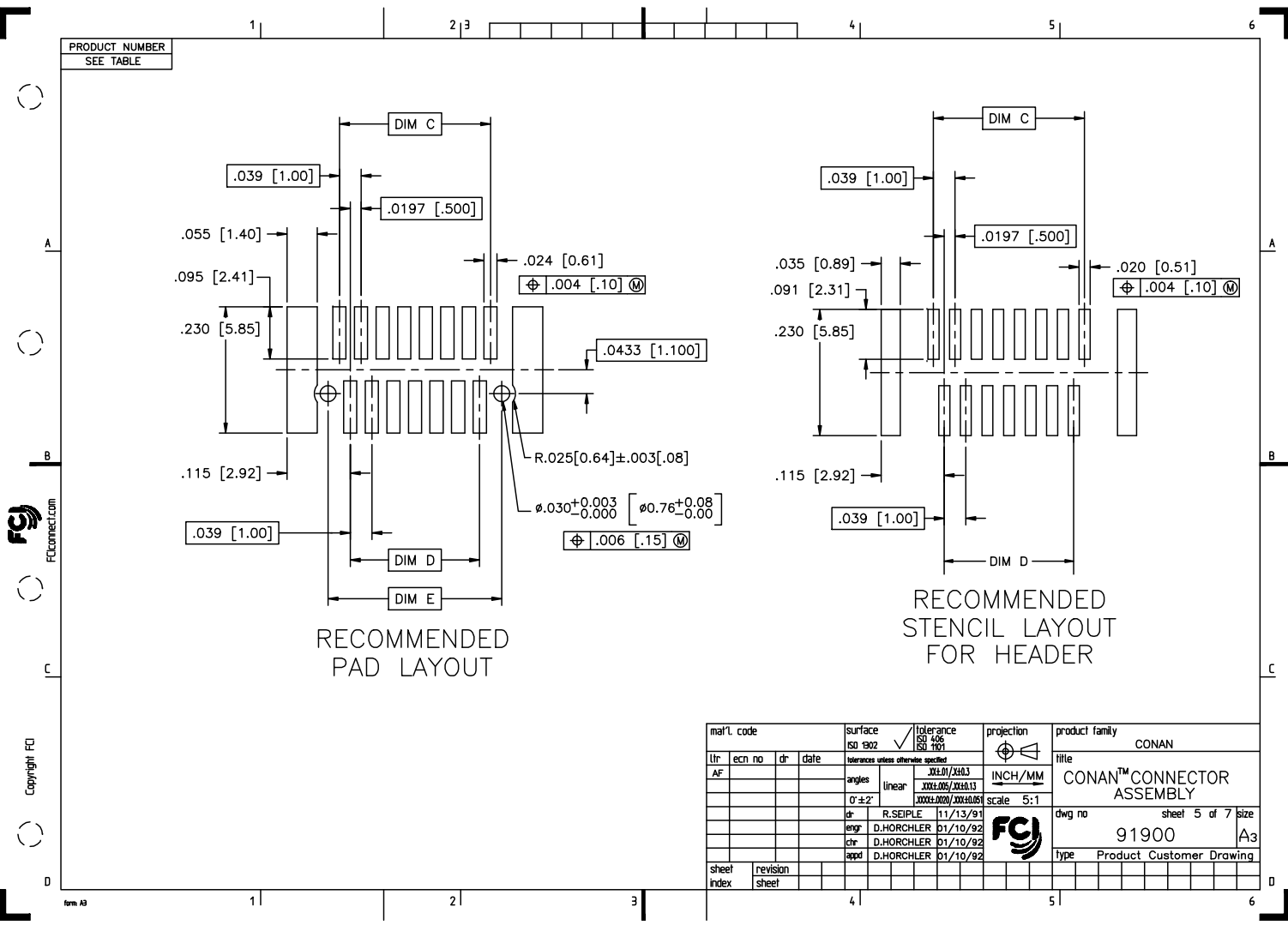

Copyright FCI

mal't. code		surface		tolerance		projection		product family	
ISO 1902		ISO 1436		ISO 1001		ASME Y14.5		CONAN	
ecn no		dr		date		INCH/MM		title	
AF						5:1		CONAN™ CONNECTOR ASSEMBLY	
angles		linear		XX±.01/XX±.03		scale		dwg no	
0°±2'		XXX±.005/XXX±.013		XXX±.005/XXX±.013		5:1		91900	
dr		engr		chr		appd		sheet 5 of 7	
R.SEIPLE 11/13/91		D.HORCHLER 01/10/92		D.HORCHLER 01/10/92		D.HORCHLER 01/10/92		size A3	
sheet		revision		sheet		type		Product Customer Drawing	
Index									

PRODUCT NUMBER	POS	DIM "A"	DIM "C"	DIM "D"	DIM "E"
919TC-WXY09					
↑ -WXY09LF	9	.366 [9.30]	.157 [4.00]	.118 [3.00]	.1990 [5.055]
-WXY11	11	.406 [10.30]	.197 [5.00]	.157 [4.00]	.2380 [6.045]
-WXY15	15	.484 [12.30]	.276 [7.00]	.236 [6.00]	.3170 [8.052]
-WXY21	21	.602 [15.30]	.394 [10.00]	.354 [9.00]	.4350 [11.049]
-WXY25	25	.681 [17.30]	.472 [12.00]	.433 [11.00]	.5140 [13.056]
-WXY31	31	.800 [20.30]	.591 [15.00]	.551 [14.00]	.6320 [16.053]
-WXY41	41	.996 [25.30]	.787 [20.00]	.748 [19.00]	.8290 [21.057]
-WXY51	51	1.193 [30.30]	.984 [25.00]	.945 [24.00]	1.0260 [26.060]
-WXY69	69	1.547 [39.30]	1.339 [34.00]	1.299 [33.00]	1.3800 [35.052]
↓ -WXY69LF					

NOTES:

- MATERIALS:
RECEPTACLE HOUSING - LCP, UL-94V-0. COLOR: NATURAL.
RECEPTACLE TERMINALS - COPPER ALLOY, PLATED WITH 15u"/.38u GXT™ IN CONTACT AREA AND 100u"/2.54u Sn ON SOLDER LEGS WITH AN OVERALL 50u"/1.27u Ni UNDERPLATE.
HEADER HOUSING - LCP, UL-94V-0. COLOR: NATURAL.
HEADER TERMINALS - COPPER ALLOY, PLATED WITH 15u"/.38u GXT™ IN CONTACT AREA AND 100u"/2.54u Sn ON SOLDER LEGS WITH AN OVERALL 50u"/1.27u Ni UNDERPLATE.
RETENTION DEVICE - BRASS, PLATED WITH 100u"/2.54u Sn OVER NICKEL.
- REFERENCE GS-12-006 FOR PRODUCT PERFORMANCE DATA.
- SEE TA-774 FOR FURTHER DESCRIPTION OF HOW THIS DIMENSION IS APPLIED.
- PICK AND PLACE CAP OR TAPE IS ONLY AVAILABLE WITH OPTION 3 PACKAGING. (PSA ADHESIVE SEALED). ALSO, PSA PACKAGING REQUIRES A PICK AND PLACE CAP.
- RECOMMENDED SOLDER PASTE THICKNESS IS .006 TO .008 INCHES THICK.
- THE TOE HEIGHT OF THE SOLDER TAIL SHALL BE MEASURED FROM THE LOWEST POINT OF THE .004 CO-PLANARITY GRAVITY PLANE. THIS MEASUREMENT IS NOT TO EXCEED A WINDOW OF .000 TO .007 INCHES.
- THREE SLOTS MAY BE LOCATED AT EITHER END OF HOUSING.
- 5.50mm MATED HEIGHT IS ONLY AVAILABLE IN 9, 15 AND 31 POS.
- 7.50mm MATED HEIGHT IS ONLY AVAILABLE IN 9 POS.
- APPLIES TO 91921-3XYZZ AND 91931-3XYZZ OPTIONS ONLY.
- THE HOUSING WILL WITHSTAND EXPOSURE TO 260°C PEAK TEMPERATURE FOR 30 SECONDS IN A CONVECTION INFRA RED OR VAPOR PHASE REFLOW OVEN. SEE APPLICATION/PROCEDURES IF THEY ARE AVAILABLE.
- PRODUCT WITH "LF" AT THE END MEETS EUROPEAN UNION DIRECTIVES AND OTHER COUNTRY REGULATION AS DESCRIBED IN GS-22-008.

mal'l. code	surface ISO 1902	tolerance ISO 406 ISO 1001	projection	product family CONAN
lfr	ecn no	dr	date	tolerances unless otherwise specified
AF				angles linear
				0°±2'
				dr R.SEIPLE 11/13/91
				engr D.HORCHLER 01/10/92
				chr D.HORCHLER 01/10/92
				appd D.HORCHLER 01/10/92
sheet	revision			
index	sheet			

title	CONAN™ CONNECTOR ASSEMBLY	
dwg no	91900	sheet 6 of 7 size A3
type	Product Customer Drawing	

PRODUCT NUMBER
SEE TABLE

CONAN ASSEMBLY PART NUMBER

919 T C - W X Y ZZ LF

LEAD FREE OPTION
SEE NOTE 12

TYPE	T
HEADER WITH NO PEGS	0
HEADER WITH PEGS	1
RECEPTACLE WITH NO PEGS	2
RECEPTACLE WITH PEGS	3

PICK AND PLACE CAP OR TAPE (NOTE 4)	C
WITHOUT CAP OR TAPE	0
WITH CAP	1
WITH TAPE (RECEPTACLE ONLY)	2

PACKAGING	W
TUBE	2
PRESSURE SEALED TAPE & REEL	3

NOTE 4

Y	HEADER HEIGHT	RECEPTACLE HEIGHT	MATED HEIGHT	+0.010 -0.008 [+.25] [-.20]
1	.034 [.86]	.129 [3.28]	.163 [4.15]	
2	.048 [1.23]		.177 [4.50]	
3	.068 [1.73]		.197 [5.00]	
4	.107 [2.72]		.236 [6.00]	
5	.1465 [3.721]		.276 [7.00]	
6	.088 [2.23]		.216 [5.50]	
7	.1665 [4.229]		.296 [7.52]	

SEE Y=1
FOR ALL
RECEPTACLES

* NOTE 8
** NOTE 9

X	PLATING
1	15u"/.38u GXT™
2	30u"/.76u GXT™

ZZ	NUMBER OF POSITIONS
09	9
11	11
15	15
21	21
25	25
31	31
41	41
51	51
69	69

EXAMPLE: 91921-31125LF
IS A CONAN RECEPTACLE ASSEMBLY,
HAVING NO PEGS AND WITH A PICK AND PLACE CAP.
IT ALSO HAS GXT™ PLATING, IS .13 [3.2] HIGH AND 25
POSITIONS AND IS PACKAGED IN PRESSURE SEALED TAPE,
REEL AND LEAD FREE.

mal'l. code	surface ISO 902	tolerance ISO 406 ISO 1001	projection	product family CONAN
lfr	ecn no	dr	date	title CONAN™ CONNECTOR ASSEMBLY
AF				dwg no 91900
	angles	linear	XX±.01/XX±0.3 XXX±.005/XX±0.13 XXXX±.000/XX±0.05	sheet 7 of 7 size A3
	0'±2'		scale 5:1	type Product Customer Drawing
	dr	R.SEIPLE	11/13/91	
	eng	D.HORCHLER	01/10/92	
	chr	D.HORCHLER	01/10/92	
	appd	D.HORCHLER	01/10/92	
sheet index	revision sheet			