

## Versatile easy-mount filter

## FN 420

- 0.6-6.5A current ratings
- low profile case
- designed for easy-mounting
- Nennströme von 0,6 bis 6,5 A
- Flaches Gehäuse
- Einfache Montage
- courants de service de 0,6 à 6,5 A
- boîtier à hauteur réduite
- conçu pour un montage simple



### Filter selection table

Choose the family FN xxx with the required current rating and features, and add /?? to determine input/output (line/load) connection style. Example: FN 422-4/13 is a 4A filter with mini fast-on connections.

### Approvals



Family	Connections 	Current ratings at 40°C (25°) A	Inductance L mH
FN 42? -0.6 /??	/13	0.6 (0.7)	22.5
FN 42? -1 /??	/13	1 (1.2)	13
FN 42? -2.5 /??	/13	2.5 (3)	3.4
FN 42? -4 /??	/13	4 (4.8)	2
FN 42? -6.5 /??	/13	6.5 (7.3)	0.75

### Additional specifications

Filter type	Capacitance		Res. R MΩ	Maximum leakage μA/phase	Maximum operating voltage		Operating frequency Hz	Hipot test voltage		Housing	Weight g
	Cx nF	Cy nF			VAC	Hz		PN→E VAC	P→N VDC		
FN 420 types	150	2.2	1	190	250	50/60	DC to 400	2000	1700	A7B	70
FN 422 types	150	4.7	1	190	250	50/60	DC to 400	2000	1700	A7B	70

MTBF at 40°C, 230V, per Mil-HB-217F: 625,000 hours.

### Electrical schematic

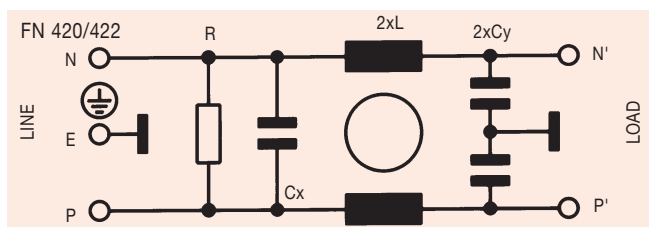

See tables for component values.

## FN 420 insertion loss

Per CISPR 17; A = 50Ω/50Ω sym, B = 50Ω/50Ω asym, C = 0.1Ω/100Ω sym, D = 100Ω/0.1Ω sym

### FN 420 0.6 amp types

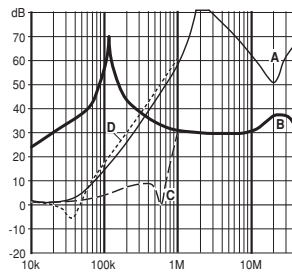

### FN 420 1 amp types

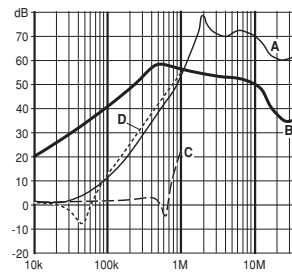

### FN 420 2.5 amp types

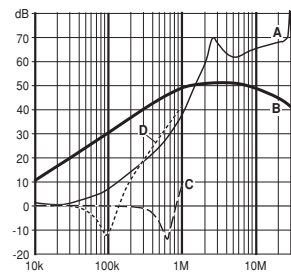

### FN 420 4 amp types

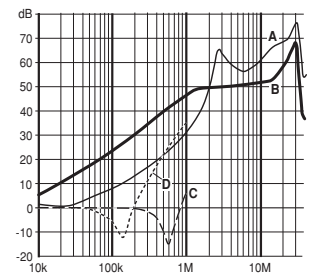

### FN 420 6.5 amp types

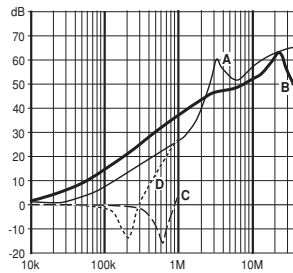

### FN 422 0.6 amp types

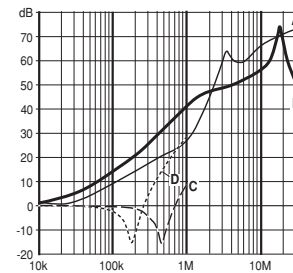

### FN 422 1 amp types

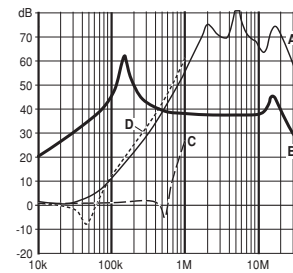

### FN 422 2.5 amp types

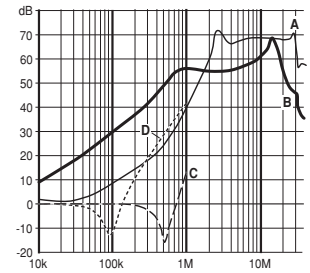

### FN 422 4 amp types

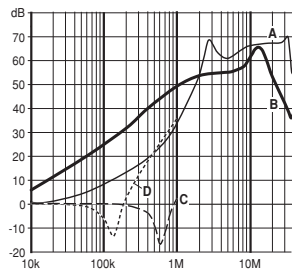

### FN 422 6.5 amp types

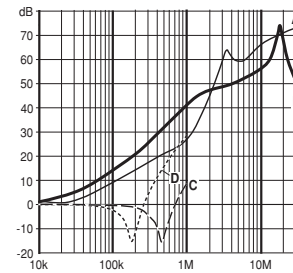

## Mechanical data

		Tol. mm
<b>A</b>	83	± 0.5
<b>B</b>	41	± 0.3
<b>C</b>	17	± 0.3
<b>D</b>	65.8	± 0.2
<b>E</b>	31	± 0.5
<b>F</b>	40	± 0.2
<b>G</b>	5.5	± 0.3
<b>J</b>	15.2	± 0.3
<b>K</b>	1	± 0.1
<b>M</b>	∅5	± 0.1

### FRONT VIEW

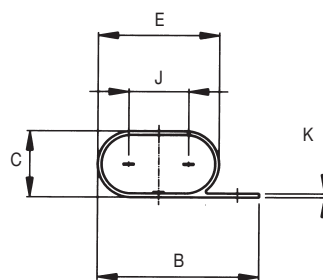

### TOP VIEW

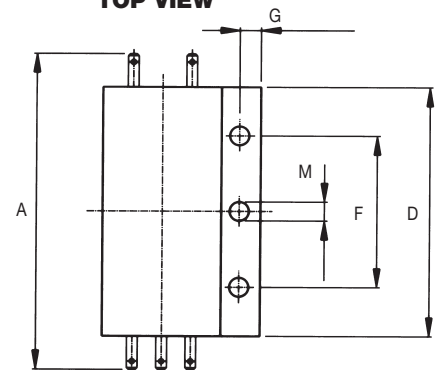

All dimensions in mm; 1 inch = 25.4 mm