



1-phase filters FN 350

Single-phase EMC/RFI filter for motor drives



- Compact filter solution for single-phase motor drive applications
- Industrial grade safety terminal blocks
- Designed to meet EN 55011/14/22
- Compliant with IEC 60950

Approvals



Technical specifications

Maximum continuous operating voltage:	1x 250VAC
Operating frequency:	dc to 400Hz
Rated currents:	8 to 55A @ 40°C
High potential test voltage:	P → E 2000VAC for 2 sec
	P → N 1100VDC for 2 sec
Protection category:	IP20
Overload capability:	4x rated current at switch on, 1.5x rated current for 1 minute, once per hour
Temperature range (operation and storage):	-25°C to +100°C (25/100/21)
Flammability corresponding to:	UL 94V-2 or better
Design corresponding to:	UL 1283, CSA 22.2 No. 8 1986, IEC/EN 60939
MTBF @ 40°C/230V (Mil-HB-217F):	420,000 hours

Typical electrical schematic

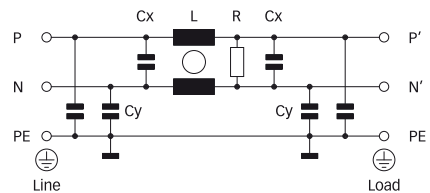

Features and benefits

- High component values optimized for common and differential-mode attenuation in the lower frequency range makes this filter ideal for a large variety of single-phase motor drive applications.
- Supplied in a relatively small housing design with safety terminal blocks for fast and easy installation in primarily industrial environments.
- FN 350 also meets IEC 60950 requirements, thus providing additional application flexibility.

Typical applications

- Single-phase motor drives
- Automation equipment
- Power supplies, SMPS
- Office equipment
- Testing and measurements equipment

Filter selection table

Filter	Rated current @ 40°C (25°C)	Leakage current* @ 230VAC/50Hz	Power loss @ 25°C/50Hz	Input/Output connections	Weight
	[A]	[mA]	[W]		[kg]
FN 350-8-29	8 (9.0)	4.9	5.2	-29	0.7
FN 350-12-29	12 (13.5)	4.9	5.7	-29	0.7
FN 350-20-29	20 (22.4)	4.9	6.1	-29	0.7
FN 350-30-33	30 (33.6)	5.4	6.1	-33	0.7
FN 350-55-33	55 (61.5)	11.0	9.9	-33	1.2

* Maximum leakage under normal operating conditions. Note: if the neutral line is interrupted, worst case leakage could reach twice this level.

Typical filter attenuation

Per CISPR 17; A = 50Ω/50Ω sym; B = 50Ω/50Ω asym; C = 0.1Ω/100Ω sym; D = 100Ω/0.1Ω sym

8A types

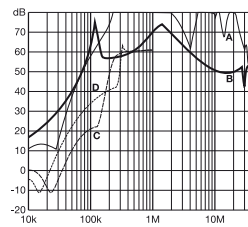

12A types

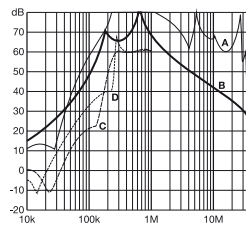

20 and 30A types

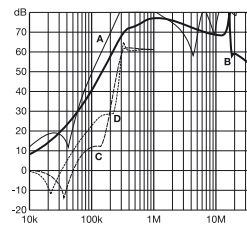

55A types

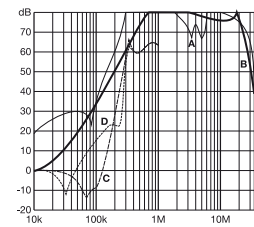

Mechanical data

8 to 30A types

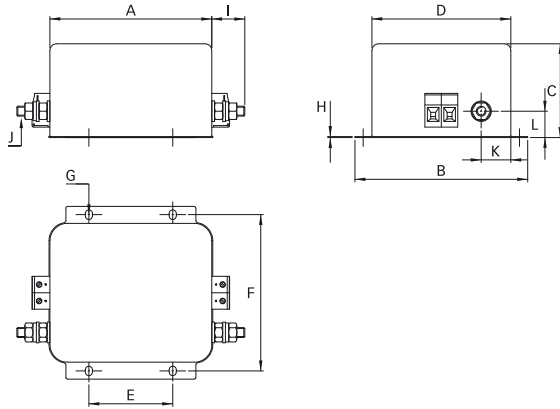

55A types

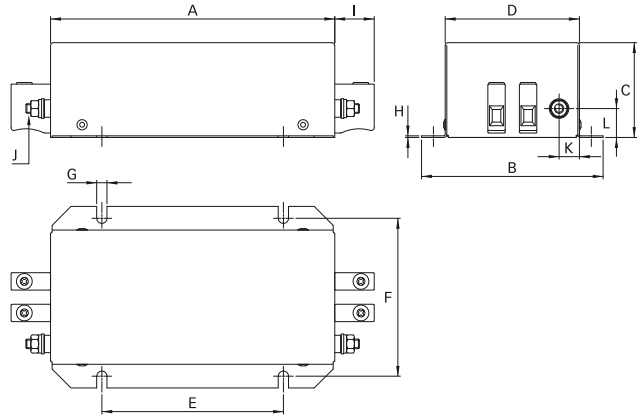

Dimensions

	8A	12A	20A	30A	55A
A	99.5	99.5	99.5	99.5	180
B	105	105	105	105	115
C	57	57	57	57.6	60
D	84.4	84.4	84.4	84.4	85
E	51	51	51	51	115
F	95	95	95	95	100
G	6 x 4.4	6 x 4.4	6 x 4.4	6 x 4.4	6.5
H	0.6	0.6	0.6	1.2	1
I	19.5	19.5	19.5	25	25
J	M6	M6	M6	M6	M6
K	18	18	18	16	12.9
L	16	16	16	19	18.3

All dimensions in mm; 1 inch = 25.4mm
Tolerances according: ISO 2768-m / EN 22768-m

Filter input/output connector cross sections

	-29	-33
Solid wire	6mm ²	16mm ²
Flex wire	4mm ²	10mm ²
AWG type wire	AWG 10	AWG 6
Recommended torque	0.6 - 0.8Nm	1.5 - 1.8Nm