

Inlet filter, front- or rear side mounting, line switch 1-/2-pole

Standard- or Medical-Filter

new

Screw-On Version  
from front sideSnap-In Version  
from front sideScrew-On Version  
from rear side

C14

70° C

**Description**

- Panel Mount:  
Screw-on version from front or rear side, snap-in version from front side
- 3 Functions:  
Appliance Inlet Protection class I, Line switch 1- or 2-pole, Line filter in standard and medical version
- Quick connect terminals 6.3 x 0.8 mm
- Alternative: version without line filter [DC11](#)
- Substitute for type [KFB1](#); [KFB2](#)

**Approvals**

- VDE License Number: 40001522
- UL License Number: E72928

**Characteristics**

- Compact design with optimal shielding
- Rear side mounting for efficient cost-saving assembly
- All single elements are already wired
- Line switch non-illuminated or illuminated
- Marquard switch for high inrush currents
- Universal line filter for standard applications
- Ideal for application with high transient loads
- Qualified for use in equipment according to IEC/EN 60950

**Other versions on request**

- Solder terminals
- Other rocker marking
- Capacitance CX1

**References**

[General Product Information](#)

**Weblinks**

[Approvals](#), [RoHS](#), [CHINA-RoHS](#), [e-Store](#), [SCHURTER-Stock-Check](#), [Distributor-Stock-Check](#)

**Technical Data**

Ratings IEC	1 - 10A @ Ta 40 °C / 250VAC; 50Hz
Ratings UL/CSA	1 - 10A @ Ta 40 °C / 125VAC; 60Hz
Leakage Current	standard < 0.5mA (250V / 60Hz) medical < 5 µA (250 V / 60 Hz)
Dielectric Strength	> 1.7 kVDC between L-N > 2.7 kVDC between L/N-PE Test voltage (2 sec)
Allowable Operation Temp.	-25 °C to 85 °C
Climatic Category	25/085/21 acc. to IEC 60068-1
Degree of Protection	from front side IP 40 acc. to IEC 60529
Protection Class	Suitable for appliances with protection class I acc. to IEC 61140
Terminal	Quick connect terminals 6.3 x 0.8 mm
Panel Thickness s	Screw-on: max 8 mm Mounting screw torque max 0.5 Nm Snap-in: 1 mm to 3 mm
Material: Housing	Thermoplastic, black, UL 94V-0

Appliance-Inlet/-Outlet	C14 acc. to IEC/EN 60320-1, UL 498, CSA C22.2 no. 42 (for cold conditions) pin-temperature 70 °C, 10A, Protection class I
Line Switch	Rocker switch 1 or 2 pole, non-illuminated or illuminated, acc. to IEC 61058-1 <a href="#">Technical details</a>
Line Filter	Standard and Medical Version, IEC 60939, IEC 60601-1, UL 1283, UL 544, EN 133 200, CSA C22.2 no. 8 <a href="#">Technical details</a>
MTBF	> 1'900'000h acc. to MIL-HB-217 F

### Dimensions

Screw-on mounting from front side

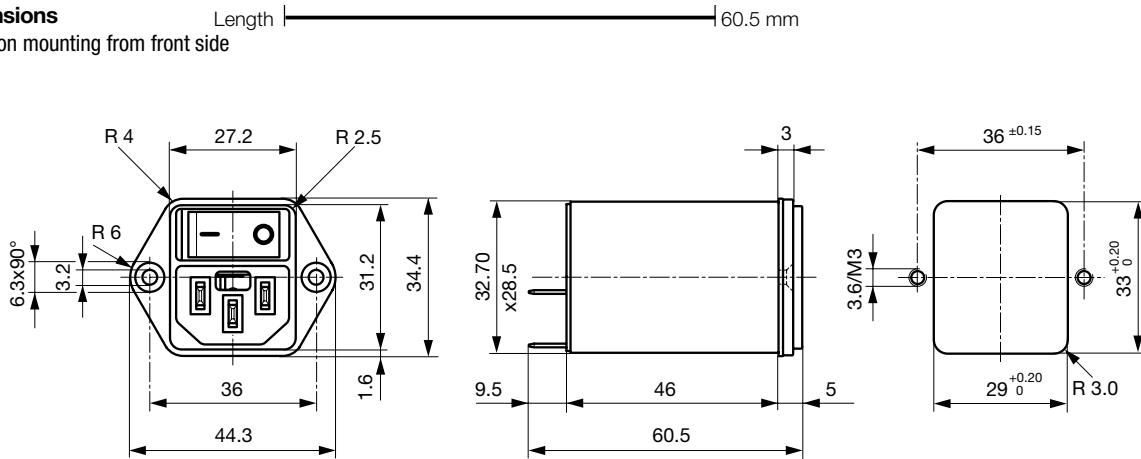

Screw-On Version from rear side (metal flange)

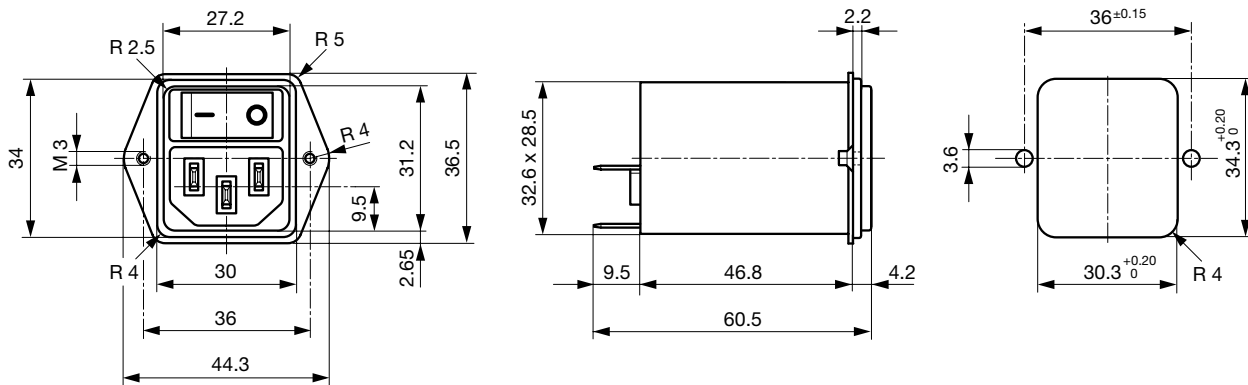

Snap-in mounting from front side

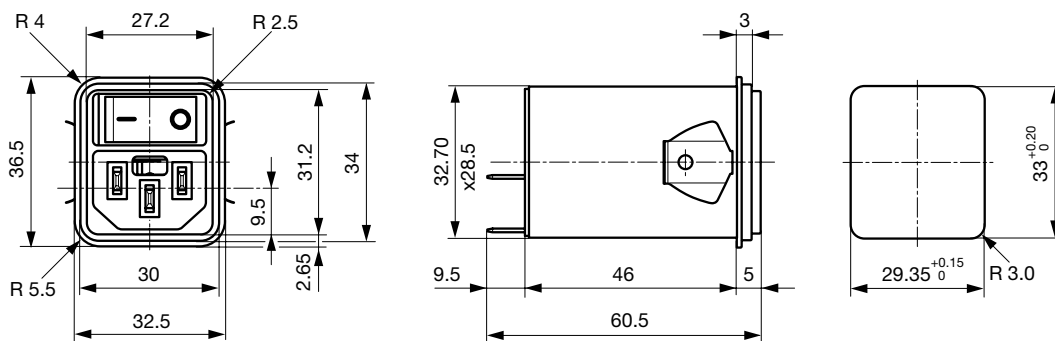

Technical Data of Filter-Components

Rated Current [A]	Filter-Type	Inductances L [mH]	Capacitance CX [nF]	Capacitance CY [nF]	R [MΩ]
1	Standard Version	2 x 10	100	2.2	1
2	Standard Version	2 x 4	100	2.2	1
4	Standard Version	2 x 1.5	100	2.2	1
6	Standard Version	2 x 0.8	100	2.2	1
10	Standard Version	2 x 0.3	100	2.2	1
1	Medical Version (M5)	2 x 10	100	-	1
2	Medical Version (M5)	2 x 4	100	-	1
4	Medical Version (M5)	2 x 1.5	100	-	1
6	Medical Version (M5)	2 x 0.8	100	-	1
10	Medical Version (M5)	2 x 0.3	100	-	1
1	Medical Version (M80)	2 x 10	100	0.47	1
2	Medical Version (M80)	2 x 4	100	0.47	1
4	Medical Version (M80)	2 x 1.5	100	0.47	1
6	Medical Version (M80)	2 x 0.8	100	0.47	1
10	Medical Version (M80)	2 x 0.3	100	0.47	1

Diagrams

Standard filter 1-pole

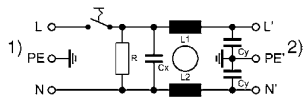

- 1) Line
- 2) Load

Standard filter 2-pole illuminated

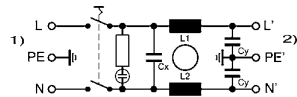

- 1) Line
- 2) Load

Standard filter 2-pole

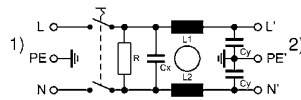

- 1) Line
- 2) Load

Medical Filter 2-pole (M5) illuminated

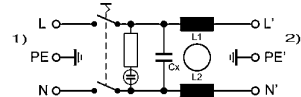

- 1) Line
- 2) Load

Medical filter 1-pole (M5)

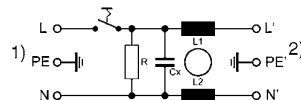

- 1) Line
- 2) Load

Medical filter 2-pole (M5)

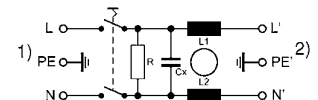

Attenuation Loss

--- differential mode \_\_\_\_ common mode

Standard version

1 A

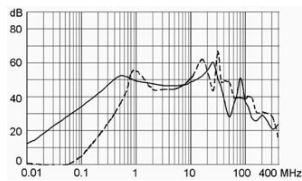

2 A

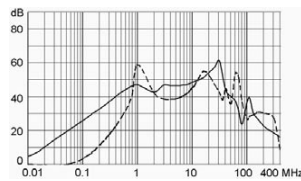

4 A

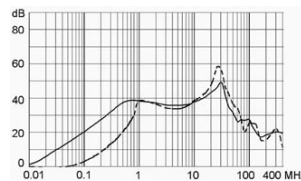

6 A

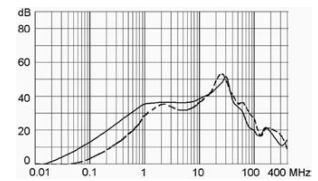

10 A

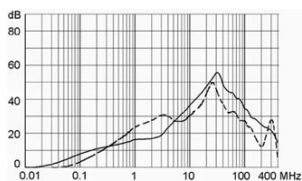

Medical version (M5)

1 A

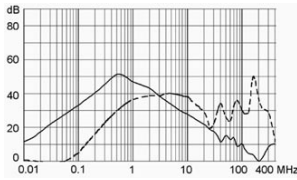

2 A

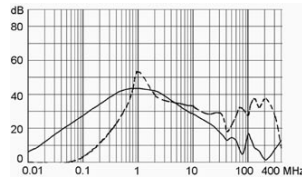

4 A

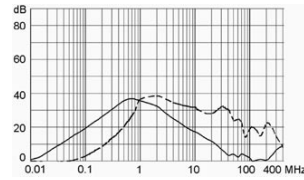

6 A

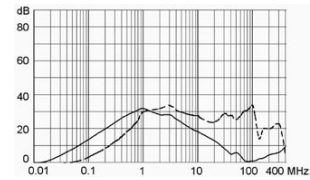

10 A

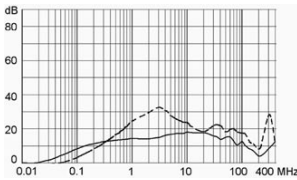

## Variants

[Distributor-Stock-Check](#) | [SCHURTER-Stock-Check](#) | [e-Store](#)

Rated Current [A]	Filter-Type	Panel mounting	Mounting side	Line Switch	Illumination	Color	Order Number
1	Standard Version	Screw-on	Front-Side	1 pole	non-illuminated	-	DC12.1102.003
2	Standard Version	Screw-on	Front-Side	1 pole	non-illuminated	-	DC12.2102.003
4	Standard Version	Screw-on	Front-Side	1 pole	non-illuminated	-	DC12.3102.003
6	Standard Version	Screw-on	Front-Side	1 pole	non-illuminated	-	DC12.4102.003
10	Standard Version	Screw-on	Front-Side	1 pole	non-illuminated	-	DC12.5102.003
1	Standard Version	Screw-on	Front-Side	1 pole	illuminated	red	DC12.1122.003
1	Standard Version	Screw-on	Front-Side	1 pole	illuminated	green	DC12.1132.003
2	Standard Version	Screw-on	Front-Side	1 pole	illuminated	red	DC12.2122.003
2	Standard Version	Screw-on	Front-Side	1 pole	illuminated	green	DC12.2132.003
4	Standard Version	Screw-on	Front-Side	1 pole	illuminated	red	DC12.3122.003
4	Standard Version	Screw-on	Front-Side	1 pole	illuminated	green	DC12.3132.003
6	Standard Version	Screw-on	Front-Side	1 pole	illuminated	red	DC12.4122.003
6	Standard Version	Screw-on	Front-Side	1 pole	illuminated	green	DC12.4132.003
10	Standard Version	Screw-on	Front-Side	1 pole	illuminated	red	DC12.5122.003
10	Standard Version	Screw-on	Front-Side	1 pole	illuminated	green	DC12.5132.003
1	Standard Version	Screw-on	Front-Side	2-pole	non-illuminated	-	DC12.1102.001
2	Standard Version	Screw-on	Front-Side	2-pole	non-illuminated	-	DC12.2102.001
4	Standard Version	Screw-on	Front-Side	2-pole	non-illuminated	-	DC12.3102.001
6	Standard Version	Screw-on	Front-Side	2-pole	non-illuminated	-	DC12.4102.001
10	Standard Version	Screw-on	Front-Side	2-pole	non-illuminated	-	DC12.5102.001
1	Standard Version	Screw-on	Front-Side	2-pole	illuminated	red	DC12.1122.001
1	Standard Version	Screw-on	Front-Side	2-pole	illuminated	green	DC12.1132.001
2	Standard Version	Screw-on	Front-Side	2-pole	illuminated	red	DC12.2122.001
2	Standard Version	Screw-on	Front-Side	2-pole	illuminated	green	DC12.2132.001
4	Standard Version	Screw-on	Front-Side	2-pole	illuminated	red	DC12.3122.001
4	Standard Version	Screw-on	Front-Side	2-pole	illuminated	green	DC12.3132.001
6	Standard Version	Screw-on	Front-Side	2-pole	illuminated	red	DC12.4122.001
6	Standard Version	Screw-on	Front-Side	2-pole	illuminated	green	DC12.4132.001
10	Standard Version	Screw-on	Front-Side	2-pole	illuminated	red	DC12.5122.001
10	Standard Version	Screw-on	Front-Side	2-pole	illuminated	green	DC12.5132.001
1	Standard Version	Screw-on	Rear-Side	1 pole	non-illuminated	-	DC12.1102.203
2	Standard Version	Screw-on	Rear-Side	1 pole	non-illuminated	-	DC12.2102.203
4	Standard Version	Screw-on	Rear-Side	1 pole	non-illuminated	-	DC12.3102.203
6	Standard Version	Screw-on	Rear-Side	1 pole	non-illuminated	-	DC12.4102.203
10	Standard Version	Screw-on	Rear-Side	1 pole	non-illuminated	-	DC12.5102.203
1	Standard Version	Screw-on	Rear-Side	2-pole	non-illuminated	-	DC12.1102.201

Rated Current [A]	Filter-Type	Panel mounting	Mounting side	Line Switch	Illumination	Color	Order Number
2	Standard Version	Screw-on	Rear-Side	2-pole	non-illuminated	-	DC12.2102.201
4	Standard Version	Screw-on	Rear-Side	2-pole	non-illuminated	-	DC12.3102.201
6	Standard Version	Screw-on	Rear-Side	2-pole	non-illuminated	-	DC12.4102.201
10	Standard Version	Screw-on	Rear-Side	2-pole	non-illuminated	-	DC12.5102.201
1	Standard Version	Snap-in	Front-Side	1 pole	non-illuminated	-	DC12.1102.103
2	Standard Version	Snap-in	Front-Side	1 pole	non-illuminated	-	DC12.2102.103
4	Standard Version	Snap-in	Front-Side	1 pole	non-illuminated	-	DC12.3102.103
6	Standard Version	Snap-in	Front-Side	1 pole	non-illuminated	-	DC12.4102.103
10	Standard Version	Snap-in	Front-Side	1 pole	non-illuminated	-	DC12.5102.103
1	Standard Version	Snap-in	Front-Side	1 pole	illuminated	red	DC12.1122.103
1	Standard Version	Snap-in	Front-Side	1 pole	illuminated	green	DC12.1132.103
2	Standard Version	Snap-in	Front-Side	1 pole	illuminated	red	DC12.2122.103
2	Standard Version	Snap-in	Front-Side	1 pole	illuminated	green	DC12.2132.103
4	Standard Version	Snap-in	Front-Side	1 pole	illuminated	red	DC12.3122.103
4	Standard Version	Snap-in	Front-Side	1 pole	illuminated	green	DC12.3132.103
6	Standard Version	Snap-in	Front-Side	1 pole	illuminated	red	DC12.4122.103
6	Standard Version	Snap-in	Front-Side	1 pole	illuminated	green	DC12.4132.103
10	Standard Version	Snap-in	Front-Side	1 pole	illuminated	red	DC12.5122.103
10	Standard Version	Snap-in	Front-Side	1 pole	illuminated	green	DC12.5132.103
1	Standard Version	Snap-in	Front-Side	2-pole	non-illuminated	-	DC12.1102.101
2	Standard Version	Snap-in	Front-Side	2-pole	non-illuminated	-	DC12.2102.101
4	Standard Version	Snap-in	Front-Side	2-pole	non-illuminated	-	DC12.3102.101
6	Standard Version	Snap-in	Front-Side	2-pole	non-illuminated	-	DC12.4102.101
10	Standard Version	Snap-in	Front-Side	2-pole	non-illuminated	-	DC12.5102.101
1	Standard Version	Snap-in	Front-Side	2-pole	illuminated	red	DC12.1122.101
1	Standard Version	Snap-in	Front-Side	2-pole	illuminated	green	DC12.1132.101
2	Standard Version	Snap-in	Front-Side	2-pole	illuminated	red	DC12.2122.101
2	Standard Version	Snap-in	Front-Side	2-pole	illuminated	green	DC12.2132.101
4	Standard Version	Snap-in	Front-Side	2-pole	illuminated	red	DC12.3122.101
4	Standard Version	Snap-in	Front-Side	2-pole	illuminated	green	DC12.3132.101
6	Standard Version	Snap-in	Front-Side	2-pole	illuminated	red	DC12.4122.101
6	Standard Version	Snap-in	Front-Side	2-pole	illuminated	green	DC12.4132.101
10	Standard Version	Snap-in	Front-Side	2-pole	illuminated	red	DC12.5122.101
10	Standard Version	Snap-in	Front-Side	2-pole	illuminated	green	DC12.5132.101
1	Medical Version (M5)	Screw-on	Front-Side	1 pole	non-illuminated	-	DC12.1202.003
2	Medical Version (M5)	Screw-on	Front-Side	1 pole	non-illuminated	-	DC12.2202.003
4	Medical Version (M5)	Screw-on	Front-Side	1 pole	non-illuminated	-	DC12.3202.003
6	Medical Version (M5)	Screw-on	Front-Side	1 pole	non-illuminated	-	DC12.4202.003
10	Medical Version (M5)	Screw-on	Front-Side	1 pole	non-illuminated	-	DC12.5202.003
1	Medical Version (M5)	Screw-on	Front-Side	1 pole	illuminated	red	DC12.1222.003
1	Medical Version (M5)	Screw-on	Front-Side	1 pole	illuminated	green	DC12.1232.003
2	Medical Version (M5)	Screw-on	Front-Side	1 pole	illuminated	red	DC12.2222.003
2	Medical Version (M5)	Screw-on	Front-Side	1 pole	illuminated	green	DC12.2232.003
4	Medical Version (M5)	Screw-on	Front-Side	1 pole	illuminated	red	DC12.3222.003
4	Medical Version (M5)	Screw-on	Front-Side	1 pole	illuminated	green	DC12.3232.003
6	Medical Version (M5)	Screw-on	Front-Side	1 pole	illuminated	red	DC12.4222.003
6	Medical Version (M5)	Screw-on	Front-Side	1 pole	illuminated	green	DC12.4232.003
10	Medical Version (M5)	Screw-on	Front-Side	1 pole	illuminated	red	DC12.5222.003
10	Medical Version (M5)	Screw-on	Front-Side	1 pole	illuminated	green	DC12.5232.003
1	Medical Version (M5)	Screw-on	Front-Side	2-pole	non-illuminated	-	DC12.1202.001
2	Medical Version (M5)	Screw-on	Front-Side	2-pole	non-illuminated	-	DC12.2202.001
4	Medical Version (M5)	Screw-on	Front-Side	2-pole	non-illuminated	-	DC12.3202.001
6	Medical Version (M5)	Screw-on	Front-Side	2-pole	non-illuminated	-	DC12.4202.001
10	Medical Version (M5)	Screw-on	Front-Side	2-pole	non-illuminated	-	DC12.5202.001
1	Medical Version (M5)	Screw-on	Front-Side	2-pole	illuminated	red	DC12.1222.001

Rated Current [A]	Filter-Type	Panel mounting	Mounting side	Line Switch	Illumination	Color	Order Number
1	Medical Version (M5)	Screw-on	Front-Side	2-pole	illuminated	green	DC12.1232.001
2	Medical Version (M5)	Screw-on	Front-Side	2-pole	illuminated	red	DC12.2222.001
2	Medical Version (M5)	Screw-on	Front-Side	2-pole	illuminated	green	DC12.2232.001
4	Medical Version (M5)	Screw-on	Front-Side	2-pole	illuminated	red	DC12.3222.001
4	Medical Version (M5)	Screw-on	Front-Side	2-pole	illuminated	green	DC12.3232.001
6	Medical Version (M5)	Screw-on	Front-Side	2-pole	illuminated	red	DC12.4222.001
6	Medical Version (M5)	Screw-on	Front-Side	2-pole	illuminated	green	DC12.4232.001
10	Medical Version (M5)	Screw-on	Front-Side	2-pole	illuminated	red	DC12.5222.001
10	Medical Version (M5)	Screw-on	Front-Side	2-pole	illuminated	green	DC12.5232.001
1	Medical Version (M5)	Screw-on	Rear-Side	2-pole	non-illuminated	-	DC12.1202.201
2	Medical Version (M5)	Screw-on	Rear-Side	2-pole	non-illuminated	-	DC12.2202.201
4	Medical Version (M5)	Screw-on	Rear-Side	2-pole	non-illuminated	-	DC12.3202.201
6	Medical Version (M5)	Screw-on	Rear-Side	2-pole	non-illuminated	-	DC12.4202.201
10	Medical Version (M5)	Screw-on	Rear-Side	2-pole	non-illuminated	-	DC12.5202.201
1	Medical Version (M5)	Snap-in	Front-Side	1 pole	non-illuminated	-	DC12.1202.103
2	Medical Version (M5)	Snap-in	Front-Side	1 pole	non-illuminated	-	DC12.2202.103
4	Medical Version (M5)	Snap-in	Front-Side	1 pole	non-illuminated	-	DC12.3202.103
6	Medical Version (M5)	Snap-in	Front-Side	1 pole	non-illuminated	-	DC12.4202.103
10	Medical Version (M5)	Snap-in	Front-Side	1 pole	non-illuminated	-	DC12.5202.103
1	Medical Version (M5)	Snap-in	Front-Side	1 pole	illuminated	red	DC12.1222.103
1	Medical Version (M5)	Snap-in	Front-Side	1 pole	illuminated	green	DC12.1232.103
2	Medical Version (M5)	Snap-in	Front-Side	1 pole	illuminated	red	DC12.2222.103
2	Medical Version (M5)	Snap-in	Front-Side	1 pole	illuminated	green	DC12.2232.103
4	Medical Version (M5)	Snap-in	Front-Side	1 pole	illuminated	red	DC12.3222.103
4	Medical Version (M5)	Snap-in	Front-Side	1 pole	illuminated	green	DC12.3232.103
6	Medical Version (M5)	Snap-in	Front-Side	1 pole	illuminated	red	DC12.4222.103
6	Medical Version (M5)	Snap-in	Front-Side	1 pole	illuminated	green	DC12.4232.103
10	Medical Version (M5)	Snap-in	Front-Side	1 pole	illuminated	red	DC12.5222.103
10	Medical Version (M5)	Snap-in	Front-Side	1 pole	illuminated	green	DC12.5232.103
1	Medical Version (M5)	Snap-in	Front-Side	2-pole	non-illuminated	-	DC12.1202.101
2	Medical Version (M5)	Snap-in	Front-Side	2-pole	non-illuminated	-	DC12.2202.101
4	Medical Version (M5)	Snap-in	Front-Side	2-pole	non-illuminated	-	DC12.3202.101
6	Medical Version (M5)	Snap-in	Front-Side	2-pole	non-illuminated	-	DC12.4202.101
10	Medical Version (M5)	Snap-in	Front-Side	2-pole	non-illuminated	-	DC12.5202.101
1	Medical Version (M5)	Snap-in	Front-Side	2-pole	illuminated	red	DC12.1222.101
1	Medical Version (M5)	Snap-in	Front-Side	2-pole	illuminated	green	DC12.1232.101
2	Medical Version (M5)	Snap-in	Front-Side	2-pole	illuminated	red	DC12.2222.101
2	Medical Version (M5)	Snap-in	Front-Side	2-pole	illuminated	green	DC12.2232.101
4	Medical Version (M5)	Snap-in	Front-Side	2-pole	illuminated	red	DC12.3222.101
4	Medical Version (M5)	Snap-in	Front-Side	2-pole	illuminated	green	DC12.3232.101
6	Medical Version (M5)	Snap-in	Front-Side	2-pole	illuminated	red	DC12.4222.101
10	Medical Version (M5)	Snap-in	Front-Side	2-pole	illuminated	red	DC12.5222.101
10	Medical Version (M5)	Snap-in	Front-Side	2-pole	illuminated	green	DC12.5232.101
1	Medical Version (M80)	Screw-on	Rear-Side	2-pole	non-illuminated	-	DC12.1602.201
2	Medical Version (M80)	Screw-on	Rear-Side	2-pole	non-illuminated	-	DC12.2602.201
4	Medical Version (M80)	Screw-on	Rear-Side	2-pole	non-illuminated	-	DC12.3602.201
6	Medical Version (M80)	Screw-on	Rear-Side	2-pole	non-illuminated	-	DC12.4602.201
10	Medical Version (M80)	Screw-on	Rear-Side	2-pole	non-illuminated	-	DC12.5602.201

Packaging unit 10 Pcs