

BASIC PART NUMBER:

10017657-**2****0****X****X****X** — **X** L F

RoHS COMPLIANT SPECIFICATION (SEE NOTE 4)  
 OPTION  
 (BLANK : NO CUSTOMIZATION)  
 (  : CUSTOMIZED REQUEST)

CARDBUS:  0 — NO  
 1 — YES

INSULATOR:  0 — NO  
 1 — FCI LONG  
 2 — FCI SHORT  
 3 — CUSTOMIZED

LABEL RECESS:  0 — NO  
 1 — YES(LONG, 66x42mm)  
 2 — YES(SHORT, 63x42mm)

OPEN END

CARD TYPE: II

NOTES:

- CARDSHIELD: STAINLESS STEEL, THICKNESS 0.2MM, SURFACE FINISH: MATTE.
- FRAME BAR: PPO OR PA46, COLOR BLACK, UL94V-0.
- INSULATOR: POLYESTER FILM WITH ADHESIVE, 3M 1350 OR EQUIVALENT.
- 10017657-20XXX-XX IS SIMILAR TO 10017657-20XXX-XLF THE SUFFIX " LF " IS ADDED FOR LEAD FREE IDENTIFICATION, THIS PRODUCT MEETS EUROPEAN UNION DIRECTIVES AND OTHER COUNTRY REGULATIONS AS PER GS-22-008.
- PACKING SPEC. PER GS-14-775.

mat'l code		tolerance unless otherwise specified		CUSTOMER COPY	 www.fciconnect.com										
rev.	ecn no.	dr	date	linear	projection	title									
C	T03-0111	WL	04/03/03												
D	T03-0290	WL	07/15/03	angles		product family PCMCIA code size dwg no. 10017657									
E	T03-0314	WL	08/05/03												
F	T06-0056	WL	04/03/06	dr	WENDY CHEN	10/21/02									
G	T06-0093	WL	05/10/06	enrg	DAVID TENG	10/21/02									
H	T06-0134	WL	07/12/06	chr	TONY CHIEN	10/21/02									
				appd	JENN TSAO	10/21/02									
sheet	revision	H	F	F	F	F	F	F	H						
index	sheet	1	2	3	4	5	6	7	8	9	10				

PDm: Rev:H STATUS: Released Printed: Jul 14, 2009

Tous droits strictement reserves. Reproduction ou communication a des tiers int  
 sous quelque forme que ce soit sans autorisation écrite du propriétaire.  
 Droits de reproduction HERO ELECTRONICS sv

All rights strictly reserved. Reproduction or issue to third parties in any for  
 whatever is not permitted without written authority from the proprietor.  
 Copyright HERO ELECTRONICS sv

Tous droits strictement réservés. Reproduction ou communication a des tiers, int  
 sous quelque forme que ce soit sans autorisation écrite du propriétaire.  
 Copyright © BERG ELECTRONICS Inc.

All rights strictly reserved. Reproduction or issue to third parties is any for  
 whatever is not permitted without written authority from the proprietor.  
 Copyright © BERG ELECTRONICS Inc.

PRODUCT NUMBER	DIM A	DIM B	DIM C	DIM D	DIM E
10017657-20110 OR 10017657-20110LF	1.4±1.0	75.6 REF	27.3 REF	4.0	66
10017657-20120 OR 10017657-20120LF	9.7±1.0	67.3 REF	19.0 REF	4.0	66
10017657-20210 OR 10017657-20210LF	1.4±1.0	75.6 REF	27.3 REF	7.0	63
10017657-20220 OR 10017657-20220LF	9.7±1.0	67.3 REF	19.0 REF	7.0	63

VIEW OF 2 ASSEMBLED CARDSHIELDS

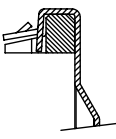
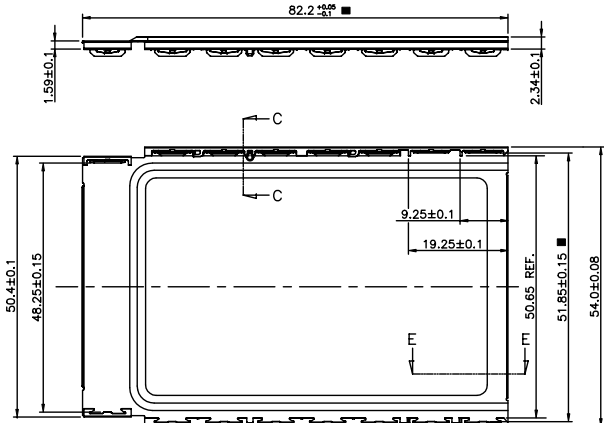
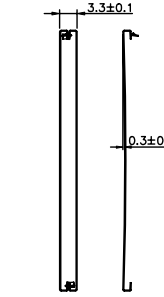

SEC. C-C (SCALE 5:1)

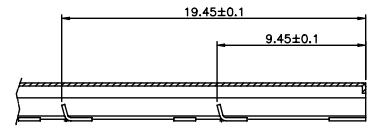

SEC. E-E (SCALE 3:1)

VIEW OF 2 ASSEMBLED CARDSHIELDS

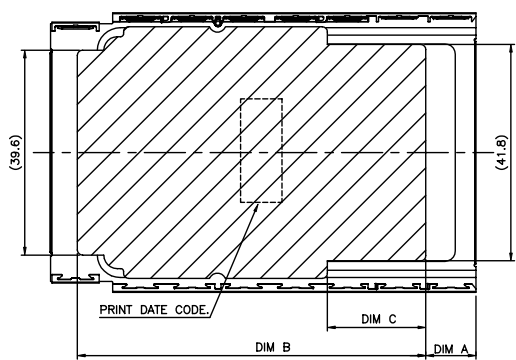
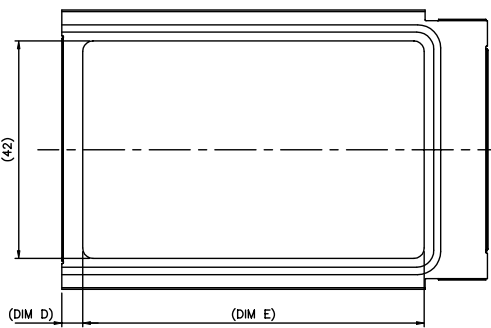
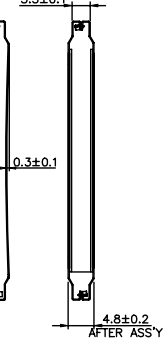

NOTE: 1. ■ : CPK MARK >= 1.5

mat'l code				tolerance unless otherwise specified		CUSTOMER	
rev.	ecn	no.	dr	date	linear	COPY	www.fciconnect.com
F					X ±0.3 X ±0.13 XX ±0.05	projection	
					angles		title
					dr	unit	product family
					enrg	mm/inch	code
					chr	scale	size
					appd	A3	dwg no.
sheet	revision						10017657
index	sheet						sheet 2 OF

Tous droits strictement réservés. Reproduction ou communication à des tiers sans autorisation écrite du propriétaire.  
 FCI ELECTRONICS Inc.

All rights strictly reserved. Reproduction or issue to third parties is any for whatever is not permitted without written authority from the proprietor.  
 FCI ELECTRONICS Inc.

PRODUCT NUMBER	DIM.A	DIM.B
10017657-20100 OR 10017657-20100LF	4.0	66
10017657-20200 OR 10017657-20200LF	7.0	63

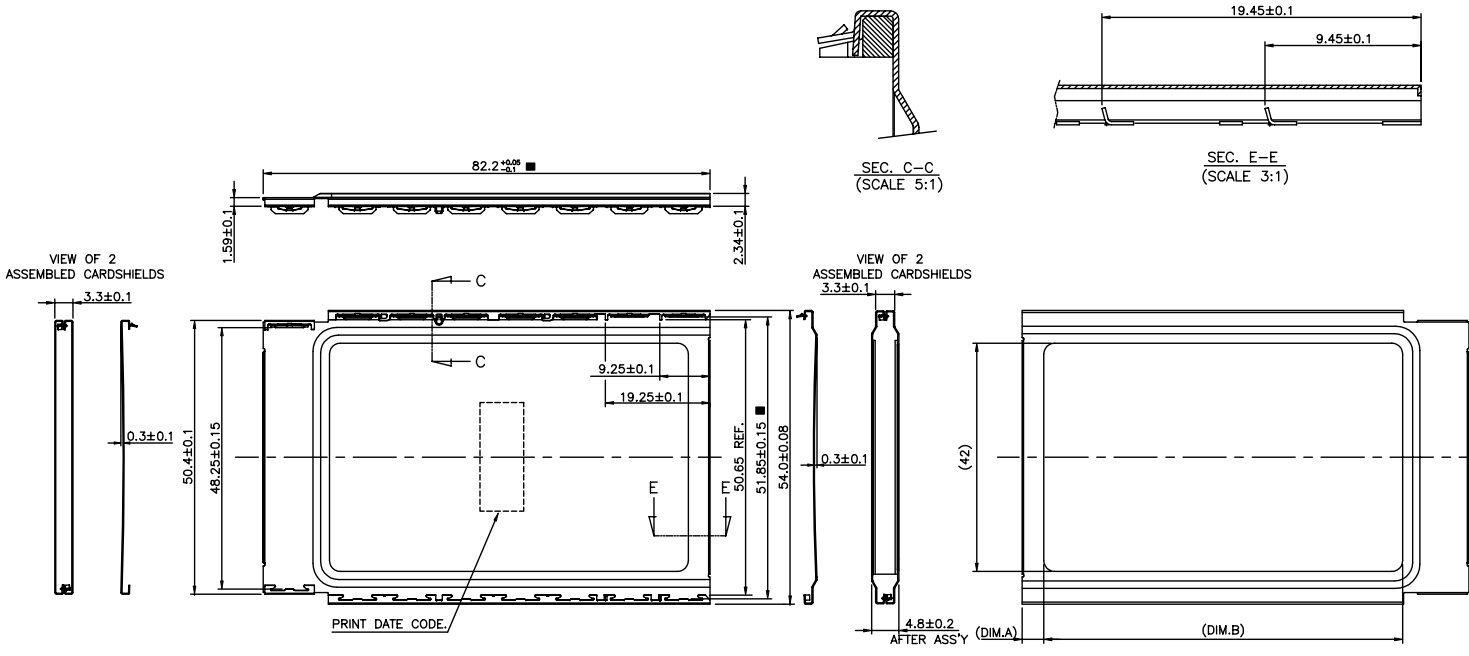

NOTE: 1. ■ : CPK MARK >= 1.5

mat'l code		tolerance unless otherwise specified		CUSTOMER COPY		FCI www.fciconnect.com	
rev.	ecn no.	dr	date	linear	X ±0.3	projection	title
F					.X ±0.13		ROCARD SHIELD
					.XX ±0.05		product family
				angles	±2°	unit	code
				dr	WENDY CHEN 10/21/02	mm/inch	
				enrg	DAVID TENG 10/21/02	scale	size
				chr	TONY CHIEN 10/21/02	A3	dwg no.
				appd	JENN TSAO 10/21/02		10017657
sheet	revision						sheet
index	sheet						3 OF

PDM: Rev:H STATUS: Released Printed: Jul 14, 2009

All rights strictly reserved. Reproduction or issue to third parties is any for whatever is not permitted without written authority from the proprietor. Copyright © BERG ELECTRONICS BV  
 Tous droits strictement réservés. Reproduction ou communication à des tiers sans autorisation écrite du propriétaire. Droits de reproduction BERG ELECTRONICS BV

PRODUCT NUMBER	DIM.A	DIM.B
10017657-20101 OR 10017657-20101LF	4.0	66
10017657-20201 OR 10017657-20201LF	7.0	63

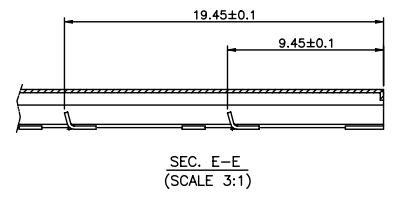
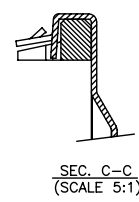

VIEW OF 2 ASSEMBLED CARDSHIELDS

VIEW OF 2 ASSEMBLED CARDSHIELDS

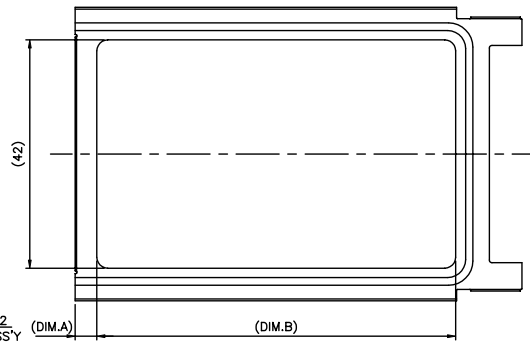
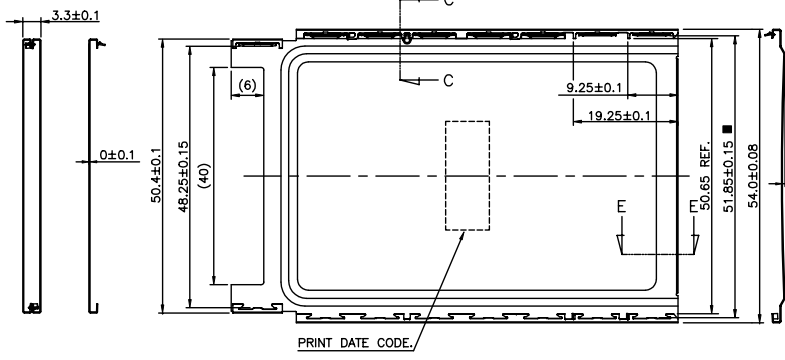

NOTE: 1. ■ : CPK MARK >= 1.5

mat'l code		tolerance unless otherwise specified		CUSTOMER	
rev.	ecn no.	dr	date	COPY	www.fciconnect.com
F				projection	title
				linear	ROCARD SHIELD
				X ±0.3	
				.X ±0.13	
				.XX ±0.05	
				angles	
				±2°	
				dr	unit
				WENDY CHEN	mm/inch
				10/21/02	product family
				engr	PCMCIA
				DAVID TENG	code
				10/21/02	size
				chr	dwg no.
				TONY CHIEN	10017657
				10/21/02	sheet
				appd	4 OF
				JENN TSAO	
sheet	revision				
index	sheet				

Tous droits strictement réservés. Reproduction ou communication a des tiers int sans aucune forme que ce soit sans autorisation écrite du propriétaire.  
 All rights strictly reserved. Reproduction or communication to third parties in any form without the prior written permission of the owner.  
 Copyright © BERG ELECTRONICS Inc.

All rights strictly reserved. Reproduction or communication to third parties in any form without the prior written permission of the owner.  
 Copyright © BERG ELECTRONICS Inc.

PRODUCT NUMBER	DIM A	DIM B	DIM C	DIM D	DIM E
10017657-20111 OR 10017657-20111LF	1.4±1.0	73.1 REF	27.3 REF	4.0	66
10017657-20121 OR 10017657-20121LF	9.7±1.0	64.8 REF	19.0 REF	4.0	66
10017657-20211 OR 10017657-20211LF	1.4±1.0	73.1 REF	27.3 REF	7.0	63
10017657-20221 OR 10017657-20221LF	9.7±1.0	64.8 REF	19.0 REF	7.0	63

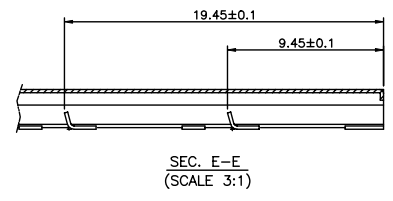
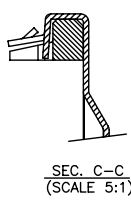

VIEW OF 2 ASSEMBLED CARDSHIELDS

VIEW OF 2 ASSEMBLED CARDSHIELDS

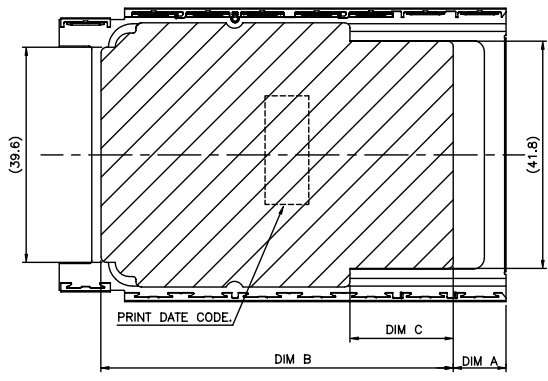
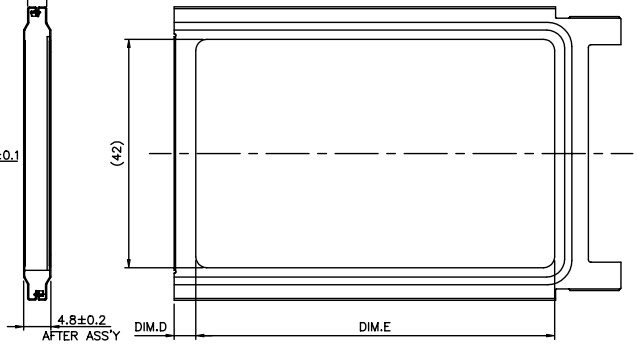
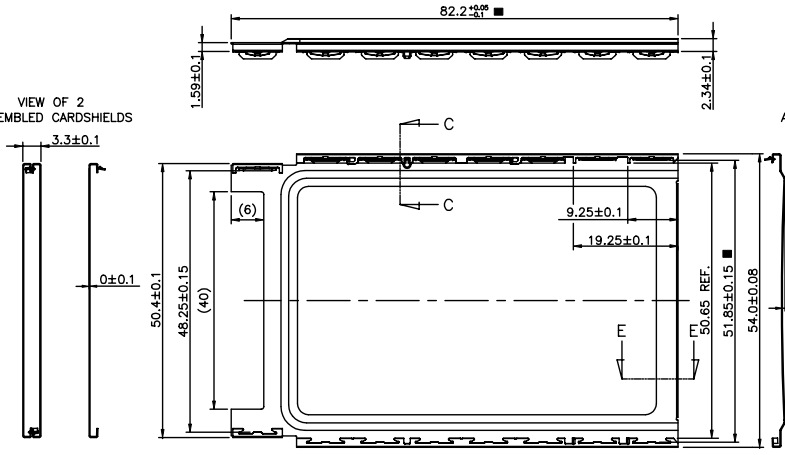

NOTE: 1. ■ : CPK MARK >= 1.5

mat'l code		tolerance unless otherwise specified		CUSTOMER		A FCI		www.fciconnect.com	
rev.	ecn no.	dr	date	linear	X ±0.3	COPY		title	
F					.X ±0.13	projection		ROCARD SHIELD	
					.XX ±0.05	A3		product family PCMCIA code	
				angles	±2°	unit		size	
				dr	WENDY CHEN 10/21/02	mm/inch		10017657	
				engr	DAVID TENG 10/21/02	scale		5 OF	
				chr	TONY CHIEN 10/21/02				
				appd	JENN TSAO 10/21/02				
sheet	revision								
index	sheet								

Tous droits strictement réservés. Reproduction ou communication, a des tiers, int sans aucune forme qui ne soit une autorisation écrite du propriétaire.  
 Droits de reproduction HERO ELECTRONICS by

All rights strictly reserved. Reproduction or issue to third parties in any form without written authority from the proprietor.  
 Copyright HERO ELECTRONICS by

1	2	3	4	5	6
PRODUCT NUMBER		CISCO P/N			
10017657-20230-C1 OR 10017657-20230-1LF		62-10960-01			
10017657-20230-C2 OR 10017657-20230-2LF		62-10962-01			

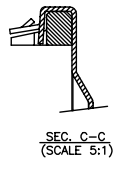
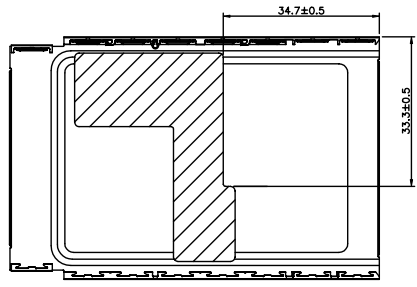
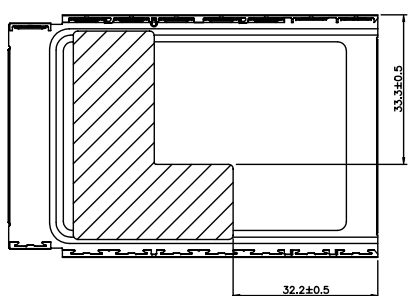
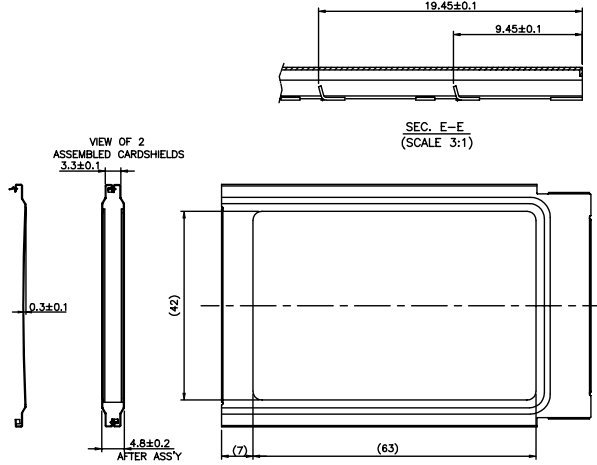
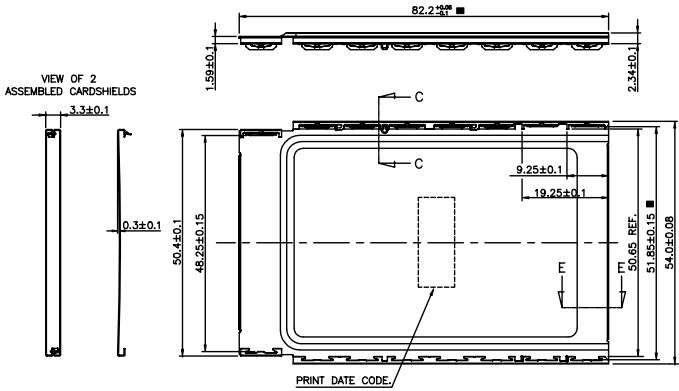

P/N: 10017657-20230-C1  
 OR  
 P/N: 10017657-20230-C1LF

P/N: 10017657-20230-C2  
 OR  
 P/N: 10017657-20230-C2LF

NOTE: 1. ■ : CPK MARK >= 1.5

mat'l code		tolerance unless otherwise specified		CUSTOMER COPY		 www.fciconnect.com	
rev.	ecn no.	dr	date	linear	X ±0.3	projection	title
F					.X ±0.13		ROCARD SHIELD CUSTOMIZED INSULATOR
				angles	.XX ±0.05		product family
				dr	±2°	unit	code
				enr		mm/inch	10017657
				chr	DAVID TENG 04/03/03	scale	6 OF
				appd	TONY CHIEN 04/03/03	A3	
					JENN TSAO 04/03/03		
sheet	revision						
index	sheet						

Tous droits strictement réservés. Reproduction ou communication à des tiers int. sans autorisation écrite du propriétaire. Copyright BERG ELECTRONICS BV

All rights strictly reserved. Reproduction or issue to third parties in any form or by any means without written authority from the proprietor. Copyright BERG ELECTRONICS BV

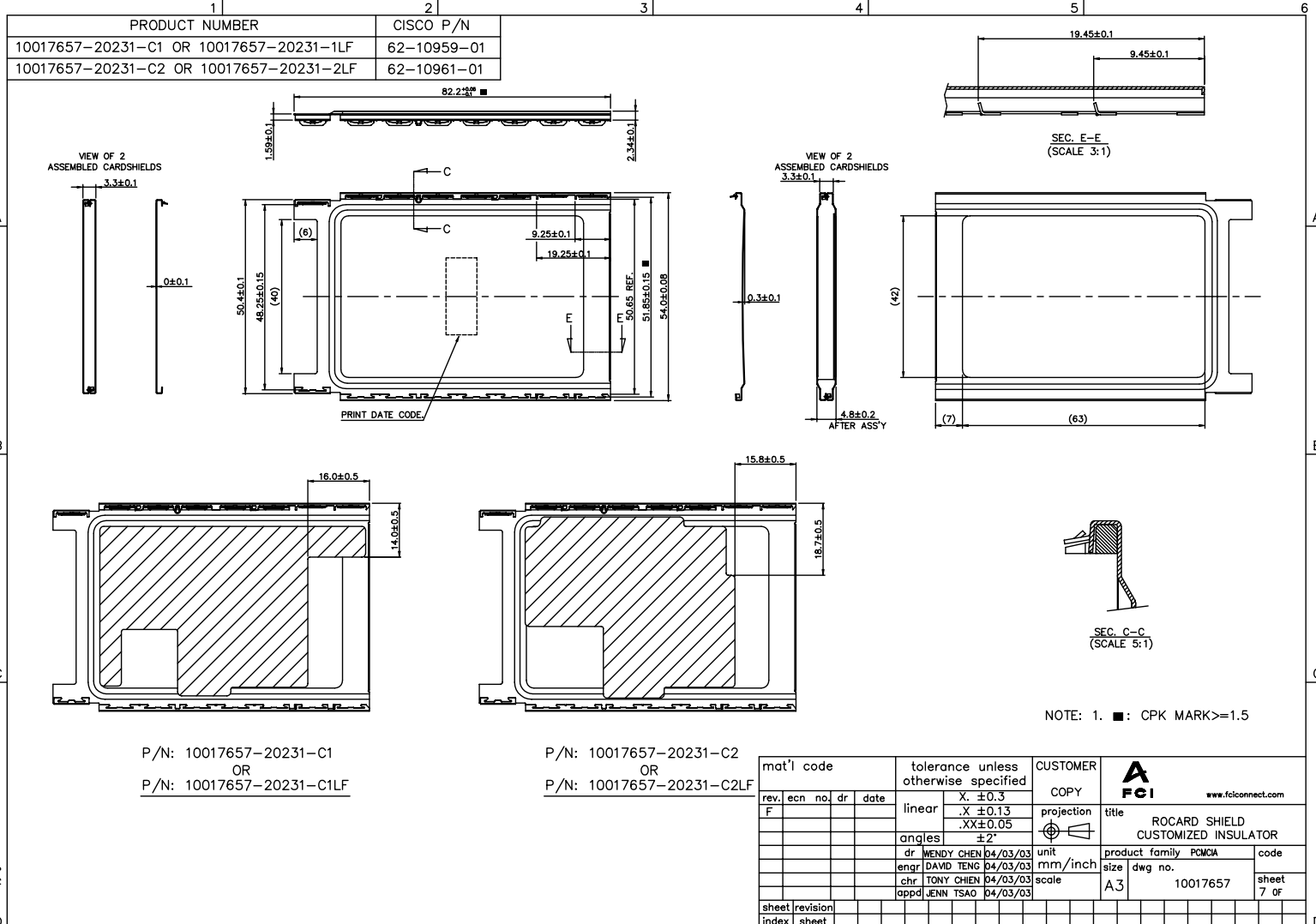

P/N: 10017657-20231-C1  
OR  
P/N: 10017657-20231-C1LF

P/N: 10017657-20231-C2  
OR  
P/N: 10017657-20231-C2LF

NOTE: 1. ■: CPK MARK>=1.5

mat'l code		tolerance unless otherwise specified		CUSTOMER		A FCI www.fciconnect.com	
rev.	ecn no.	dr	date	linear	X ±0.3 .X ±0.13 .XX ±0.05	projection	title
F				angles	±2°	⊕	ROCARD SHIELD CUSTOMIZED INSULATOR
				dr	WENDY CHEN 04/03/03	unit	product family
				enrg	DAVID TENG 04/03/03	mm/inch	PCMCIA
				chr	TONY CHIEN 04/03/03	scale	size
				appd	JENN TSAO 04/03/03	A3	dwg no.
sheet	revision						10017657
index	sheet						7 OF

PDM: Rev:H STATUS Released Printed: Jul 14, 2009

Tous droits strictement réservés. Reproduction ou communication à des tiers sans autorisation écrite du propriétaire.  
 FCI ELECTRONICS INC.

All rights strictly reserved. Reproduction or issue to third parties is any for whatever is not permitted without written authority from the proprietor.  
 FCI ELECTRONICS INC.

1	2	3	4	5	6
PRODUCT NUMBER		GEMTEK P/N			
10017657-20130-G1 OR 10017657-20130-1LF		23-600-0027			

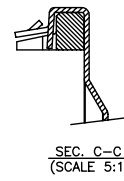
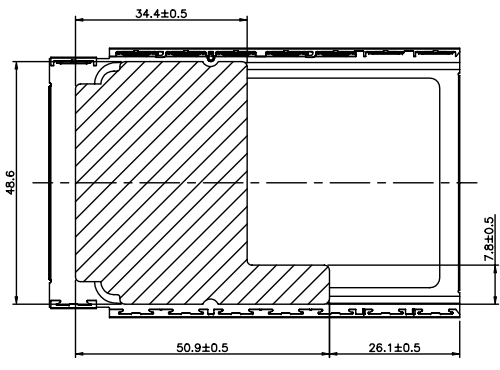
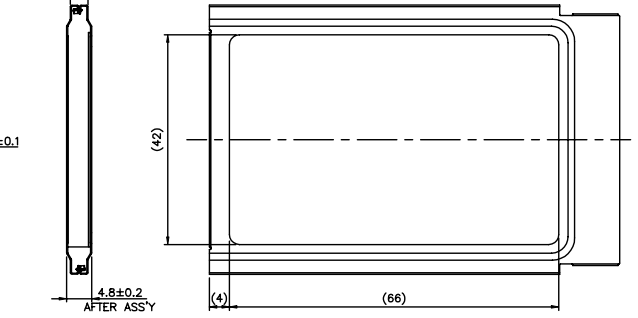
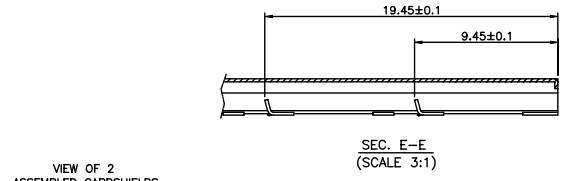
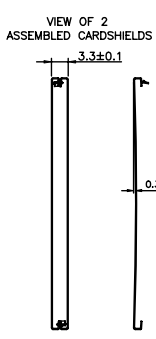
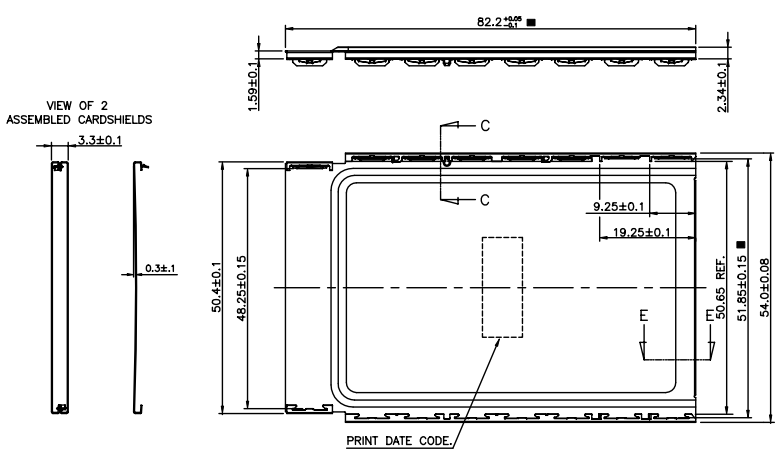

NOTE: 1. ■ : CPK MARK >= 1.5

mat'l code		tolerance unless otherwise specified		CUSTOMER COPY		FCI		www.fciconnect.com	
rev.	ecn no.	dr	date	linear	X ±0.3	projection	title	ROCARD SHIELD CUSTOMIZED INSULATOR	
F					.X ±0.13		product family	PCMCIA	
					.XX ±0.05			size	dwg no.
				angles	±2°	unit	A3	10017657	
				dr	WENDY CHEN 07/15/03	mm/inch		sheet 8 of	
				engr	DAVID TENG 07/15/03	scale			
				chr	TONY CHIEN 07/15/03				
				appd	JENN TSAO 07/15/03				
sheet	revision								
index	sheet								



Tous droits strictement réservés. Reproduction ou communication, a des tiers int  
 sous quelque forme que ce soit sans autorisation écrite du propriétaire.  
 Droits de reproduction BERG ELECTRONICS by

All rights strictly reserved. Reproduction or issue to third parties in any for  
 whatever is not permitted without written authority from the proprietor.  
 Copyright BERG ELECTRONICS by

1	2	3	4	5	6
PRODUCT NUMBER		REMARK			
10017657-20000 OR 10017657-20000LF		STANDARD TYPE (NONE OVAL-SHAPE HOLE)			
10017657-20000-01 OR 10017657-20000-1LF		FOR NOVATEL SPECIAL REQUEST (WITH OVAL-SHPAE HOLE)			

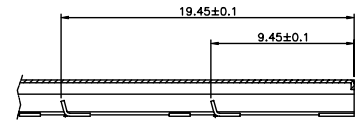

SEC. E-E  
(SCALE 3:1)

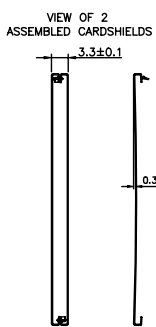

VIEW OF 2  
ASSEMBLED CARDSHIELDS

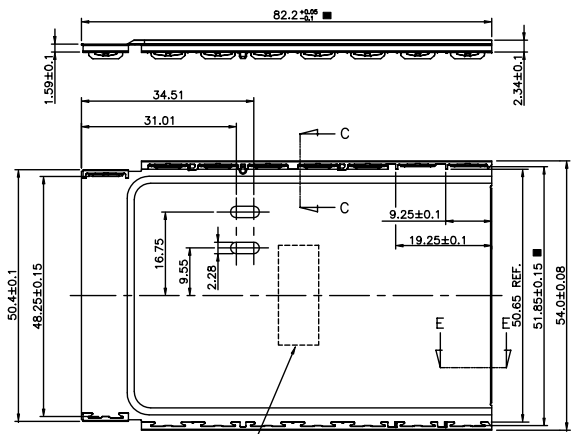

PRINT DATE CODE.

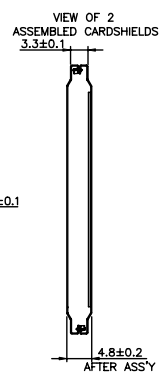

VIEW OF 2  
ASSEMBLED CARDSHIELDS  
AFTER ASSY

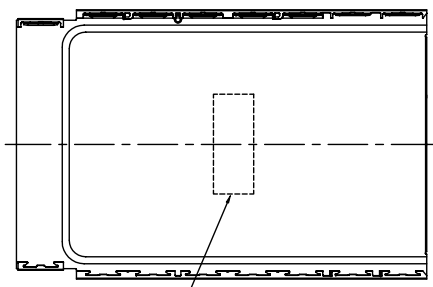
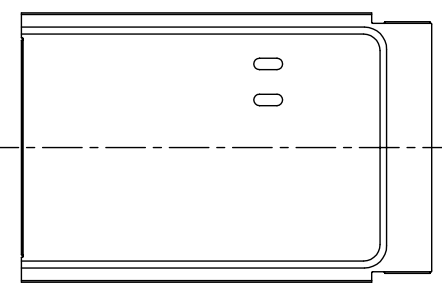

PRINT DATE CODE.

P/N: 10017657-20000 OR 10017657-20000LF

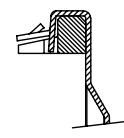

SEC. C-C  
(SCALE 5:1)

NOTE: 1. ■ : CPK MARK >= 1.5

mat'l code		tolerance unless otherwise specified		CUSTOMER COPY		FCI www.fciconnect.com	
rev.	ecn no.	dr	date	linear	X ±0.3	projection	title
F					.X ±0.13		ROCARD SHIELD
					.XX ±0.05		CUSTOMIZED REQUIREMENT
				angles	±2°		
				dr	WENDY CHEN 04/03/08	unit	product family
				enrg	DAVID TENG 04/03/08	mm/inch	PCMCIA
				chr	DAVID TENG 04/03/08	scale	size
				appd	JOSEPH HSIA 04/03/08	A3	dwg no.
sheet	revision						10017657
index	sheet						9 of

Tous droits strictement réservés. Reproduction ou communication, a des tiers int  
 sous quelque forme que ce soit sans autorisation écrite du propriétaire.  
 Droits de reproduction HERO ELECTRONICS Inc

All rights strictly reserved. Reproduction or issue to third parties is any for  
 whatever is not permitted without written authority from the proprietor.  
 Copyright HERO ELECTRONICS Inc

PRODUCT NUMBER	DIM.A	DIM.B	FRAME	INSULATOR
10017657-20201-1LF	7.0	63	YES WITH SPECIAL CUT	YES

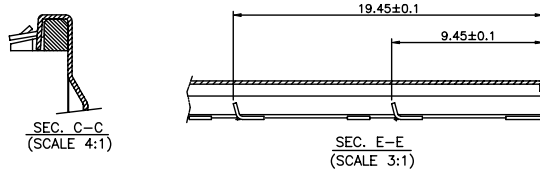
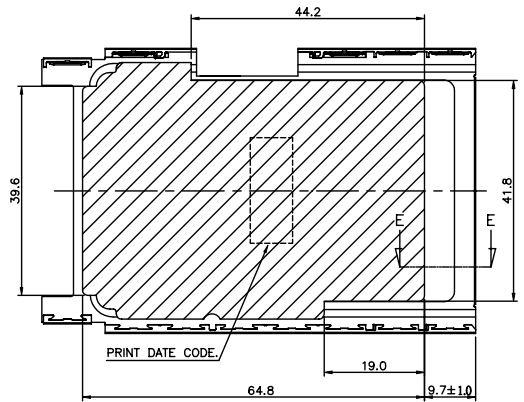
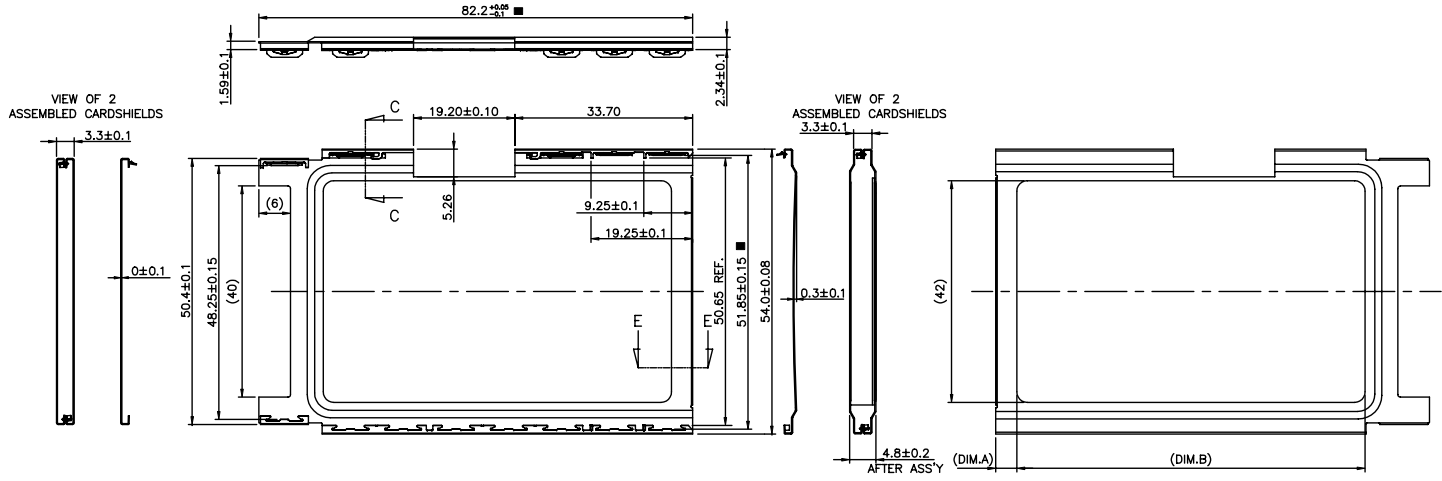

NOTE: 1. ■ : CPK MARK >= 1.5

P/N: 10017657-20201-1LF

mat'l code		tolerance unless otherwise specified		CUSTOMER COPY		 www.fciconnect.com	
rev.	ecn no.	dr	date	linear	X ±0.3	projection	title
H					.X ±0.13		ROCARD SHIELD CUSTOMIZED REQUIREMENT
					.XX ±0.05		product family
				angles	±2°	unit	code
				dr	WENDY CHEN 05/10/08	mm/inch	
				enrg	DAVID TENG 05/10/08	scale	size
				chr	DAVID TENG 05/10/08	A3	dwg no.
				appd	JOSEPH HSIAO 05/10/08		10017657
sheet	revision						sheet
index	sheet						100F

PDM: Rev:H STATUS Released Printed: Jul 14, 2009