

10 9 8 7 6 5 4 3 2 1

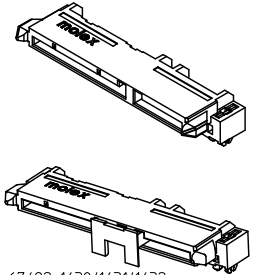

67492-1430/1431/1432  
/1325/1326/1327  
/1440/1441/1442  
/1224/1225/1226  
/1450/1451/1452.

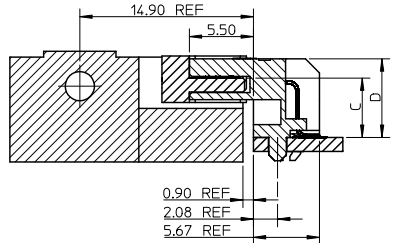
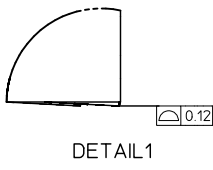
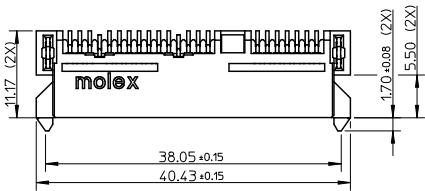
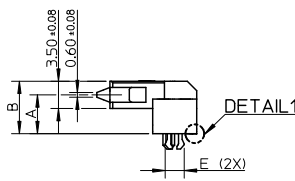
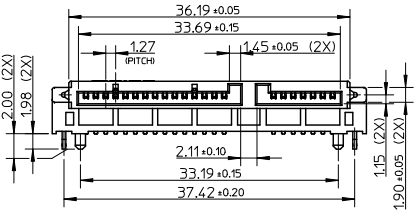

- NOTES:
- MATERIAL:
    - HOUSING: HIGH TEMPERATURE THERMAL PLASTIC, UL94V-0, COLOR: BLACK;
    - TERMINAL: COPPER ALLOY;
    - FORKLOCK: COPPER ALLOY.
  - TERMINAL PLATING:
    - CONTACT AREA:
      - (A) GOLD FLASH(0.025 MICRONS MINIMUM),
      - (B) GOLD, THICKNESS=0.76 MICRONS MINIMUM,
      - (C) GOLD, THICKNESS=0.38 MICRONS MINIMUM,
    - SOLDER AREA: MATTE TIN, THICKNESS=1.27 MICRONS MINIMUM,
    - UNDER PLATE: NICKEL, THICKNESS=1.27 MICRONS MINIMUM.
  - FORKLOCK PLATING:
    - SOLDER AREA: MATTE TIN, THICKNESS=1.27 MICRONS MINIMUM,
    - UNDER PLATE: NICKEL, THICKNESS=1.27 MICRONS MINIMUM.
  - PRODUCT SPECIFICATION: REFER TO PS-67492-001.
  - PACKAGING METHOD: TRAY, USE DRYER IN HDPE BAGE TO PREVENT BLISTER.
  - MATING PARTS: 87703/87672.
  - PRODUCT COMPLIANT TO RoSH DIRECTIVE 2002/95/EC AND ELV DIRECTIVE 2000/53/EC.

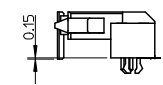
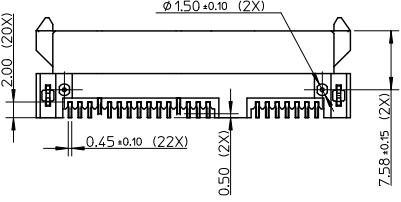

67492-1430/1431/1432  
/1325/1326/1327  
/1440/1441/1442  
/1224/1225/1226  
/1450/1451/1452.

OTHER DIMENSION PER OTHER VIEW

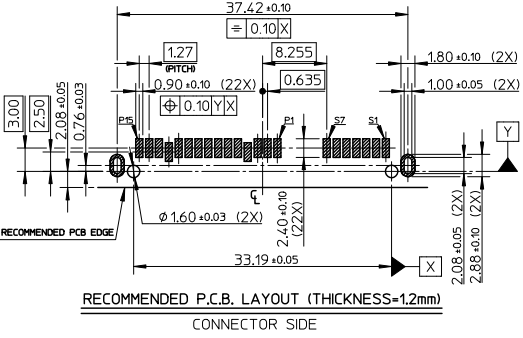

REVISED E.C. NO: SH2011-0008 2010/10/11 DRAWING: GRATE MA CHKD: 2010/10/12 APPR: RZHANG REV	QUALITY SYMBOLS ▽=0 ▽=0 ▽=0	GENERAL TOLERANCES (UNLESS SPECIFIED)		DIMENSION STYLE MM ONLY		SCALE 1:1	DESIGN UNITS METRIC	THIRD ANGLE PROJECTION	
		4 PLACES ± --- ± ---	mm INCH	DRAWN BY GRATE MA	DATE 2003/10/10	TITLE SATA HOST RECEPTACLE R/A SMT TYPE			
		3 PLACES ± --- ± ---		CHECKED BY YA JUN	DATE 2003/10/10	MOLEX INCORPORATED			
		2 PLACES ± 0.15 ± --- 1 PLACE ± 0.25 ± --- ANGULAR ± 3°		APPROVED BY SAM	DATE 2003/10/10	MATERIAL NO. SEE SHEET 2	DOCUMENT NO. SD-67492-001	SHEET NO. 1 OF 2	
DRAFT WHERE APPLICABLE MUST REMAIN WITHIN DIMENSIONS		THIS DRAWING CONTAINS INFORMATION THAT IS PROPRIETARY TO MOLEX INCORPORATED AND SHOULD NOT BE USED WITHOUT WRITTEN PERMISSION							

10 9 8 7 6 5 4 3 2 1

P/N	PLATING	DIM'A'	DIM'B'	DIM'C'	DIM'D'	DIM'E'	REMARK
67492-1420	NOTES 2 (A)						TRAY PACKAGE PK-67492-001
67492-1421	NOTES 2 (B)	4.15	5.90	4.25	5.90	2.45±0.10	
67492-1422	NOTES 2 (C)						
67492-1320	NOTES 2 (A)						
67492-1321	NOTES 2 (B)	3.50	5.25	3.60	5.25	2.45±0.10	
67492-1322	NOTES 2 (C)						
67492-1120	NOTES 2 (A)						
67492-1121	NOTES 2 (B)	1.80	3.55	1.90	3.55	2.45±0.10	
67492-1122	NOTES 2 (C)						
67492-9220	NOTES 2 (A)						
67492-9221	NOTES 2 (B)	4.99	6.74	5.09	6.74	2.45±0.10	
67492-9222	NOTES 2 (C)						
67492-1220	NOTES 2 (A)						TAPE&REEL PACKAGE PK-67492-002
67492-1221	NOTES 2 (B)	4.99	6.74	5.09	6.74	2.45±0.10	
67492-1222	NOTES 2 (C)						
67492-1224	NOTES 2 (A)						TAPE&REEL PACKAGE WITH CAP PK-67492-002
67492-1225	NOTES 2 (B)	4.99	6.74	5.09	6.74	2.33±0.05	
67492-1226	NOTES 2 (C)						
67492-1430	NOTES 2 (A)						TAPE&REEL PACKAGE WITH CAP PK-67492-008
67492-1431	NOTES 2 (B)	4.15	5.90	4.25	5.90	2.45±0.10	
67492-1432	NOTES 2 (C)						
67492-1325	NOTES 2 (A)						
67492-1326	NOTES 2 (B)	3.50	5.25	3.60	5.25	2.45±0.10	
67492-1327	NOTES 2 (C)						
67492-1440	NOTES 2 (B)						
67492-1441	NOTES 2 (A)	4.15	5.90	4.25	5.90	2.33±0.05	
67492-1442	NOTES 2 (C)						
67492-1450	NOTES 2 (A)						
67492-1451	NOTES 2 (B)	4.10	5.85	4.20	5.85	2.33±0.05	
67492-1452	NOTES 2 (C)						

REVISED EC NO: SH2011-0008 M 2010/10/11 DRW:GILLI CHKD: APPR:RZHANG 2010/10/12 REV	QUALITY SYMBOLS =0 =0 =0	GENERAL TOLERANCES (UNLESS SPECIFIED)		DIMENSION STYLE MM ONLY		SCALE 1:1	DESIGN UNITS METRIC	THIRD ANGLE PROJECTION	
		4 PLACES ± --- ± --- 3 PLACES ± --- ± --- 2 PLACES ± 0.15 ± --- 1 PLACE ± 0.25 ± ---	mm INCH ± --- ± --- ± 0.15 ± --- ± 0.25 ± ---	DRAWN BY GRATE MA	DATE 2003/10/10	TITLE SATA HOST RECEPTACLE R/A SMT TYPE			
		DRAFT WHERE APPLICABLE MUST REMAIN WITHIN DIMENSIONS		CHECKED BY YA JUN	DATE 2003/10/10	MOLEX INCORPORATED			
				APPROVED BY SAM	DATE 2003/10/10	MATERIAL NO. SEE TABLE	DOCUMENT NO. SD-67492-001	SHEET NO. 2 OF 2	

tb\_frame\_A3\_P\_AM\_T  
Rev. F 2009/06/18

9 8 7 6 5 4 3 2 1