

4

3

2

1

THIS DRAWING IS UNPUBLISHED. RELEASED FOR PUBLICATION SEP. 2004. COPYRIGHT © 2004 BY TE CONNECTIVITY. ALL RIGHTS RESERVED.

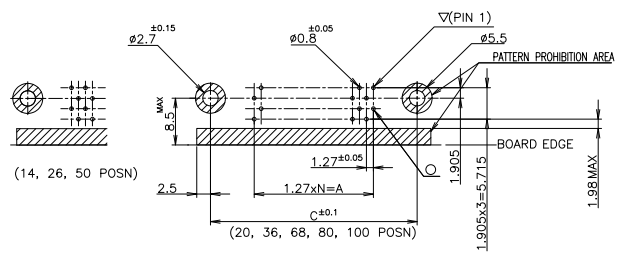
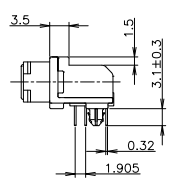
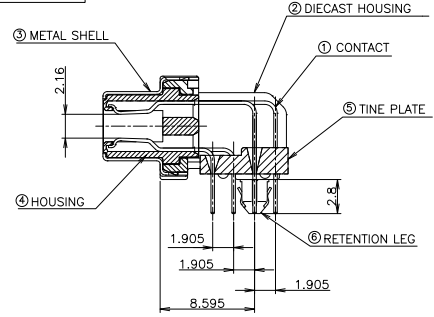
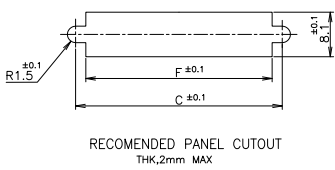
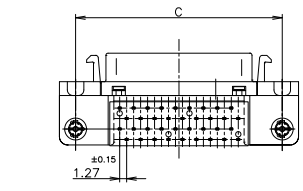
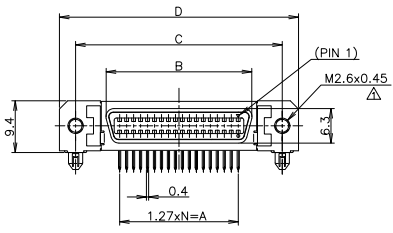
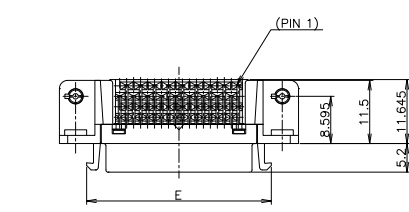

RECOMMENDED PC BOARD MOUNTING DIMENSION (COMPONENT SIDE)

LEAD FREE

LOC		DIST		REVISIONS		
J	F	LNK	REVISED PER ECO-11-005033	DATE	BY	APP'D
	A1			25MAR11	RK	HMR
ITEM	MATERIAL	FINISH				
①	COPPER ALLOY	NICKEL UNDER PLATE ALL OVER CONTACT AREA ; Au(0.3u, 0.76u) SOLDER TINE AREA ; TIN PLATE				
②	ZINC	NICKEL PLATING				
③	STEEL 10.25	NICKEL PLATE OVER COPPER UNDERPLATE				
④	THERMO-PLASTIC(UL-94V-0)	COLOR ; BLACK				
⑤						
⑥	COPPER ALLOY	TIN PLATE OVER NICKEL UNDERPLATE				

- NOTES:
- △ RECOMMENDED SCREW SIZE ; M2.6 PANHEAD SCREW(L=5)
 - 2. RECOMMENDED P.C BOARD THICKNESS ; 1.6mm (REF)
 - 3. CONNECTOR TO BE MATED;175677
 - 4. INSERTION FORCE OF RETENTION LEG TO P.C.B; 21.56N(2.2kgf) MAX/CONNECTOR.
 - 5. RETENTIVITY OF RETENTION LEG TO P.C.B; 4.9N(0.5kgf) MIN/CONNECTOR.

39	61.9	61.55	71.45	65.55	54.53	49.53	0.76um	80	3-5178238-0
49	74.6	74.25	84.15	78.25	67.23	62.23	0.76um	100	2-5178238-9
33	54.2	53.93	63.83	57.93	46.91	41.91	0.76um	68	2-5178238-8
24	42.8	42.50	52.40	46.50	35.48	30.48	0.76um	50	2-5178238-7
17	33.9	33.61	43.51	37.61	26.59	21.59	0.76um	36	2-5178238-5
12	27.6	27.26	37.16	31.26	20.24	15.24	0.76um	26	2-5178238-4
9	23.8	23.45	33.35	27.45	16.43	11.43	0.76um	20	2-5178238-2
6	19.9	19.64	29.54	23.64	12.62	7.62	0.76um	14	2-5178238-1
39	61.9	61.55	71.45	65.55	54.53	49.53	0.3 um	80	1-5178238-0
49	74.6	74.25	84.15	78.25	67.23	62.23	0.3 um	100	5178238-9
33	54.2	53.93	63.83	57.93	46.91	41.91	0.3 um	68	5178238-8
24	42.8	42.50	52.40	46.50	35.48	30.48	0.3 um	50	5178238-7
17	33.9	33.61	43.51	37.61	26.59	21.59	0.3 um	36	5178238-5
12	27.6	27.26	37.16	31.26	20.24	15.24	0.3 um	26	5178238-4
9	23.8	23.45	33.35	27.45	16.43	11.43	0.3 um	20	5178238-2
6	19.9	19.64	29.54	23.64	12.62	7.62	0.3 um	14	5178238-1
N	F	E	D	C	B	A	Au PLT, POSITION		PART NO.

THIS DRAWING IS A CONTROLLED DOCUMENT. DATE: 1306004

DRN: T.KAWAMAE 1306004
CHK: 1306004
APP: T. ENOMOTO 1306004
PRODUCT SPEC: 108-5288
APPLICATION SPEC: A2 00779 C=5178238

MATERIAL: SEE TABLE
FINISH: SEE TABLE

RECEPTACLE HDR ASSY (3.1mm)
RETENTION LEG TYPE
STANDARD CHAMP.050 SERIES (II)

SCALE: 2:1 SHEET: 1 of 1 REV: A1