

REFERENCE SPECIFICATIONS

-NFC 93425 (in compliance with HE 507)

PHYSICAL CHARACTERISTICS

-INSULATOR MATERIAL: THERMOPLASTIC UL94V0
 -CONTACT MATERIAL: PHOSPHOR BRONZE

-ACCESSORIES: BRASS
 -SHELLS: STEEL

ELECTRICAL CHARACTERISTICS

-NOMINAL CURRENT: 7.5A
 -CONTACT RESISTANCE: <= 7.3 m ohms
 -CONTACT/CONTACT : >=1000 V
 -CONTACT/GROUND : >=1200 V
 -INSULATION RESISTANCE: >=5000 MOhms

ENVIRONMENTAL CHARACTERISTICS

- CLIMATIC CATEGORY: 55/125/21
 TEMPERATURE RANGE -55°C TO +125°C
 DAMP HEAT STEADY STATE 21 DAYS
 SALT SPRAY 48 HOURS

MECHANICAL CHARACTERISTICS

- RETENTION AGAINST TORQUE: - Threaded insert: 0.7 N.m minimum
 - Female screw : 0.5 N.m minimum

NOTE RoHS INFORMATION

- The "LF" products meet european union Directives and other country regulations as described in GS-22-008.
- Termination plating spec:
 Ni + Gold
- Active area plating spec:
 Ni + Gold
- Shell plating : 2 to 4µm Cu + Nickel + 3 to 10µm Sn.pure bright
- Accessories: Sn pure bright + nickel
- Packaging spec: See GS-14-920

DBL13W3S043A00LF

Series

Shell size: **E A B C D**
 see sheet 2

Front accessory definition
 see sheet 2

- Blank** :without accessory
- L** :threaded insert M3
- O** :threaded insert UNC 4-40

Layout of contacts (see sheet 3)

Contacts

- S** :Socket

Plating

- Blank** signal solder bucket 200 matings/unmatings
- 043** signal solder bucket 500 matings/unmatings

PCB accessory definition

- A** without accessory on PCB

Power contacts

- 00** without power contact

See note RoHS

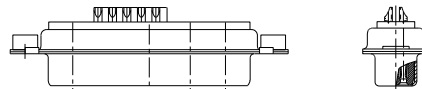

13W3 FOR EXAMPLE

www.fciconnect.com		surface	tolerance std	projection	mm
		150 1302	150 106 150 1101	⊕	
TOLERANCES UNLESS OTHERWISE SPECIFIED					
Dr	M PESSON	2005-10-11	ANGULAR	0.X	00.3
Eng	P LEGARE	2005-10-11	LINEAR	0.XX	00.1
Chr				0.XXX	00.05
Product family			- Spec.ref		
Rev.	ecn no	dr	date		
A	3305-0101	MPE	2005-10-11		
B	3308-0208	LSO	2006-12-12		
C	3307-0273	MPE	2007/10/31		
D	F10-0013	LSA	2010/07/20		
FCI		SUB FEMALE DW		0	Rev.
catalog no		mixed power+solder bucket		001-8639-2303	D
				CUSTOMER	sheet 1 of 7

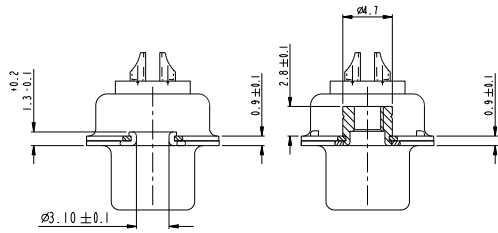

FRONT ACCESSORY	Blank	without	L	insert M3
			O	insert UNC 4.40
PCB ACCESSORIES	A	without	A	without

PART NUMBER	MATINGS/ UNMATINGS	FRONT ACCESSORY	PCB ACCESSORIES
D*xWxSA00LF	200	without	without
D*LxWxSA00LF	200	insert M3	without
D*OxWxSA00LF	200	insert UNC 4.40	without
D*xWxS043A00LF	500	without	without
D*LxWxS043A00LF	500	insert M3	without
D*OxWxS043A00LF	500	insert UNC 4.40	without

shell size	LAYOUTS
*	xWx
E	5W1
A	11W1
A	7W2
B	21W1
B	17W2
B	13W3
B	9W4
C	25W3
C	21WA4
C	27W2
D	47W1
D	24W7
D	36W4

Copyright FCJ

www.fcjconnect.com		surface <input checked="" type="checkbox"/> ISO 1302	tolerance std <input checked="" type="checkbox"/> ISO 1302	projection <input checked="" type="checkbox"/> ASME Y14.5	mm
TOLERANCES UNLESS OTHERWISE SPECIFIED					
Dr	M PESSON	2005-10-11	ANGULAR	0.1	0.1
Eng	P LEGARE	2005-10-11	LINEAR	0.1x	0.1
Chr				0.1x	0.05
Appr			Product family		Spec ref
FCJ		SUB FEMALE DW		0	Rev.
colalog no		mixed power+solder bucket		001-8639-2303	D
		CUSTOMER		sheet 2 of 7	

SCALE: 4

5W1

11W1

7W2

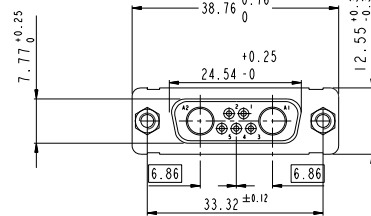
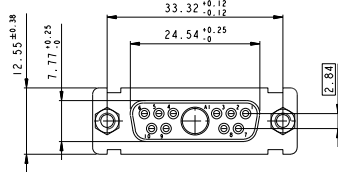
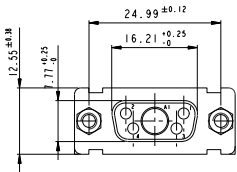

SIDE VIEW FOR LAYOUTS: E A B C

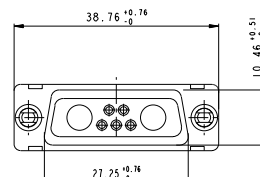
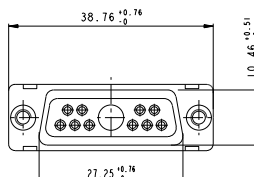
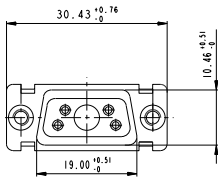
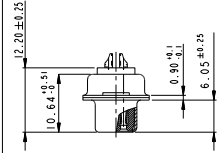
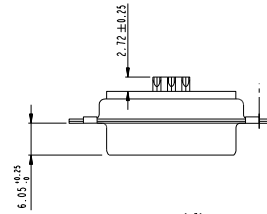
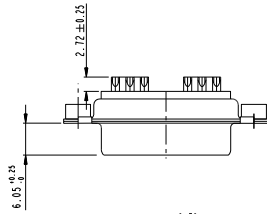
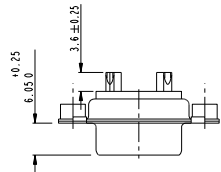

Floating signal contacts

Copyright FCI

www.fciconnect.com		Surface 150 1302	Tolerance std 150 106 150 110	projection	mm
TOLERANCES UNLESS OTHERWISE SPECIFIED		ANGULAR	LINEAR	2:1	Scale
Dr M PESSON 2005-10-11	Eng P LEGARE 2005-10-11	0.1	0.1	A2	2:1
Chr		0.1XX	0.05	ECN	LS07-0273
Appr		Product family		Spec ref	
FCI SUB FEMALE DW mixed power solder bucket		Rev. no	C01-8639-2303	Rev.	D
colalog no		CUSTOMER		sheet 3 of 7	

13W3

9W4

17W2

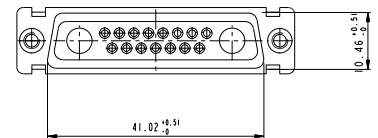
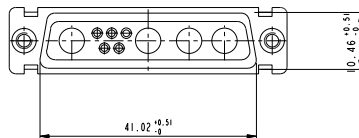
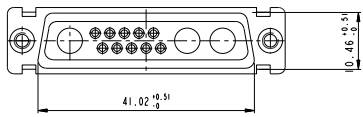
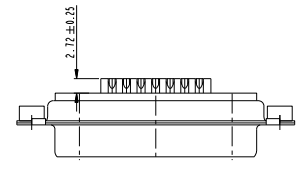
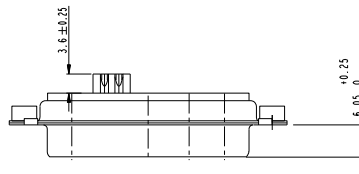
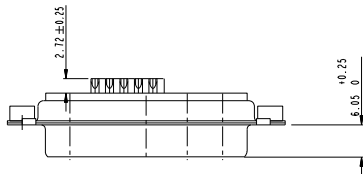
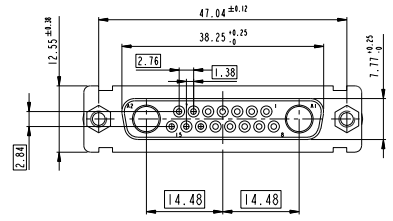
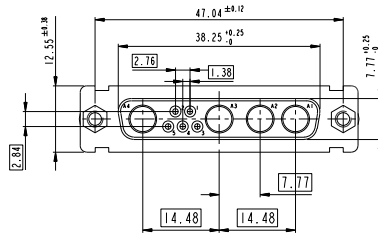
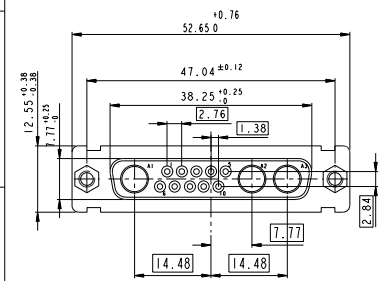

Floating signal contacts

Copyright FCi

www.fciconnect.com		Surface 150 1302	Tolerance std 150 106 150 1101	projection	mm
TOLERANCES UNLESS OTHERWISE SPECIFIED		0.1	0.1	1:1x	Scale
Dr M PESSON 2005-10-11	ANGULAR	0.1x	0.1	A2	2:1
Eng P LEGARE 2005-10-11	LINEAR	0.1x	0.05	ECN	LS07-0273
Chr	Product family	- Spec ref			
Appr	Product family	- Spec ref			
FCi	SUB FEMALE DW	0.0	0.0	C01-8639-2303	Rev. D
	Mixed power+solder bucket	CUSTOMER		sheet 4 of 7	

21W1

27W2

21WA4

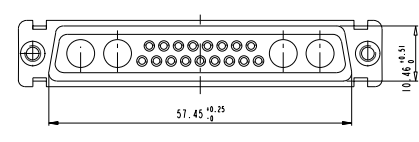
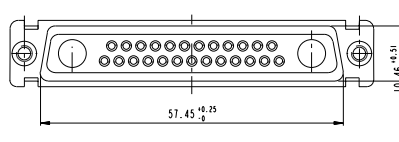
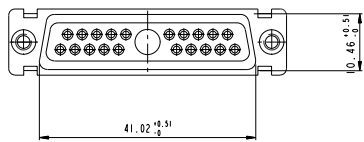
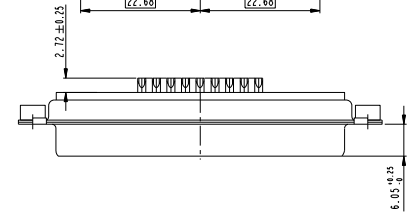
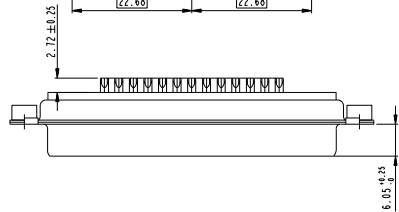
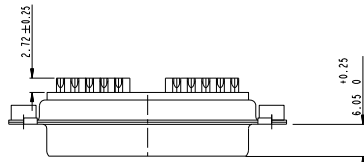
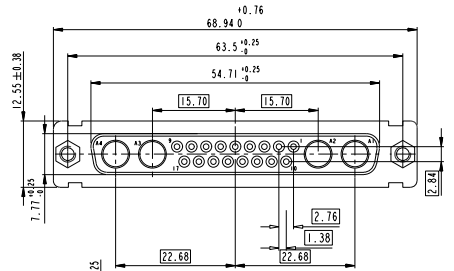
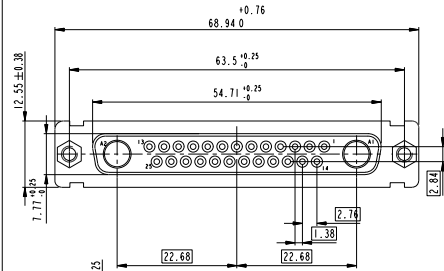
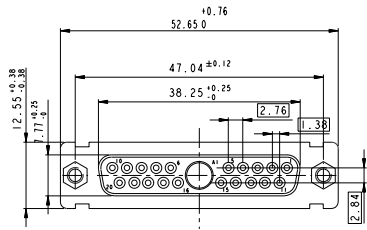

Copyright FCI

www.fciconnect.com		surface	ISO 1302	tolerance std	ISO 1006 ISO 1101	projection	mm
		TOLERANCES UNLESS OTHERWISE SPECIFIED					
Dr	M PESSON	2005-10-11	ANGULAR	0.1	±0.1	1:xx	Scale
Eng	P LEGARE	2005-10-11	LINEAR	0.xx	±0.1	A2	2:1
Chr			0°	±0°	±0.05	ECN	LS07-0273
Appr			Product family	- Spec ref			
FCI		SUB FEMALE DW		C01-8639-2303		Rev.	
		mixed power+solder bucket		CUSTOMER		sheet 5 of 7	

25W3

24W7

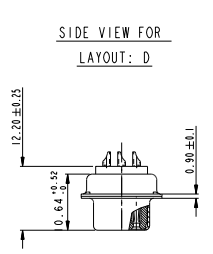
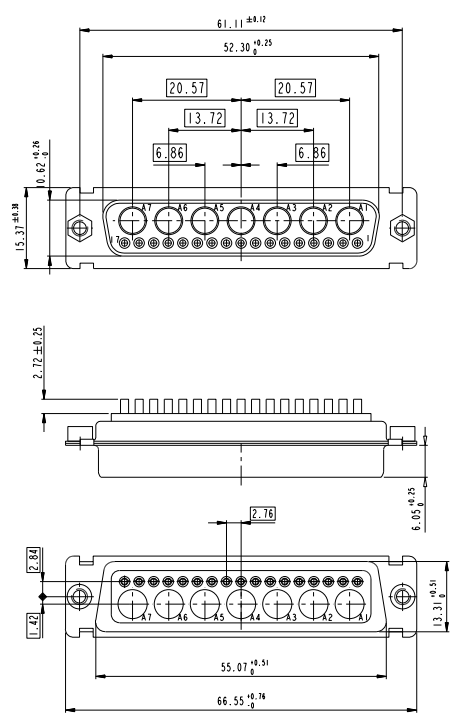
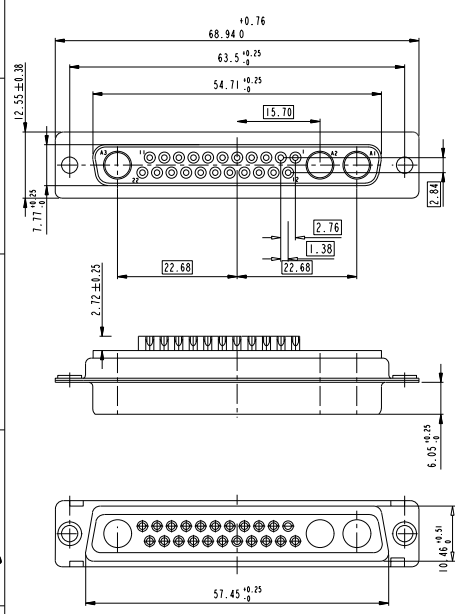

Copyright FCI

www.fciconnect.com		surface 150 1502	tolerance std 150 106 150 1101	projection	mm
Dr M PESSON 2005-10-11		TOLERANCES UNLESS OTHERWISE SPECIFIED		1:1	Scale
Eng P LEGARE 2005-10-11	ANGULAR	LINEAR	0.1 0.1	A2	2:1
Chr	0° ± 0°	0.1xx ± 0.05	ECN	LS07-0273	
Appr	Product family		- Spec ref		
FCI	SUB FEMALE DW	0	C01-8639-2303	Rev.	D
	mixed power+solder bucket				
colalog no	CUSTOMER		sheet 6 of 7		

36W4

47W1

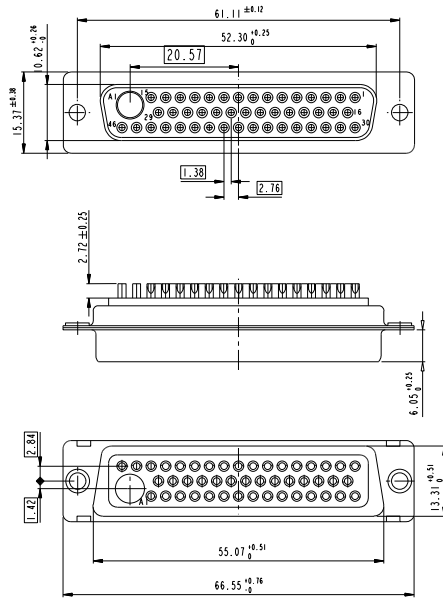
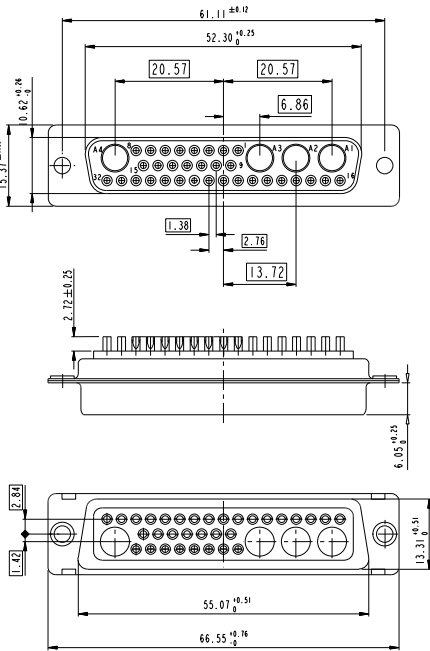

Copyright FCI

www.fciconnect.com		surface	tolerance std	projection	mm
		ISO 1302	ISO 1101	ASME Y14.5	
TOLERANCES UNLESS OTHERWISE SPECIFIED					
Dr M PESSON	2005-10-11	ANGULAR	0.1	0.1	Scale
Eng P LEGARE	2005-10-11	LINEAR	0.1x	0.1	2:1
Chr		0° ±0°	0.1x	0.05	ECN
		Product family	- Spec ref		
FCI		SUB FEMALE DW	0	0	Rev.
colalog no		mixed power+solder bucket	C01-8639-2303		D
		CUSTOMER	sheet 7 of 7		