

SAC-3P-Y/2XFS B PE SCO

Order No.: 1523968

<http://eshop.phoenixcontact.de/phoenix/treeViewClick.do?UID=1523968>Y-distributor, 3-pos. +PE, straight connector M12 SPEEDCON on 2 x
straight socket M12 SPEEDCON, PIN 2+4, bridged

Commercial data	
GTIN (EAN)	 4 046356 072960
sales group	D116
Pack	5 pcs.
Customs tariff	85366990
Catalog page information	Page 160 (PC-2011)

Product notes

WEEE/RoHS-compliant since:
07/01/2005



<http://www.download.phoenixcontact.com>
Please note that the data given here has been taken from the online catalog. For comprehensive information and data, please refer to the user documentation. The General Terms and Conditions of Use apply to Internet downloads.

Technical data	
General data	
Rated current at 40°C	4 A
Rated voltage	60 V
Number of positions	3
Volume resistance	≤ 5 mΩ

Insulation resistance	≥ 10 GΩ
Ambient temperature (operation)	-25 °C ... 90 °C

General characteristics

Standards/regulations	M12 connector IEC 61076-2-101
Coding	A - standard
Center distance	18 mm
Surge voltage category	II
Pollution degree	3
Degree of protection	IP65/IP68/IP69K
Insertion/withdrawal cycles	≥ 100
Torque	0.4 Nm
Contact material	CuZn
Contact surface material	Ni/Au
Contact carrier material	TPU GF
Material of grip body	TPU, hardly inflammable, self-extinguishing
Material, knurls	Zinc die-cast, nickel-plated
Sealing material	NBR
Status display	No

Accessories

Item	Designation	Description
Protection and sealing elements		
1560251	PROT-M12 FS	M12 sealing cap for unoccupied M12 connectors of the sensor/ actuator cable, flush-type connectors and I/O devices in the field
1553129	PROT-MS SCO	M12 screw plug with SPEEDCON quick locking for unoccupied M12 sockets of the sensor/actuator cables, boxes and flush-type connectors

Tools

1208432	SAC BIT M12-D15	Nut for assembling sensor/actuator cables with M12 connector and for M12 connectors with QUICKON fast connection technology, for 4 mm hexagonal drive
1208429	TSD 04 SAC	Torque screwdriver, with preset torque of 0.4 Nm and 4 mm hexagonal drive for M12 connectors

Diagrams/Drawings

Dimensioned drawing

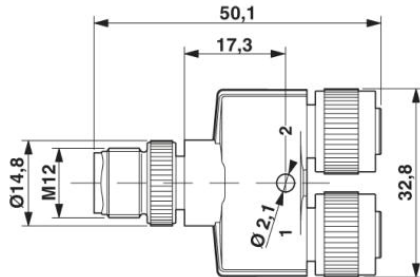

Plug M12 x 1, Y distributor

Circuit diagram

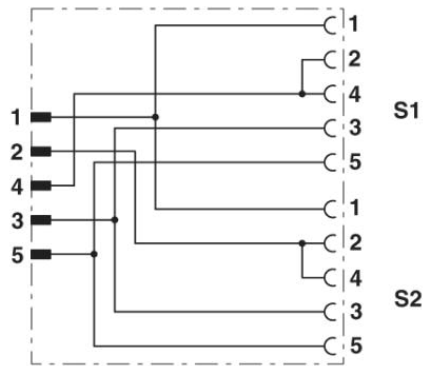

Contact assignment of the M12 Y-distributor

Schematic diagram

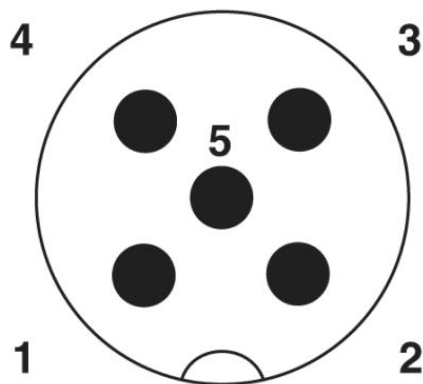

Pin assignment M12 male connector, 5-pos., A-coded, male side

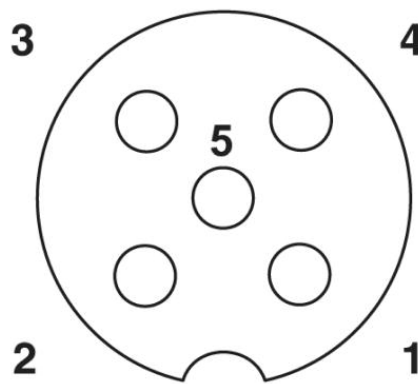

Pin assignment M12 socket, 5-pos., A-coded, socket side view

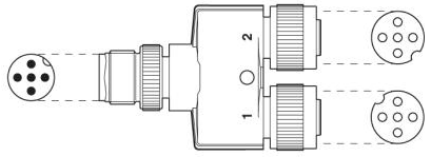

Layout of connector pin assignments

Address

PHOENIX CONTACT Inc., USA
586 Fulling Mill Road
Middletown, PA 17057, USA
Phone (800) 888-7388
Fax (717) 944-1625
<http://www.phoenixcon.com>



© 2011 Phoenix Contact
Technical modifications reserved;