

# MC14049B, MC14050B

## Hex Buffer

The MC14049B Hex Inverter/Buffer and MC14050B Noninverting Hex Buffer are constructed with MOS P-Channel and N-Channel enhancement mode devices in a single monolithic structure. These complementary MOS devices find primary use where low power dissipation and/or high noise immunity is desired. These devices provide logic level conversion using only one supply voltage,  $V_{DD}$ .

The input-signal high level ( $V_{IH}$ ) can exceed the  $V_{DD}$  supply voltage for logic level conversions. Two TTL/DTL loads can be driven when the devices are used as a CMOS-to-TTL/DTL converter ( $V_{DD} = 5.0\text{ V}$ ,  $V_{OL} \leq 0.4\text{ V}$ ,  $I_{OL} \geq 3.2\text{ mA}$ ).

Note that pins 13 and 16 are not connected internally on these devices; consequently connections to these terminals will not affect circuit operation.

### Features

- High Source and Sink Currents
- High-to-Low Level Converter
- Supply Voltage Range = 3.0 V to 18 V
- $V_{IN}$  can exceed  $V_{DD}$
- Meets JEDEC B Specifications
- Improved ESD Protection On All Inputs
- Pb-Free Packages are Available\*

### MAXIMUM RATINGS (Voltages Referenced to $V_{SS}$ )

Symbol	Parameter	Value	Unit
$V_{DD}$	DC Supply Voltage Range	-0.5 to +18.0	V
$V_{in}$	Input Voltage Range (DC or Transient)	-0.5 to +18.0	V
$V_{out}$	Output Voltage Range (DC or Transient)	-0.5 to $V_{DD} + 0.5$	V
$I_{in}$	Input Current (DC or Transient) per Pin	$\pm 10$	mA
$I_{out}$	Output Current (DC or Transient) per Pin	$\pm 45$	mA
$P_D$	Power Dissipation, per Package (Note 1) (Plastic) (SOIC)	825 740	mW
$T_A$	Ambient Temperature Range	-55 to +125	$^{\circ}\text{C}$
$T_{stg}$	Storage Temperature Range	-65 to +150	$^{\circ}\text{C}$
$T_L$	Lead Temperature (8-Second Soldering)	260	$^{\circ}\text{C}$

1. Temperature Derating: See Figure 3.

This device contains protection circuitry to protect the inputs against damage due to high static voltages or electric fields referenced to the  $V_{SS}$  pin only. Extra precautions must be taken to avoid applications of any voltage higher than the maximum rated voltages to this high-impedance circuit. For proper operation, the ranges  $V_{SS} \leq V_{in} \leq 18\text{ V}$  and  $V_{SS} \leq V_{out} \leq V_{DD}$  are recommended.

Unused inputs must always be tied to an appropriate logic voltage level (e.g., either  $V_{SS}$  or  $V_{DD}$ ). Unused outputs must be left open.

\*For additional information on our Pb-Free strategy and soldering details, please download the ON Semiconductor Soldering and Mounting Techniques Reference Manual, SOLDERRM/D.



ON Semiconductor®

### MARKING DIAGRAMS

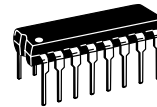

PDIP-16  
P SUFFIX  
CASE 648

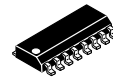

SOIC-16  
D SUFFIX  
CASE 751B

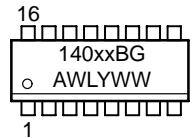

TSSOP-16  
DT SUFFIX  
CASE 948F

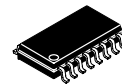
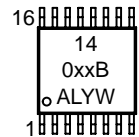

SOEIAJ-16  
F SUFFIX  
CASE 966

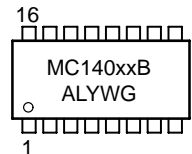

xx = Specific Device Code  
A = Assembly Location  
WL, L = Wafer Lot  
YY, Y = Year  
WW, W = Work Week  
G = Pb-Free Indicator

### ORDERING INFORMATION

See detailed ordering and shipping information in the package dimensions section on page 2 of this data sheet.

# MC14049B, MC14050B

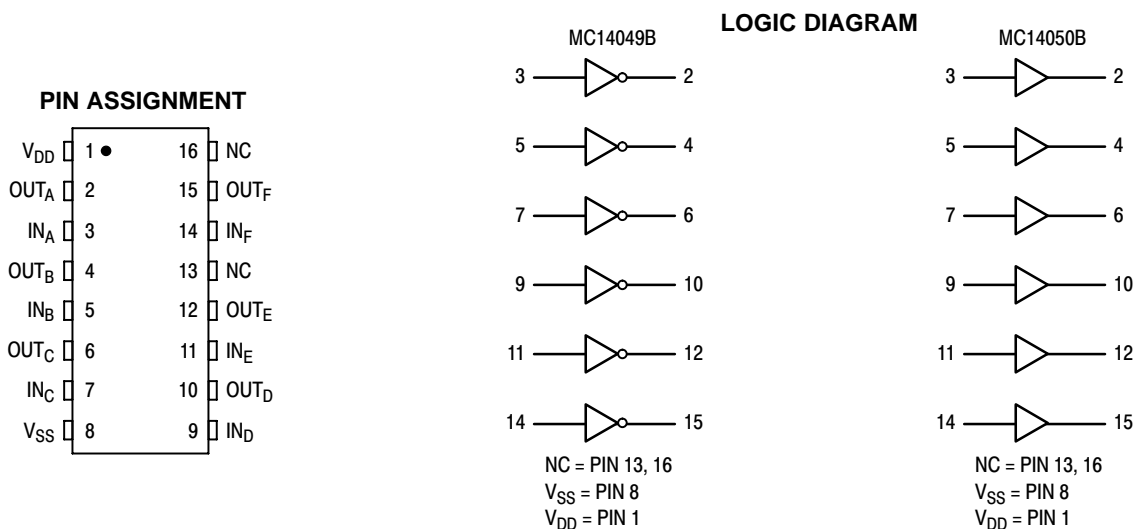

## ORDERING INFORMATION

Device	Package	Shipping <sup>†</sup>
MC14049BCP	PDIP-16	500 Units / Rail
MC14049BCPG	PDIP-16 (Pb-Free)	500 Units / Rail
MC14049BD	SOIC-16	48 Units / Rail
MC14049BDG	SOIC-16 (Pb-Free)	48 Units / Rail
MC14049BDR2	SOIC-16	2500 Units / Tape & Reel
MC14049BDR2G	SOIC-16 (Pb-Free)	2500 Units / Tape & Reel
MC14049BFEL	SOEIAJ-16	2000 Units / Tape & Reel
MC14050BCP	PDIP-16	500 Units / Rail
MC14050BCPG	PDIP-16 (Pb-Free)	500 Units / Rail
MC14050BD	SOIC-16	48 Units / Rail
MC14050BDR2	SOIC-16	2500 Units / Tape & Reel
MC14050BDR2G	SOIC-16 (Pb-Free)	2500 Units / Tape & Reel
MC14050BDT	TSSOP-16*	96 Units / Rail
MC14050BDTR2	TSSOP-16*	2500 Units / Tape & Reel
MC14050BFEL	SOEIAJ-16	2000 Units / Tape & Reel
MC14050BFELG	SOEIAJ-16 (Pb-Free)	2000 Units / Tape & Reel

<sup>†</sup>For information on tape and reel specifications, including part orientation and tape sizes, please refer to our Tape and Reel Packaging Specifications Brochure, BRD8011/D.

\*This package is inherently Pb-Free.

# MC14049B, MC14050B

## ELECTRICAL CHARACTERISTICS (Voltages Referenced to V<sub>SS</sub>)

Characteristic	Symbol	V <sub>DD</sub> Vdc	- 55°C		+ 25°C			+ 125°C		Unit	
			Min	Max	Min	Typ (Note 2)	Max	Min	Max		
Output Voltage V <sub>in</sub> = V <sub>DD</sub>	"0" Level	V <sub>OL</sub>	5.0	-	0.05	-	0	0.05	-	0.05	Vdc
			10	-	0.05	-	0	0.05	-	0.05	
15			-	0.05	-	0	0.05	-	0.05	-	
V <sub>in</sub> = 0	"1" Level	V <sub>OH</sub>	5.0	4.95	-	4.95	5.0	-	4.95	-	Vdc
			10	9.95	-	9.95	10	-	9.95	-	
			15	14.95	-	14.95	15	-	14.95	-	
Input Voltage (V <sub>O</sub> = 4.5 Vdc) (V <sub>O</sub> = 9.0 Vdc) (V <sub>O</sub> = 13.5 Vdc)	"0" Level	V <sub>IL</sub>	5.0	-	1.5	-	2.25	1.5	-	1.5	Vdc
			10	-	3.0	-	4.50	3.0	-	3.0	
15			-	4.0	-	6.75	4.0	-	4.0	-	
(V <sub>O</sub> = 0.5 Vdc) (V <sub>O</sub> = 1.0 Vdc) (V <sub>O</sub> = 1.5 Vdc)	"1" Level	V <sub>IH</sub>	5.0	3.5	-	3.5	2.75	-	3.5	-	Vdc
			10	7.0	-	7.0	5.50	-	7.0	-	
			15	11	-	11	8.25	-	11	-	
Output Drive Current (V <sub>OH</sub> = 2.5 Vdc) (V <sub>OH</sub> = 9.5 Vdc) (V <sub>OH</sub> = 13.5 Vdc)	Source	I <sub>OH</sub>	5.0	-1.6	-	-1.25	-2.5	-	-1.0	-	mAdc
			10	-1.6	-	-1.30	-2.6	-	-1.0	-	
15			-4.7	-	-3.75	-10	-	-3.0	-		
(V <sub>OL</sub> = 0.4 Vdc) (V <sub>OL</sub> = 0.5 Vdc) (V <sub>OL</sub> = 1.5 Vdc)	Sink	I <sub>OL</sub>	5.0	3.75	-	3.2	6.0	-	2.6	-	mAdc
			10	10	-	8.0	16	-	6.6	-	
			15	30	-	24	40	-	19	-	
Input Current	I <sub>in</sub>	15	-	± 0.1	-	± 0.00001	± 0.1	-	± 1.0	μAdc	
Input Capacitance (V <sub>in</sub> = 0)	C <sub>in</sub>	-	-	-	-	10	20	-	-	pF	
Quiescent Current (Per Package)	I <sub>DD</sub>	5.0	-	1.0	-	0.002	1.0	-	30	μAdc	
		10	-	2.0	-	0.004	2.0	-	60		
		15	-	4.0	-	0.006	4.0	-	120		
Total Supply Current (Notes 3 & 4) (Dynamic plus Quiescent, per package) (C <sub>L</sub> = 50 pF on all outputs, all buffers switching)	I <sub>T</sub>	5.0 10 15	$I_T = (1.8 \mu\text{A/kHz}) f + I_{DD}$ $I_T = (3.5 \mu\text{A/kHz}) f + I_{DD}$ $I_T = (5.3 \mu\text{A/kHz}) f + I_{DD}$							μAdc	

2. Data labelled "Typ" is not to be used for design purposes but is intended as an indication of the IC's potential performance.

3. The formulas given are for the typical characteristics only at + 25°C

4. To calculate total supply current at loads other than 50 pF:

$$I_T(C_L) = I_T(50 \text{ pF}) + (C_L - 50) \text{ Vfk}$$

Where: I<sub>T</sub> is in μA (per Package), C<sub>L</sub> in pF, V = (V<sub>DD</sub> - V<sub>SS</sub>) in volts, f in kHz is input frequency and k = 0.002.

# MC14049B, MC14050B

## AC SWITCHING CHARACTERISTICS (Note 5) ( $C_L = 50 \text{ pF}$ , $T_A = +25^\circ\text{C}$ )

Characteristic	Symbol	$V_{DD}$ Vdc	Min	Typ (Note 6)	Max	Unit
Output Rise Time $t_{TLH} = (0.7 \text{ ns/pF}) C_L + 65 \text{ ns}$ $t_{TLH} = (0.25 \text{ ns/pF}) C_L + 37.5 \text{ ns}$ $t_{TLH} = (0.2 \text{ ns/pF}) C_L + 30 \text{ ns}$	$t_{TLH}$	5.0 10 15	- - -	100 50 40	160 80 60	ns
Output Fall Time $t_{THL} = (0.2 \text{ ns/pF}) C_L + 30 \text{ ns}$ $t_{THL} = (0.06 \text{ ns/pF}) C_L + 17 \text{ ns}$ $t_{THL} = (0.04 \text{ ns/pF}) C_L + 13 \text{ ns}$	$t_{THL}$	5.0 10 15	- - -	40 20 15	60 40 30	ns
Propagation Delay Time $t_{PLH} = (0.33 \text{ ns/pF}) C_L + 63.5 \text{ ns}$ $t_{PLH} = (0.19 \text{ ns/pF}) C_L + 30.5 \text{ ns}$ $t_{PLH} = (0.06 \text{ ns/pF}) C_L + 27 \text{ ns}$	$t_{PLH}$	5.0 10 15	- - -	80 40 30	140 80 60	ns
Propagation Delay Time $t_{PHL} = (0.2 \text{ ns/pF}) C_L + 30 \text{ ns}$ $t_{PHL} = (0.1 \text{ ns/pF}) C_L + 15 \text{ ns}$ $t_{PHL} = (0.05 \text{ ns/pF}) C_L + 12.5 \text{ ns}$	$t_{PHL}$	5.0 10 15	- - -	40 20 15	80 40 30	ns

5. The formulas given are for the typical characteristics only at  $25^\circ\text{C}$ .

6. Data labeled "Typ" is not to be used for design purposes but is intended as an indication of the IC's potential performance.

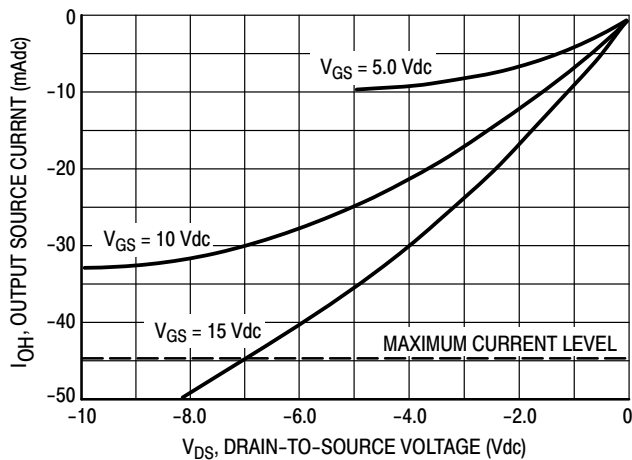
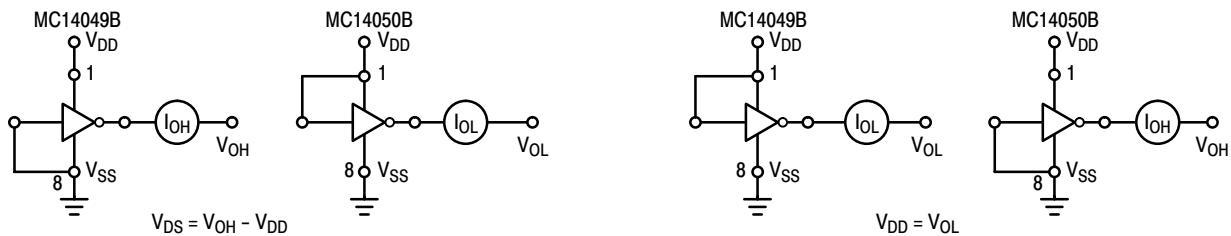

Figure 1. Typical Output Source Characteristics

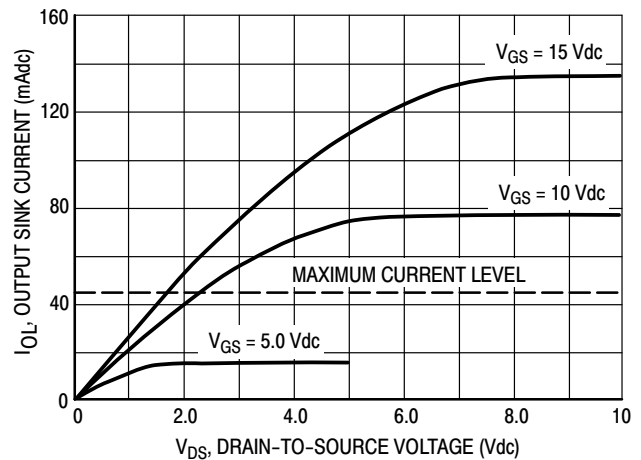
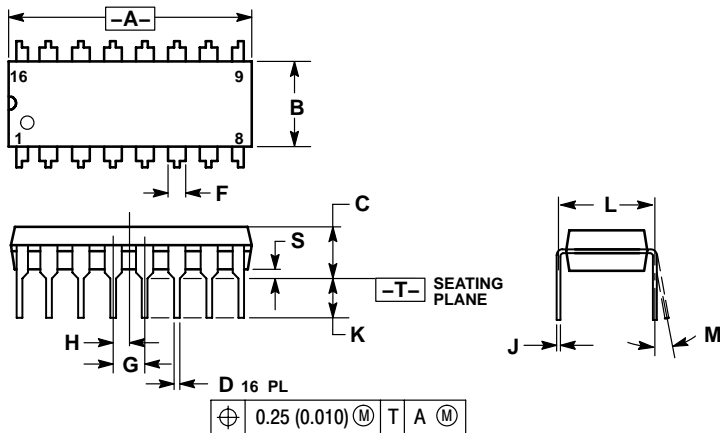

Figure 2. Typical Output Sink Characteristics

# MC14049B, MC14050B

## PACKAGE DIMENSIONS

PDIP-16  
P SUFFIX  
PLASTIC DIP PACKAGE  
CASE 648-08  
ISSUE T



- NOTES:
1. DIMENSIONING AND TOLERANCING PER ANSI Y14.5M, 1982.
  2. CONTROLLING DIMENSION: INCH.
  3. DIMENSION L TO CENTER OF LEADS WHEN FORMED PARALLEL.
  4. DIMENSION B DOES NOT INCLUDE MOLD FLASH.
  5. ROUNDED CORNERS OPTIONAL.

DIM	INCHES		MILLIMETERS	
	MIN	MAX	MIN	MAX
A	0.740	0.770	18.80	19.55
B	0.250	0.270	6.35	6.85
C	0.145	0.175	3.69	4.44
D	0.015	0.021	0.39	0.53
F	0.040	0.70	1.02	1.77
G	0.100 BSC		2.54 BSC	
H	0.050 BSC		1.27 BSC	
J	0.008	0.015	0.21	0.38
K	0.110	0.130	2.80	3.30
L	0.295	0.305	7.50	7.74
M	0° 10°		0° 10°	
S	0.020	0.040	0.51	1.01

SOIC-16  
D SUFFIX  
PLASTIC SOIC PACKAGE  
CASE 751B-05  
ISSUE J

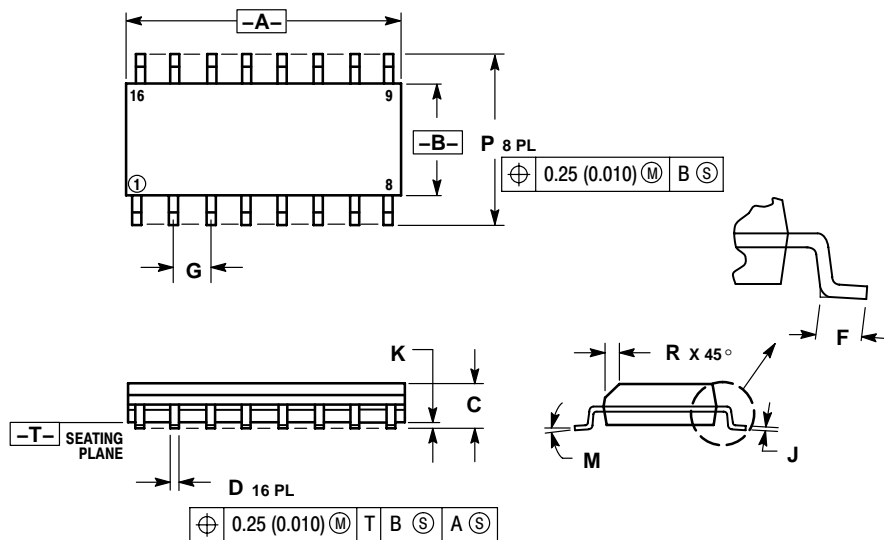

- NOTES:
1. DIMENSIONING AND TOLERANCING PER ANSI Y14.5M, 1982.
  2. CONTROLLING DIMENSION: MILLIMETER.
  3. DIMENSIONS A AND B DO NOT INCLUDE MOLD PROTRUSION.
  4. MAXIMUM MOLD PROTRUSION 0.15 (0.006) PER SIDE.
  5. DIMENSION D DOES NOT INCLUDE DAMBAR PROTRUSION. ALLOWABLE DAMBAR PROTRUSION SHALL BE 0.127 (0.005) TOTAL IN EXCESS OF THE D DIMENSION AT MAXIMUM MATERIAL CONDITION.

DIM	MILLIMETERS		INCHES	
	MIN	MAX	MIN	MAX
A	9.80	10.00	0.386	0.393
B	3.80	4.00	0.150	0.157
C	1.35	1.75	0.054	0.068
D	0.35	0.49	0.014	0.019
F	0.40	1.25	0.016	0.049
G	1.27 BSC		0.050 BSC	
J	0.19	0.25	0.008	0.009
K	0.10	0.25	0.004	0.009
M	0° 7°		0° 7°	
P	5.80	6.20	0.229	0.244
R	0.25	0.50	0.010	0.019