

8020 Series Snap-acting Momentary Pushbutton Switches



A

Pushbutton

Features/Benefits

- Positive tactile feel
- Multi-positions available
- Wide variety of termination options
- Epoxy terminal seal compatible with bottom wash cleaning
- RoHS compliant models available



Models Available

Typical Applications

- Instrumentation
- Computer peripherals
- Telecommunications equipment



Specifications

CONTACT RATING: B contact material (8X25 Models): 0.4 VA max. @ 20 V AC or DC maximum. G contact material (8X21, U8X1 Models): 1 AMP @ 120 V AC or 28 V DC or 0.4 VA max. @ 20 V AC or DC max. Note: Break-before-makecontacts. Multi-pole contacts do not make and break simultaneously. See page A-43 for additional ratings.

ELECTRICAL LIFE: 60,000 make-and-break cycles at full load.

CONTACT RESISTANCE: Below 50 mΩ typ. initial @ 2-4 V DC, 100 mA, for both silver and gold plated contacts.

INSULATION RESISTANCE: 10⁹Ω min.

DIELECTRIC STRENGTH: 1,000 Vrms min. @ sea level.

OPERATING TEMPERATURE: 8X2X MODELS: -30°C to 75°C. U8X1 MODELS: -30°C to 65°C.

CAP INSTALLATION FORCE: 10 lbs. max. permissible.

SOLDERABILITY: Per MIL-STD-202F method 208D, or EIA RS-186E method 9 (1 hour steam aging).

NOTE: Any models supplied with B, P, R, or G contact material are RoHS compliant.

NOTE: Specifications and materials listed above are for switches with standard options. For information on specific and custom switches, consult Customer Service Center.

Materials

CASE: Glass filled nylon 6/6 or diallyl phthalate (DAP), flame retardant (UL 94V-0).

PLUNGER: Glass filled nylon or glass filled polyester (PBT) (UL 94V-0).

CAP & FRAME: Nylon, black, standard.

BUSHING: Brass or zinc, nickel plated.

HOUSING: Stainless steel.

SWITCH SUPPORT: Brass or steel, matte-tin plated.

N.O. & N.C. CONTACTS: 8X21, U8X1 MODELS: G contact material: Coin silver, with gold plate over nickel plate. See page A-43 for additional contact materials. 8X25 MODELS: B contact material: Copper alloy, with gold plate over nickel plate. See page A-43 for additional contact materials.

COMMON CONTACT & ALL TERMINALS: Copper alloy, with gold plate over nickel plate.

TERMINAL SEAL: Epoxy. Refer to soldering and cleaning Technical Data Chapter.

HARDWARE: Nut & Locking Ring: Brass, nickel plated; Lockwasher: Steel, nickel plated.

Build-A-Switch

To order, simply select desired option from each category and place in the appropriate box. Available options are shown and described on pages A-30 thru A-45. For additional options not shown in catalog, consult Customer Service Center. All models have epoxy terminal seal and are compatible with all "bottom-wash" PCB cleaning methods.



Switch Function

- 8121 SPDT On-Mom. 1 Amp
- 8125 SPDT On-Mom. 0.4VA
- 8221 DPDT On-Mom. 1 Amp
- 8225 DPDT On-Mom. 0.4VA
- 8321 3PDT On-Mom. 1 Amp
- 8325 3PDT On-Mom. 0.4VA
- 8421 4PDT On-Mom. 1 Amp
- 8425 4PDT On-Mom. 0.4VA

Note: UL/CSA models available, see page A-30 and A-31.

Actuator or Plunger

- S Plunger
- NONE Snap-in
- J80 Snap-in
- J81 Snap-in w/frame
- J82 Snap-in w/frame for LED
- J83 Snap-in w/frame & flush cap
- J84 Snap-in w/frame for LED, flush cap
- J85 Snap-in w/frame & LED
- J95 PC w/V-bracket & LED
- L Plunger
- M Snap-fitting plunger

Bushing

- D9 .280" high, keyway
- H .250" high, flat
- NONE No bushing choice required
- D .280" high, keyway
- D2 .288" high, flat
- D3 .180" high
- D8 .288" high, flat
- H9 .250" high, flat, hi torque
- Y .350" high, keyway
- Y3 6.35mm high, keyway, hi torque
- Y4 .378" high, flat, hi torque
- Y9 .350" high, keyway

Contact Material

- B Gold
- P Gold, matte-tin
- G Gold over silver
- R Gold over silver, matte-tin

Seal

- E Epoxy
- I Epoxy potted base

Cap Color

- 2 Black
- NONE Models without caps
- 1 White
- 3 Red
- 4 Orange
- 5 Yellow
- 6 Green
- 7 Blue
- 9 Gray

Frame Color

- 2 Black
- NONE Models without frame
- 1 White
- 3 Red
- 5 Yellow
- 6 Green
- 9 Gray

LED Color

- 3 Red
- NONE Models without LED
- 5 Yellow
- 6 Green

Terminations

- A Right angle, PC thru-hole
- AV2 Vertical right angle, PC thru-hole
- C PC Thru-hole
- Z Solder lug
- A2 Right angle, PC thru-hole
- A3 Right angle, snap-in, PC thru-hole
- A4 Right angle, PC thru-hole, reversed terminals
- A6 Right angle, PC thru-hole
- AV Vertical right angle, PC thru-hole
- AV1 Vertical right angle, PC thru-hole
- AV3 Vertical right angle, snap-in, PC thru-hole
- R Right angle with PCB
- R2 Right angle with PCB, reversed terminals
- V2 .555" high, V-bracket
- V3 .460" high, V-bracket
- V4 .630" high, V-bracket
- V6 .460" high, V-bracket
- V7 .630" high, V-bracket
- V8 .953" high, V-bracket
- V9 1.150" high, V-bracket
- V31 .460" high, snap-in V-bracket
- V61 .460" high, snap-in V-bracket
- W .750" long, wire wrap
- W1 .964" long, wire wrap
- W3 .425" long, wire wrap
- W4 1.062" long, wire wrap
- Z3 Quick connect



Dimensions are shown: Inches (mm)
Specifications and dimensions subject to change



8020 Series Snap-acting Momentary Pushbutton Switches

SWITCH FUNCTION

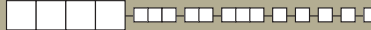

Pushbutton A

NO. POLES	MODEL NO.	UL/CSA* MODEL NO.	SWITCH FUNCTION		CONNECTED TERMINALS		SCHEMATIC
			POS. 1	POS. 2	POS. 1	POS. 2	
SP	8121	U811	ON	MOM.	1-3	1-2	
	8125		ON	MOM.			
<p>SPDT</p> <p>Part number shown: 8121SHZGE</p>							
DP	8221	U821	ON	MOM.	1-3,4-6	1-2,4-5	
	8225		ON	MOM.			
<p>DPDT</p> <p>Part number shown: 8221SHZGE</p>							
3P	8321	U831	ON	MOM.	1-3,4-6,7-9	1-2,4-5,7-8	
	8325		ON	MOM.			
<p>3PDT</p> <p>Part number shown: 8321SHZGE</p>							

MOM. = Momentary

*U811 thru U841 model numbers with all options (except R, R2 terminations) when ordered with G or R contact material.

8X25 models must be ordered with B or P contact material.

8X21 and U8X1 models must be ordered with G or R contact material.

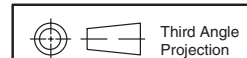

Dimensions are shown: Inches (mm)
Specifications and dimensions subject to change

www.ck-components.com

8020 Series Snap-acting Momentary Pushbutton Switches



A

Pushbutton

SWITCH FUNCTION

NO. POLES	MODEL NO.	UL/CSA* MODEL NO.	SWITCH FUNCTION		CONNECTED TERMINALS		SCHEMATIC
			POS. 1	POS. 2	POS. 1	POS. 2	
4P	8421	U841	ON	MOM.	1-3,4-6,7-9,10-12	1-2,4-5,7-8,10-11	
	8425		ON	MOM.			

4PDT

Part number shown: 8421SHZGE

Terminal Nos. For Reference Only

MOM. = Momentary

* U811 thru U841 model numbers with all options (except R, R2 terminations) when ordered with G or R contact material.

8X25 models must be ordered with B or P contact material.

8X21 and U8X1 models must be ordered with G or R contact material.

ACTUATOR—SNAP-IN FRONT MOUNT

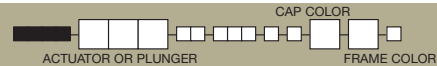

OPTION CODE	CAP AND FRAME COLOR
2	BLACK
NONE	No Frame Color (J80 option)
1	WHITE
3	RED
4	ORANGE
5	YELLOW
6	GREEN
7	BLUE
9	GRAY

Other colors available, consult Customer Service Center. Cap and Frame Finish: matte.

NOTE: Caps and frames available separately, see pages A-44 and A-45.

J80 SNAP-IN

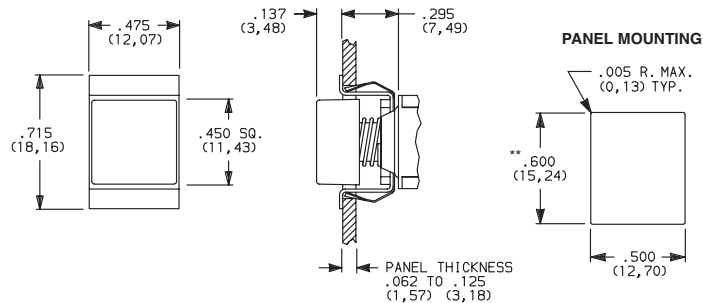

NOTE: No frame color choice required.

** Increase this dim. to .620/.625 (15,75/15,88) for .091/.125 (2,31/3,18) thk. panels.

J81 SNAP-IN WITH FRAME

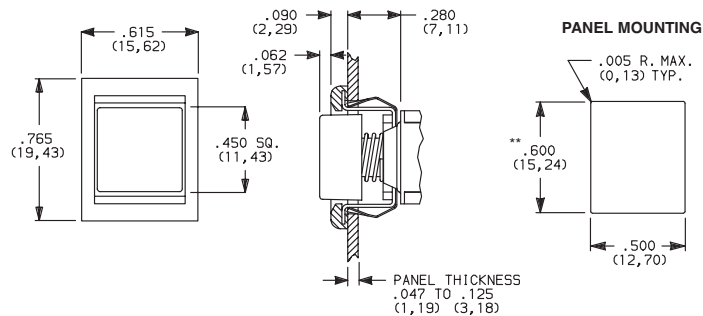

NOTE: Available with C, W-W4, Z or Z3 terminations and SPDT and DPDT models only.

** Increase this dim. to .620/.625 (15,75/15,88) for .091/.125 (2,31/3,18) thk. panels.



Third Angle Projection
Dimensions are shown: Inches (mm)
Specifications and dimensions subject to change





8020 Series Snap-acting Momentary Pushbutton Switches

ACTUATOR—SNAP-IN FRONT MOUNT

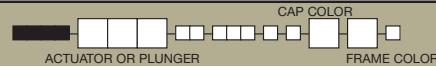

J83 SNAP-IN WITH FRAME AND FLUSH CAP

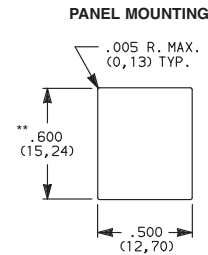
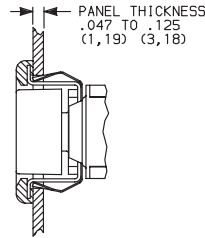
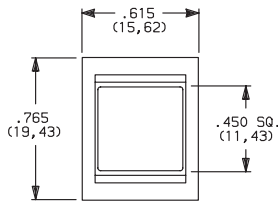

J82 SNAP-IN WITH FRAME FOR LED

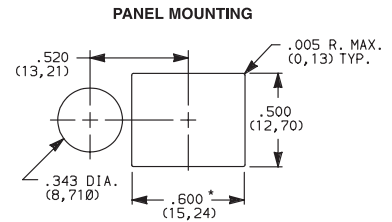
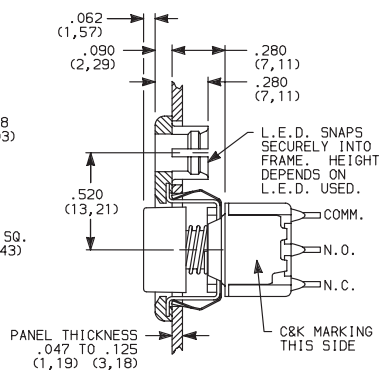
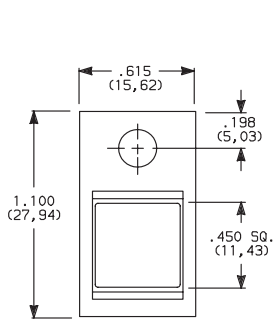

* Increase this dim. to .620/.625 (15,75/15,88) for .091/.125 (2,31/3,18) thk. panels.

LED not included.
For LED information, see page A-45.

J84 SNAP-IN WITH FRAME FOR LED, FLUSH CAP

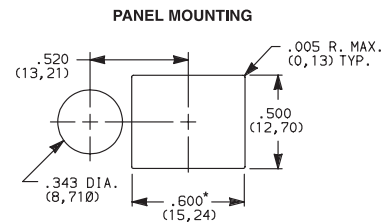
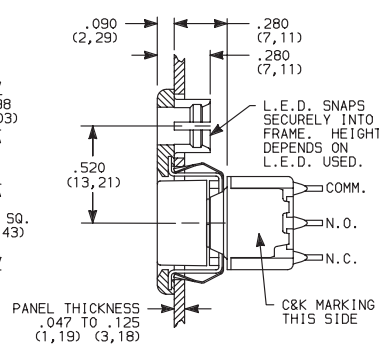
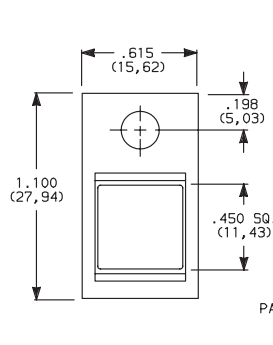

* Increase this dim. to .620/.625 (15,75/15,88) for .091/.125 (2,31/3,18) thk. panels.

LED not included.
For LED information, see page A-45.

OPTION CODE	CAP AND FRAME COLOR
2	BLACK
1	WHITE
3	RED
4	ORANGE
5	YELLOW
6	GREEN
7	BLUE
9	GRAY

Other colors available, consult Customer Service Center.
Cap and Frame Finish: matte.

Available with C, W-W4, Z or Z3 terminations and SPDT and DPDT models only.

NOTE: Caps and frames available separately, see pages A-44 and A-45.

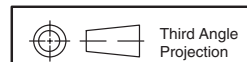

Third Angle Projection

Dimensions are shown: Inches (mm)
Specifications and dimensions subject to change

www.ck-components.com



8020 Series Snap-acting Momentary Pushbutton Switches



A

Pushbutton

ACTUATOR—SNAP-IN FRONT MOUNT

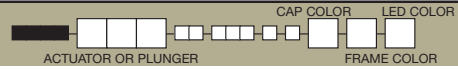

J85 SNAP-IN WITH FRAME AND LED

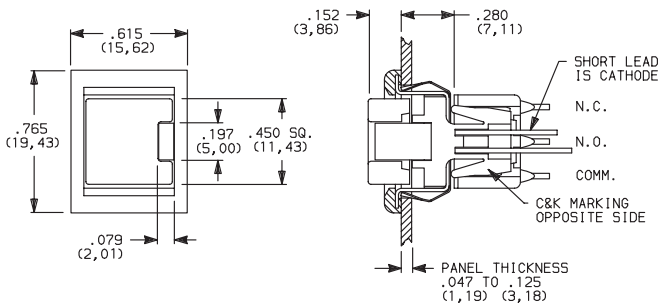

PANEL MOUNTING

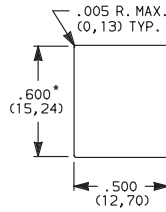

* Increase this dim. to .620/.625 (15,75/15,88) for .091/.125 (2,31/3,18) thk. panels.



8121J85ZGE223
SPST

Available with C, W-W4, Z or Z3 terminations and SPDT models only. For LED information see page A-45.

NOTE: Caps & frames available separately, see pages A-44 and A-45.

OPTION CODE	CAP AND FRAME COLOR
2	BLACK
1	WHITE
3	RED
4	ORANGE
5	YELLOW
6	GREEN
7	BLUE
9	GRAY

OPTION CODE	LED COLOR
3	RED
5	YELLOW
6	GREEN

For LED information see page A-45.

ACTUATOR—PC MOUNT

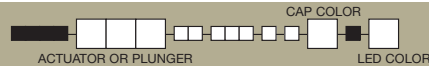

J95 PC WITH V-BRACKET AND LED

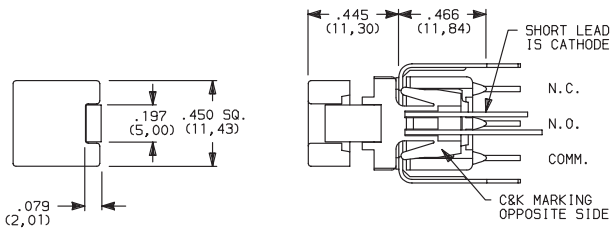

PC MOUNTING

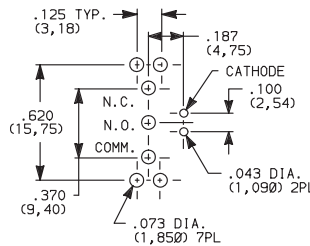

8121J95V3GE23
SPST

OPTION CODE	CAP AND FRAME COLOR
2	BLACK
1	WHITE
3	RED
4	ORANGE
5	YELLOW
6	GREEN
7	BLUE
9	GRAY

OPTION CODE	LED COLOR
3	RED
5	YELLOW
6	GREEN

For LED information see page A-45.

NOTE: Caps available separately, see page A-44. Available with V3 terminations and SPDT models only.



Third Angle Projection

Dimensions are shown: Inches (mm)
Specifications and dimensions subject to change



www.ck-components.com



8020 Series Snap-acting Momentary Pushbutton Switches

Pushbutton A

PLUNGER

ACTUATOR OR PLUNGER

S PLUNGER

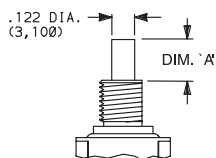

NONE NO PLUNGER CHOICE REQUIRED (JXX ACTUATORS)

AVAILABLE BUSHINGS	DIM. 'A' FOR C, W-W4, Z & Z3 TERMINATIONS	DIM. 'A' FOR A, A2, A3, A4, A6, AV-A3, R & R2 TERMINATIONS	DIM. 'A' FOR V3-V61 TERMINATIONS
D, D9	.244 (6,20)	.228 (5,79)	.224 (5,69)
H, H9	.218 (5,54)	.202 (5,13)	.198 (5,03)
Y, Y9	.203 (5,16)	.187 (4,75)	.183 (4,65)
Y3	(5,54)	(5,13)	(5,03)
Y4	.185 (4,70)	.169 (4,29)	.165 (4,19)
D2, D8	N/A	.232 (5,89)	.228 (5,79)
D3	N/A	.162 (4,11)	.158 (4,01)

L PLUNGER

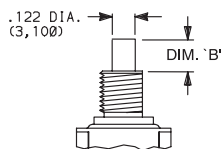

AVAILABLE BUSHINGS	DIM. 'B' FOR C, W-W4, Z & Z3 TERMINATIONS	DIM. 'B' FOR A, A2, A3, A4, A6, AV-A3, R & R2 TERMINATIONS	DIM. 'B' FOR V3-V61 TERMINATIONS
Y, Y9	.178 (4,52)	.162 (4,11)	.158 (4,01)
Y4	.090 (2,29)	.074 (1,88)	.070 (1,78)

M SNAP-FITTING PLUNGER

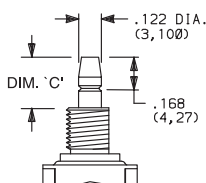

AVAILABLE BUSHINGS	DIM. 'C' FOR C, W-W4, Z & Z3 TERMINATIONS	DIM. 'C' FOR A, A2, A3, A4, A6, AV-A3, R & R2 TERMINATIONS	DIM. 'C' FOR V3-V61 TERMINATIONS
D, D9	.297 (7,54)	.281 (7,14)	.277 (7,04)
H, H9	.267 (6,78)	.251 (6,38)	.247 (6,27)
Y, Y9	.259 (6,58)	.243 (6,17)	.239 (6,07)
Y3	(6,78)	(6,37)	(6,27)
Y4	.259 (6,58)	.243 (6,17)	.239 (6,07)
D2, D8	N/A	.273 (6,93)	.269 (6,83)
D3	N/A	.361 (9,17)	.357 (9,07)

N/A = NOT AVAILABLE

NOTE: When selecting plunger option, bushing selection must also be made, see next page. No plunger option is required when any JXX actuator option is selected. Additional plunger lengths are available on SPDT and DPDT models, consult Customer Service Center. Not all plunger lengths sufficient for use with caps, see page A-44.

BUSHING

NONE NO BUSHING CHOICE REQUIRED (JXX ACTUATORS)

D .280" HIGH THREADED, KEYWAY
D9 .280" HIGH UNTHREADED, KEYWAY

H .250" HIGH THREADED, FLAT
H9 .250" HIGH UNTHREADED, FLAT

Y .350" HIGH THREADED, KEYWAY
Y9 .350" HIGH UNTHREADED, KEYWAY

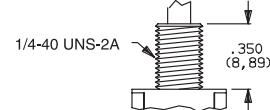
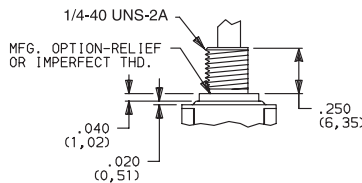
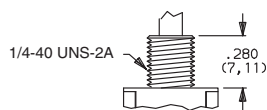
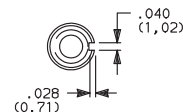
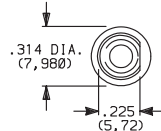
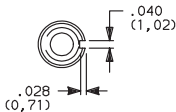

D9 bushing standard with A-A6, R, R2 AV-AV3 terminations.

H bushing standard with C, W-W4, Z or Z3 terminations. H, H9 bushings not available on single pole models with A3-A6, R, R2 terminations.

Will withstand 12 in./lbs. of torque with no distortion.



Dimensions are shown: Inches (mm)
 Specifications and dimensions subject to change



www.ck-components.com

8020 Series Snap-acting Momentary Pushbutton Switches



A Pushbutton

BUSHING

Y3 6.35mm THREADED, KEYWAY

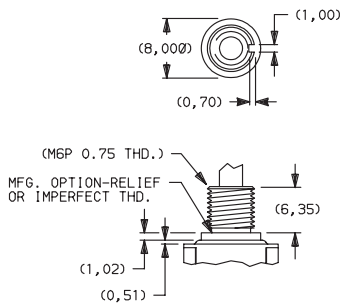

Y4 .378" HIGH THREADED, FLAT

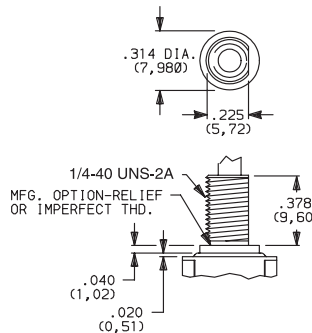

D2 .288" HIGH THREADED, FLAT

D8 .288" HIGH UNTHREADED, FLAT

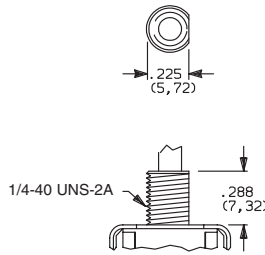

D3 .180" HIGH UNTHREADED

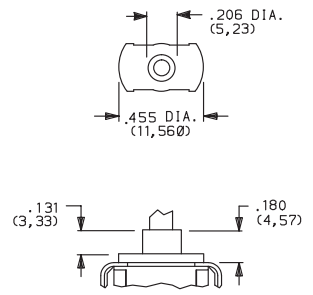

Y3 & Y4 bushings not available on single pole models with A3-A6, R, R2 terminations. Will withstand 12 in./lbs. of torque with no distortion.

D2, D8 bushings not available with C, W-W4, Z, Z3 terminations.

D3 bushing available with A, A2, A3, AV, AV2, AV3 and V2-V61 terminations only.

NOTE: No bushing option choice required when JXX actuator option is selected. When selecting bushing option, plunger selection must also be made, see previous page. Plunger lengths vary with bushing and termination options selected.

PANEL MOUNTING

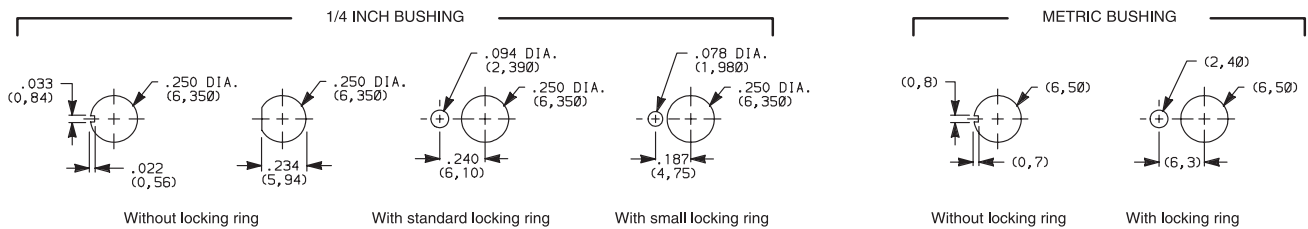

NOTE: Two mounting nuts, locking ring and lockwasher supplied standard with threaded bushings. Optional mounting nut and locking ring styles available, see section "Technical Data and Additional Hardware".

TERMINATIONS

Z SOLDER LUG

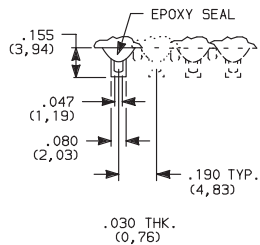

SPDT thru 4PDT

Not available with J95 actuator, P or R contact material.

C PC THRU-HOLE

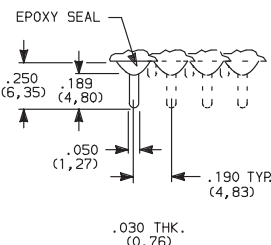

SPDT thru 4PDT

Not available with J95 actuator option.

PC MOUNTING

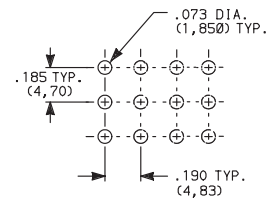

Z3 QUICK CONNECT

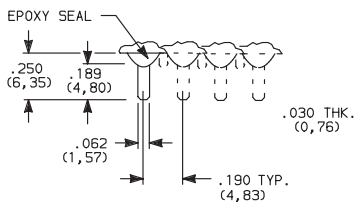

SPDT thru 4PDT

Not available with J95 actuator, P or R contact material. Mating quick connector available, order part number 530100000, page A-44.

W W1, W3, W4 WIRE WRAP

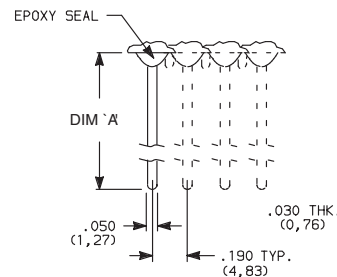

SPDT thru 4PDT

Not available with J95 actuator option.

OPTION CODE	DIM 'A'
W	.750 (19,05)
W1	.964 (24,49)
W3	.425 (10,80)
W4	1.062 (26,97)



Dimensions are shown: Inches (mm)
Specifications and dimensions subject to change



www.ck-components.com

8020 Series Snap-acting Momentary Pushbutton Switches



A

Pushbutton

TERMINATIONS



A RIGHT ANGLE, PC THRU-HOLE

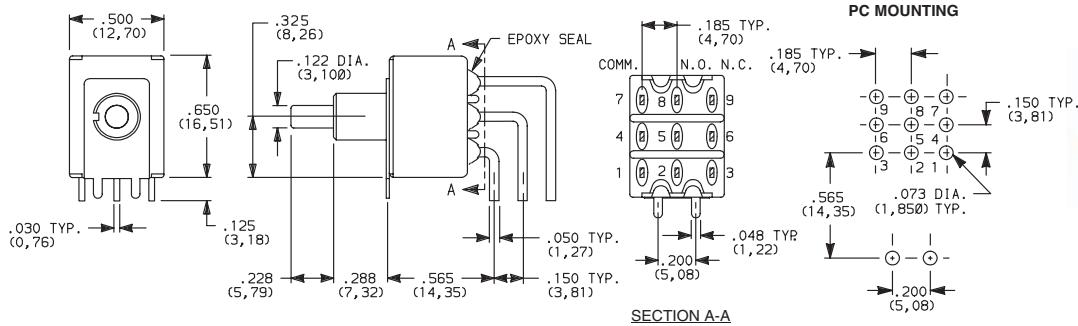

8321SD9AGE
3PDT

Not available with JXX actuators and I seal option.
Terminal bend radii and lead-in manufacturing option.

A2 RIGHT ANGLE, PC THRU-HOLE

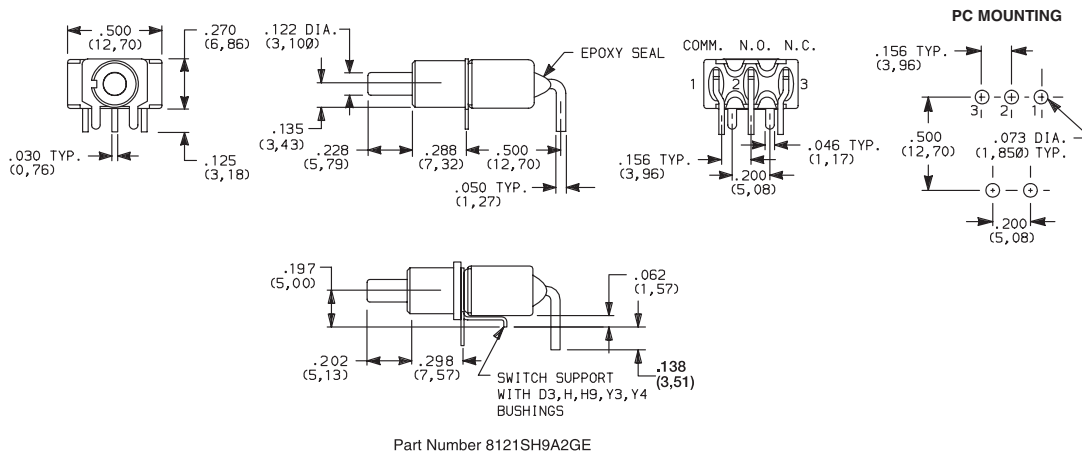

8121SD9A2GE
SPDT

Not available with JXX actuators, I seal option.
Terminal bend radii and lead-in manufacturing option.

A4 RIGHT ANGLE, PC THRU-HOLE, REVERSED TERMINALS

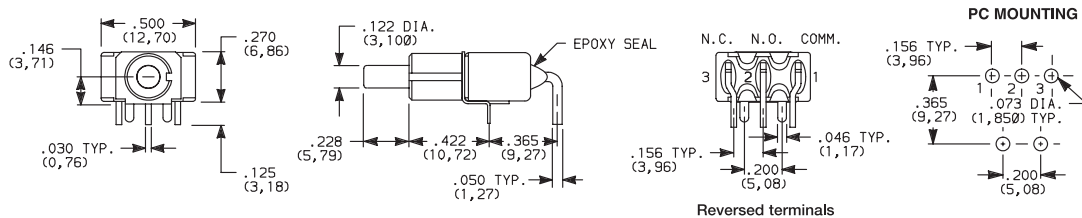

8121SD9A4GE
SPDT

Not available with JXX actuators, D3, H, H9, Y3, Y4 bushings and I seal.
Terminal bend radii and lead-in manufacturing option.

The A4 and R2 termination options are functionally identical and fit the same PC mounting pattern. The switches, however, are shifted relative to the mounting holes. The PC pattern must clear the switch support legs. Unlike the R2, the A4 option is available with UL/CSA.

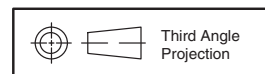

Third Angle Projection
Dimensions are shown: Inches (mm)
Specifications and dimensions subject to change





8020 Series Snap-acting Momentary Pushbutton Switches

TERMINATIONS



Pushbutton

A6 RIGHT ANGLE, PC THRU-HOLE



8121SD9A6GE SPDT

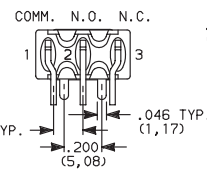
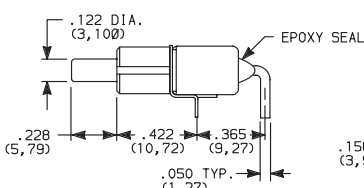
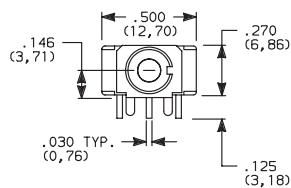

PC MOUNTING

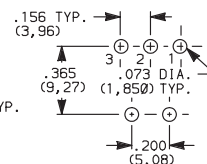

The A6 and R termination options are functionally identical and fit the same PC mounting pattern. The switches, however, are shifted relative to the mounting holes. The PC pattern must clear the switch support legs. Unlike the R, the A6 option is available with UL/CSA.

Not available with JXX actuators, D3, H, H9, Y3, Y4 bushings and I seal. Terminal bend radii and lead-in manufacturing option.

R RIGHT ANGLE WITH PCB



8121SD9RGE SPDT

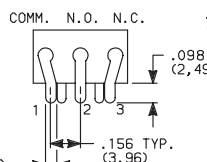
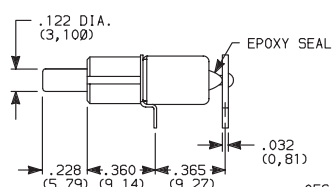
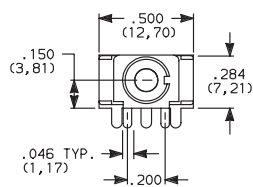

PC MOUNTING

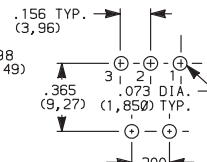

Not available with JXX actuators, D3, H, H9, Y3, Y4 bushings, I seal option. R termination not UL/CSA approved.

R2 RIGHT ANGLE WITH PCB, REVERSED TERMINALS



8121SD9R2GE SPDT

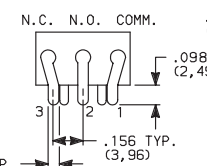
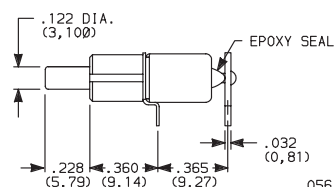
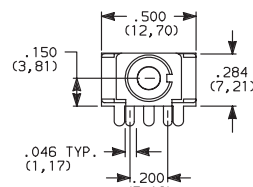

Reversed terminals

PC MOUNTING

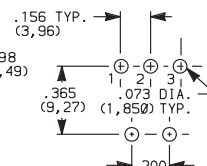

Not available with JXX actuators, D3, H, H9, Y3, Y4 bushings, I seal option. R2 termination not UL/CSA approved.

AV VERTICAL RIGHT ANGLE, PC THRU-HOLE, .100" PITCH



8121SD9AVGE SPDT

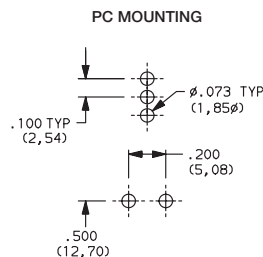
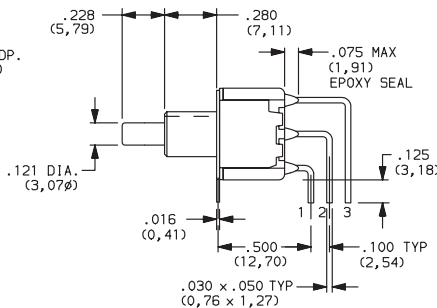
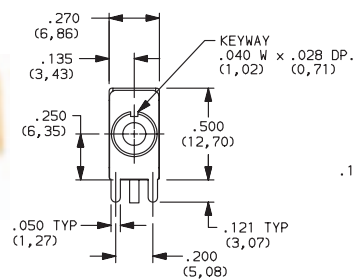

Dimensions are shown: Inches (mm)
Specifications and dimensions subject to change



www.ck-components.com

8020 Series Snap-acting Momentary Pushbutton Switches



A

Pushbutton

TERMINATIONS



AV2 VERTICAL RIGHT ANGLE, PC THRU-HOLE, .150" PITCH

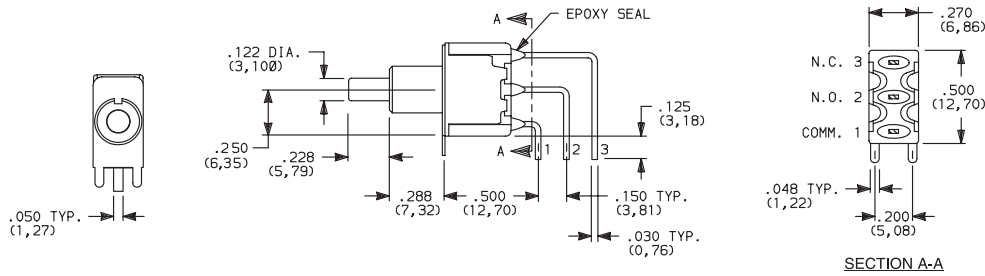

8121SD9AV2GE SPDT

AV3 VERTICAL RIGHT ANGLE, SNAP-IN, PC THRU-HOLE, .150" PITCH

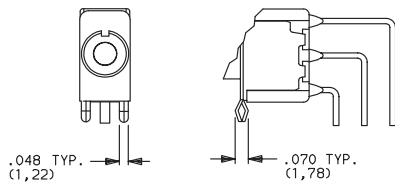

AV1 VERTICAL RIGHT ANGLE, EXTENDED, PC THRU-HOLE, .150" PITCH

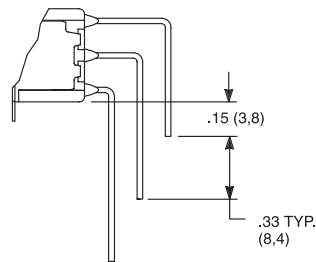

PC MOUNTING

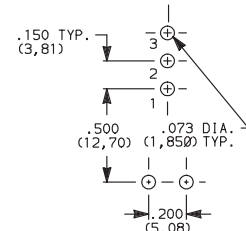

Not available with JXX actuators and I seal.
Terminal bend radii and lead-in manufacturing option.

AV2 VERTICAL RIGHT ANGLE, PC THRU-HOLE, .150" PITCH

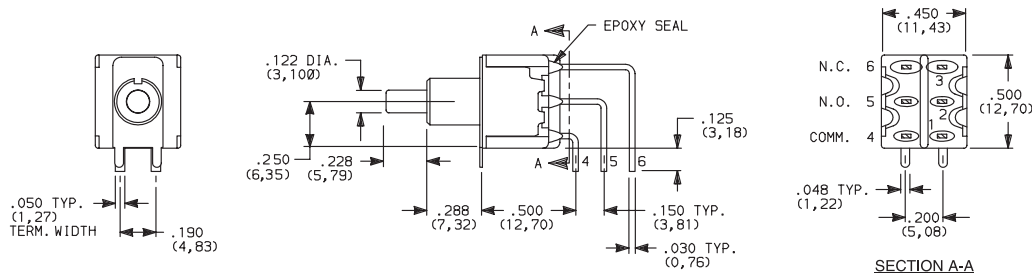

8221SD9AV2GE DPDT

AV3 VERTICAL RIGHT ANGLE, SNAP-IN, PC THRU-HOLE, .150" PITCH

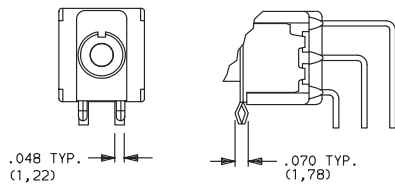

AV1 VERTICAL RIGHT ANGLE, EXTENDED, PC THRU-HOLE, .150" PITCH

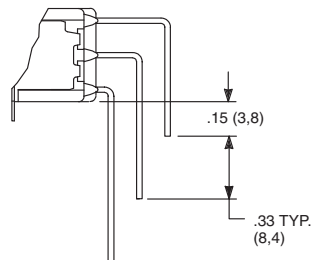

PC MOUNTING

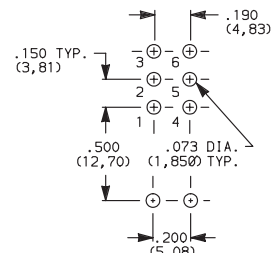

Not available with JXX actuators and I seal.
Terminal bend radii and lead-in manufacturing option.

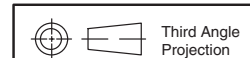

Dimensions are shown: Inches (mm)
Specifications and dimensions subject to change





A

Pushbutton

8020 Series Snap-acting Momentary Pushbutton Switches

TERMINATIONS



AV2 VERTICAL RIGHT ANGLE, PC THRU-HOLE, 150° PITCH



8321SD9AV2GE
3PDT

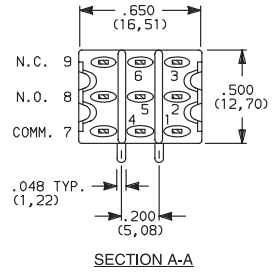
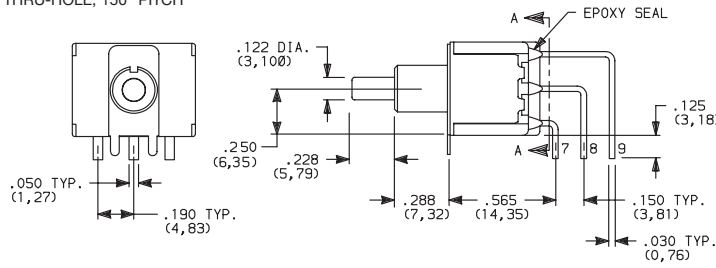

AV3 VERTICAL RIGHT ANGLE, SNAP-IN, PC THRU-HOLE, .150° PITCH

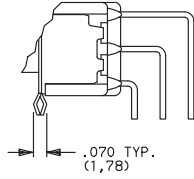
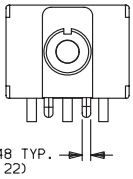

AV1 VERTICAL RIGHT ANGLE, EXTENDED, PC THRU-HOLE, .150° PITCH

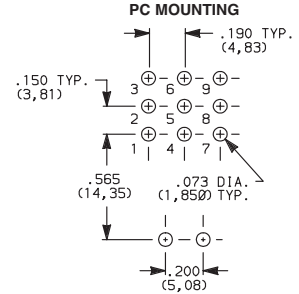
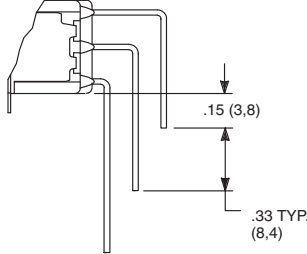

Not available with JXX actuators and I seal.
Terminal bend radii and lead-in manufacturing option.

AV2 VERTICAL RIGHT ANGLE, PC THRU-HOLE, 150° PITCH



8421SD9AV2GE
4PDT

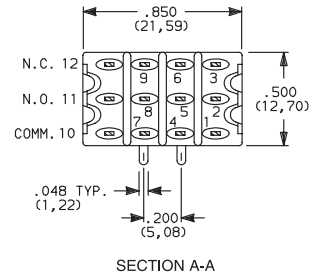
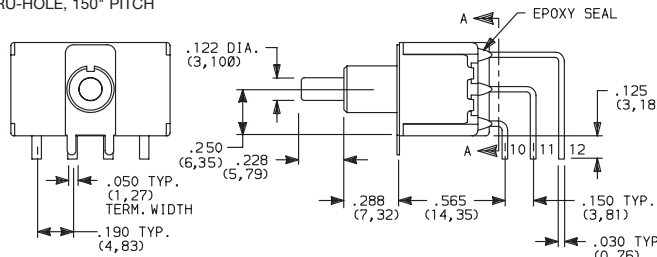

AV3 VERTICAL RIGHT ANGLE, SNAP-IN, PC THRU-HOLE, .150° PITCH

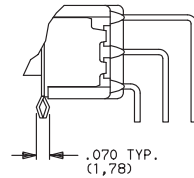
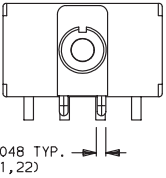

AV1 VERTICAL RIGHT ANGLE, EXTENDED, PC THRU-HOLE, .150° PITCH

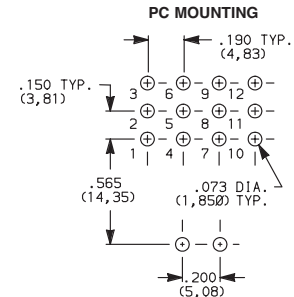
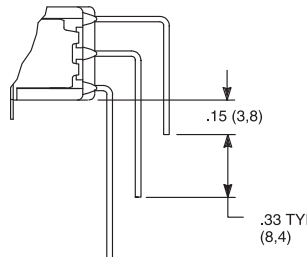

Not available with JXX actuators and I seal.
Terminal bend radii and lead-in manufacturing option.

V2, V6, V7, V8 VERTICAL MOUNT, V-BRACKET

V61 VERTICAL MOUNT, V-BRACKET, SNAP-IN



8121SD3_GE
SPDT

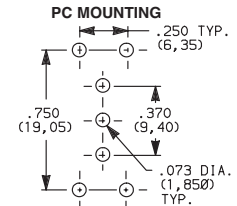
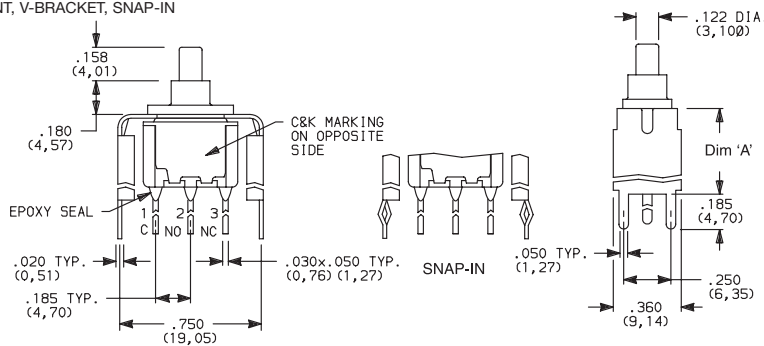

OPTION CODE	DIM 'A'
V2	.555 (14,10)
V6, V61	.460 (11,68)
V7	.630 (16,00)
V8	.953 (24,21)

Not available with JXX actuators and I seal.

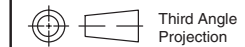

Dimensions are shown: Inches (mm)
Specifications and dimensions subject to change

www.ck-components.com

8020 Series Snap-acting Momentary Pushbutton Switches



A

Pushbutton

TERMINATIONS



V2, V6, V7, V8 VERTICAL MOUNT, V-BRACKET

V61 VERTICAL MOUNT, V-BRACKET, SNAP-IN

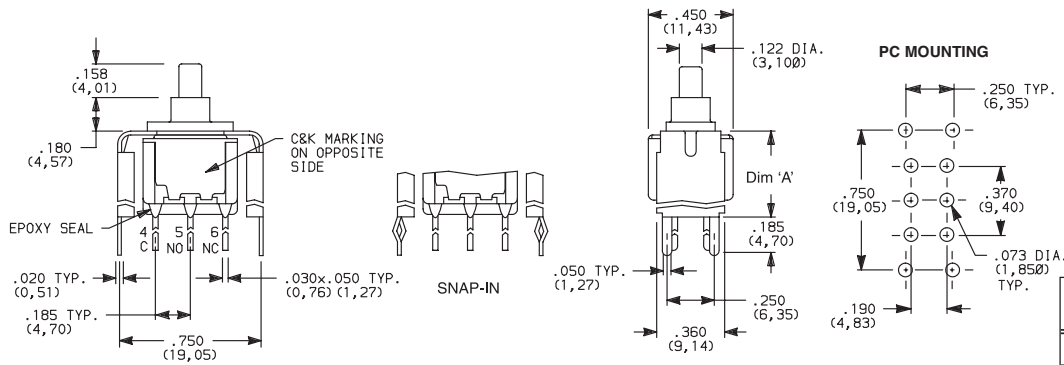

8221SD3_GE DPDT

OPTION CODE	DIM 'A'
V2	.555 (14,10)
V6, V61	.460 (11,68)
V7	.630 (16,00)
V8	.953 (24,21)

Not available with JXX actuators and I seal.

V2, V7, V8 VERTICAL MOUNT, V-BRACKET

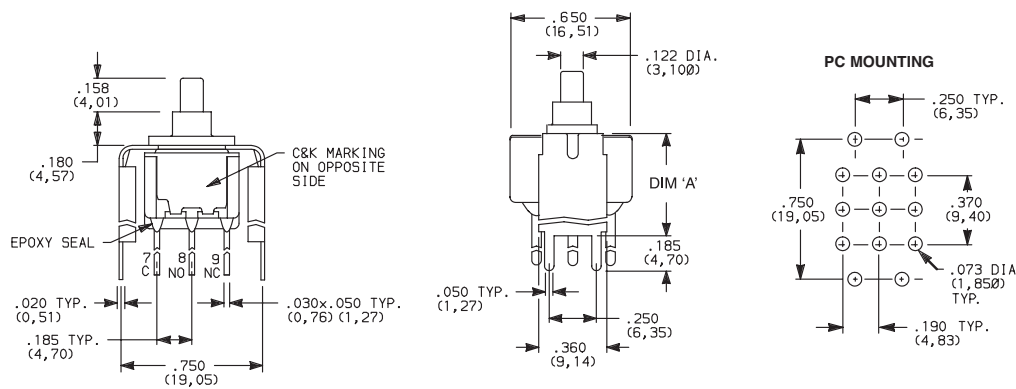

8321SD3_GE 3PDT

OPTION CODE	DIM 'A'
V2	.555 (14,10)
V7	.630 (16,00)
V8	.953 (24,21)

Not available with JXX actuators and I seal.

V2, V7, V8 VERTICAL MOUNT, V-BRACKET

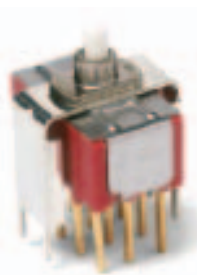
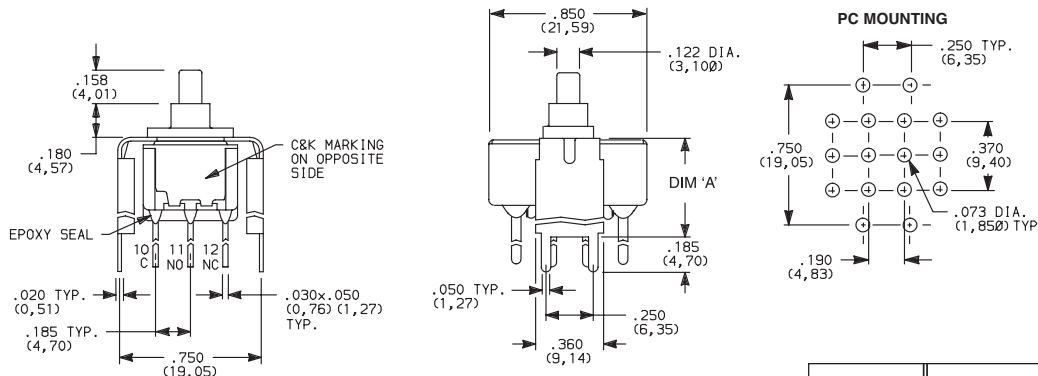

8421SD3_GE 4PDT

OPTION CODE	DIM 'A'
V2	.555 (14,10)
V7	.630 (16,00)
V8	.953 (24,21)

Not available with JXX actuators and I seal.



Third Angle Projection
Dimensions are shown: Inches (mm)
Specifications and dimensions subject to change



www.ck-components.com



8020 Series Snap-acting Momentary Pushbutton Switches

TERMINATIONS



Pushbutton A

V3, V4, V9 VERTICAL MOUNT, V-BRACKET

V31 VERTICAL MOUNT, V-BRACKET, SNAP-IN

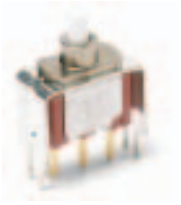

8121SD3_GE
SPDT

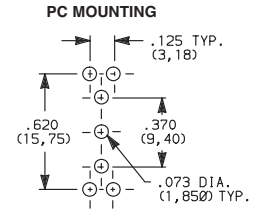
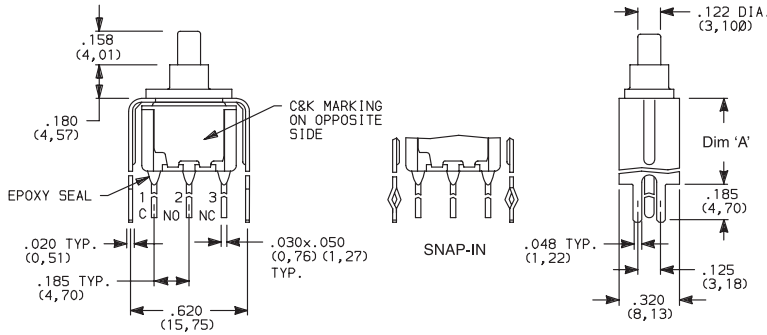

OPTION CODE	DIM 'A'
V3, V31	.460 (11,68)
V4	.630 (16,00)
V9	1.150 (29,21)

Not available with J8X actuators and I seal.

V3, V4, V9 VERTICAL MOUNT, V-BRACKET

V31 VERTICAL MOUNT, V-BRACKET, SNAP-IN



8221SD3_GE
DPDT

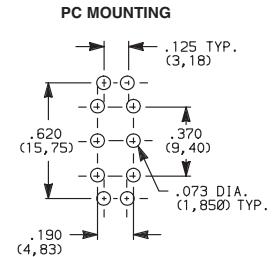
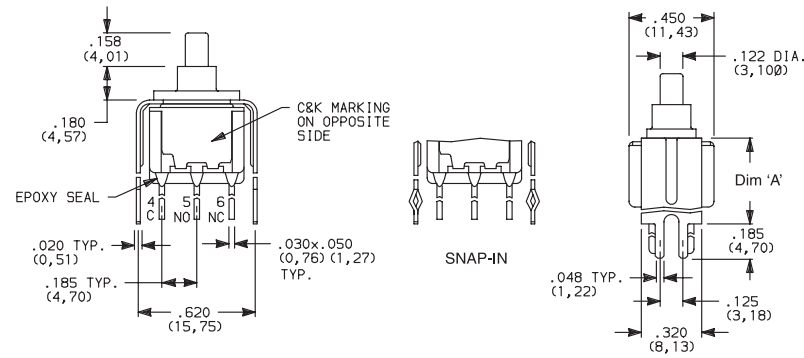

OPTION CODE	DIM 'A'
V3, V31	.460 (11,68)
V4	.630 (16,00)
V9	1.150 (29,21)

Not available with J8X actuators and I seal.

V4, V9 VERTICAL MOUNT, V-BRACKET

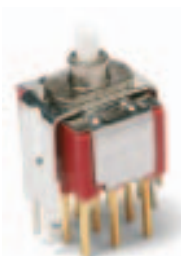

8321SD3V4GE
3PDT

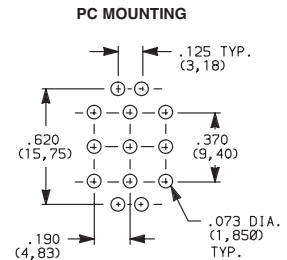
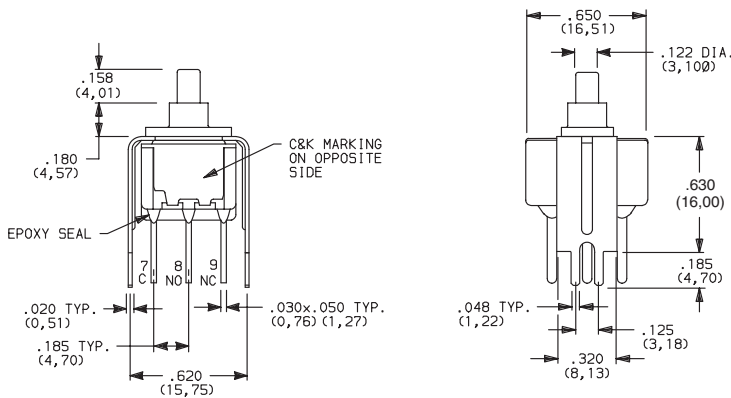

OPTION CODE	DIM 'A'
V4	.630 (16,00)
V9	1.150 (29,21)

Not available with JXX actuators and I seal.



Dimensions are shown: Inches (mm)
Specifications and dimensions subject to change

www.ck-components.com

8020 Series Snap-acting Momentary Pushbutton Switches



A

Pushbutton

TERMINATIONS



V4, V9 VERTICAL MOUNT, V-BRACKET

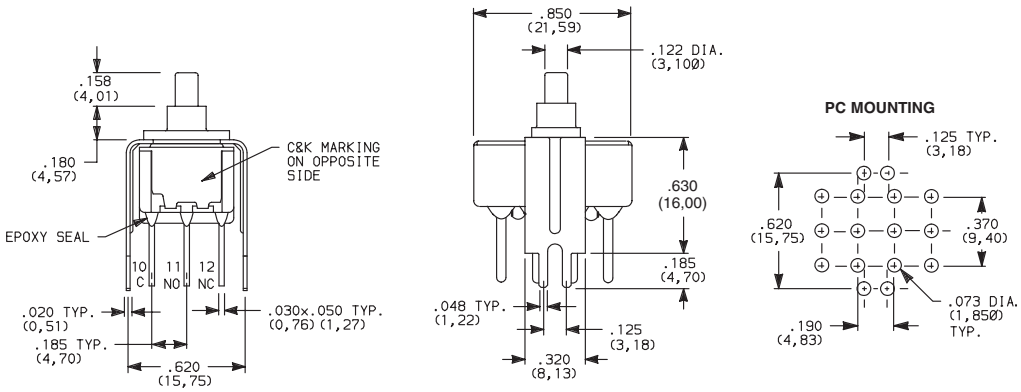

8421SD3V4GE
4PDT

OPTION CODE	DIM 'A'
V4	.630 (16,00)
V9	1.150 (29,21)

Not available with JXX actuators and I seal.

CONTACT MATERIAL



OPTION CODE	CONTACT MATERIAL	TERMINAL PLATING	RATINGS	
B	GOLD 1	GOLD 1	LOW LEVEL/DRY CIRCUIT	8x25 MODELS ONLY: 0.4 MAX. @ 20 V AC OR DC MAX.
P		MATTE-TIN 4		
G	GOLD OVER SILVER 2,3	GOLD 3	LOW LEVEL/DRY CIRCUIT OR POWER	8X21, U8X1 MODELS ONLY: 0.4 VA MAX @ 20 V AC OR DC MAX. OR 1 AMP @ 120 V AC OR 28 V DC.
R		MATTE-TIN 4		

* Note: See Technical Data section of this catalog for RoHS compliant and compatible definitions and specifications.

- 1 ALL CONTACTS & TERMINALS: Copper alloy, with gold plate over nickel plate.
- 2 N.O. AND N.C. CONTACTS: Coin silver, with gold plate over nickel plate.
- 3 COMMON CONTACTS & ALL TERMINALS: Copper alloy, with gold plate over nickel plate.
- 4 TERMINALS: Copper alloy, with matte-tin over nickel plate.

NOTE: Any models supplied with B, P, R or G contact material are RoHS compliant.
 U811-U841 models with all options (except R, R2 terminations) when ordered with mandatory G or R contact material.
 B or P contact material must be ordered with 8X25 models.
 G or R contact material must be ordered with 8X21, U8X1 models.
 P or R contact material not available with Z, Z3 terminations.

SEAL



E EPOXY SEAL

I EPOXY POTTED BASE

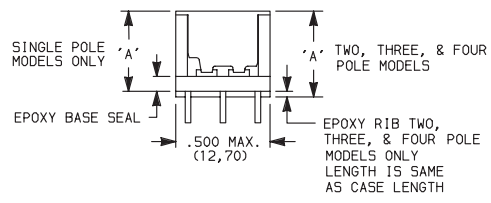
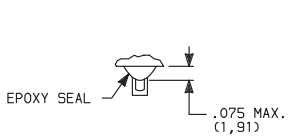

NO. POLES	DIM 'A'
SP	.410 (10,41)
DP	.440 (11,18)
3P	.505 (12,83)
4P	.505 (12,83)

NOTE: Available with C, W-W4, Z, Z3 terminations only.

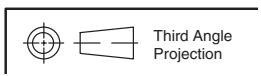

Dimensions are shown: Inches (mm)
Specifications and dimensions subject to change



www.ck-components.com



8020 Series Snap-acting Momentary Pushbutton Switches

Pushbutton
A

AVAILABLE HARDWARE

Cap

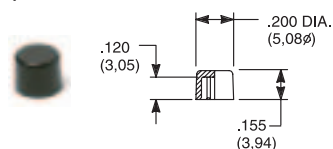

PART NO.

- 708901000 WHITE
- 708902000 BLACK
- 708903000 RED
- 708904000 ORANGE
- 708905000 YELLOW
- 708906000 GREEN
- 708907000 BLUE
- 708909000 GRAY

Material: Nylon
Finish: Gloss

Cap

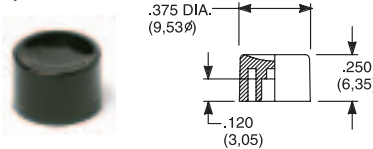

PART NO.

- 752701000 WHITE
- 752702000 BLACK
- 752703000 RED
- 752704000 ORANGE
- 752705000 YELLOW
- 752706000 GREEN
- 752707000 BLUE
- 752709000 GRAY

Material: Nylon
Finish: Gloss

Cap

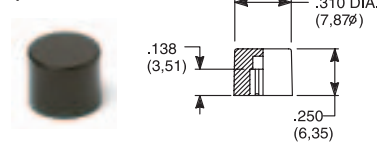

PART NO.

- 801801000 WHITE
- 801802000 BLACK
- 801803000 RED
- 801804000 ORANGE
- 801805000 YELLOW
- 801806000 GREEN
- 801807000 BLUE
- 801809000 GRAY

Material: Nylon
Finish: Gloss

Cap, Snap-fitting plunger

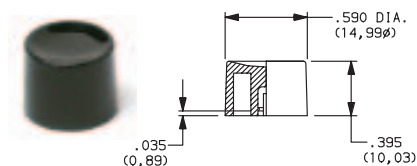

PART NO.

- 894001000 WHITE
- 894002000 BLACK
- 894003000 RED
- 894004000 ORANGE
- 894005000 YELLOW
- 894006000 GREEN
- 894007000 BLUE
- 894009000 GRAY

Material: Nylon
Finish: Gloss

Cap, Snap-fitting plunger

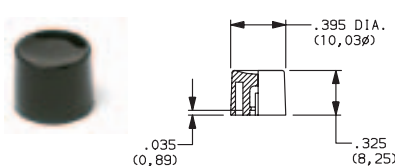

PART NO.

- 894101000 WHITE
- 894102000 BLACK
- 894103000 RED
- 894104000 ORANGE
- 894105000 YELLOW
- 894106000 GREEN
- 894107000 BLUE
- 894109000 GRAY

Material: Nylon
Finish: Gloss

Cap, J80, J81, J82, J83 & J84 options only

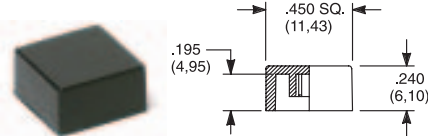

PART NO.

- 484601000 WHITE
- 484602000 BLACK
- 484603000 RED
- 484604000 ORANGE
- 484605000 YELLOW
- 484606000 GREEN
- 484607000 BLUE
- 484609000 GRAY

Material: Nylon
Finish: Gloss

PART NO.

- 798201000 WHITE
- 798202263 BLACK
- 798203000 RED
- 798204000 ORANGE
- 798205000 YELLOW
- 798206000 GREEN
- 798207000 BLUE
- 798209000 GRAY

Material: Nylon
Finish: Matte

Frame



PART NO.

- 615601000 WHITE
- 615602263 BLACK
- 615603000 RED
- 615605000 YELLOW
- 615606000 GREEN
- 615609000 GRAY

Material: Nylon
Finish: Matte

Frame



PART NO.

- 613301000 WHITE
- 613302263 BLACK
- 613303000 RED
- 613305000 YELLOW
- 613306000 GREEN
- 613309000 GRAY

Material: Nylon
Finish: Matte

Cap, J85 & J95 options only

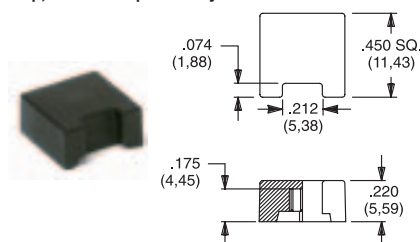

PART NO.

- 459701000 WHITE
- 459702000 BLACK
- 459703000 RED
- 459704000 ORANGE
- 459705000 YELLOW
- 459706000 GREEN
- 459707000 BLUE
- 459709000 GRAY

Material: Nylon
Finish: Gloss

PART NO.

- 476801000 WHITE
- 476802000 BLACK
- 476803000 RED
- 476804000 ORANGE
- 476805000 YELLOW
- 476806000 GREEN
- 476807000 BLUE
- 476809000 GRAY

Material: Nylon
Finish: Matte

Fits Z3 Termination
female connector



PART NO.

530100000

Available in loose pieces.

NOTE: Additional nuts, locking rings and lockwashers available separately, see section "Technical Data and Additional Hardware".

Other cap & frame colors available, consult Customer Service Center.

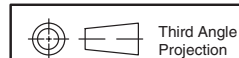

Dimensions are shown: Inches (mm)
Specifications and dimensions subject to change

www.ck-components.com

8020 Series Snap-acting Momentary Pushbutton Switches



AVAILABLE HARDWARE

Frames snap into panel opening and are independent from switch mounting. Accurate positioning of the PC mounted switch relative to the panel opening is necessary to provide proper clearance between actuator and frame. Available in two basic styles and four panel thicknesses .047-.125 in. Material: Nylon. Finish: Matte.

TYPICAL APPLICATION

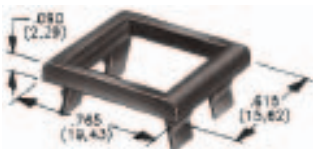
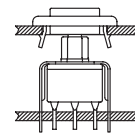

.047" (1,19) PANEL THK.	.062" (1,57) PANEL THK.	.090" (2,29) PANEL THK.	.125" (3,18) PANEL THK.
PART NO.	PART NO.	PART NO.	PART NO.
432501000	432601000	432701000	432801000
432502263	432602263	432702263	432802263
432503000	432603000	432703000	432803000
432505000	432605000	432705000	432805000
432506000	432606000	432706000	432806000
432509000	432609000	432709000	432809000
			WHITE
			BLACK
			RED
			YELLOW
			GREEN
			GRAY

PANEL MOUNTING

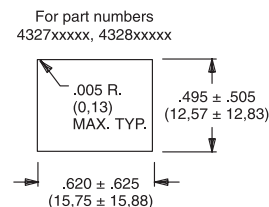
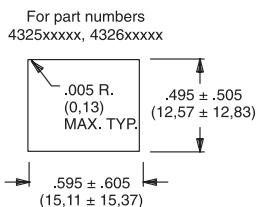

Panel Inserts

Above frames (part nos. 432XXXXXX) are also available with insert which accepts LED for indicator light assembly. Order insert separately from frame. Blank insert panel (without hole for LED) also available. **LED not included.**

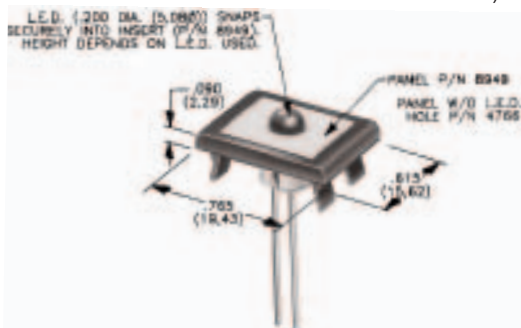

PANEL INSERT WITH HOLE FOR LED

PART NO.
894901000
894902000
894903000
894905000
894906000
894909000

BLANK PANEL INSERT WITHOUT HOLE FOR LED

PART NO.	
476601000	WHITE
476602000	BLACK
476603000	RED
476605000	YELLOW
476606000	GREEN
476609000	GRAY

Special colors, custom markings available, consult Customer Service Center.

LED INFORMATION

SWITCHES WITH LED SUPPLIED: J85, J95 OPTIONS:

Rectangular LEDs are supplied on 8020 Series pushbutton switches with J85 and J95 options. These LEDs are factory installed and are not replaceable. The following specifications apply:

OPTION CODE	COLOR	TYP. INTENSITY	TYP. FORWARD VOLTAGE	TYP. FORWARD CURRENT	MAX RATINGS AT 25°C AMBIENT TEMPERATURE		
					FORWARD VOLTAGE	CONTINUOUS FORWARD CURRENT	POWER DISSIPATION
6	Green	1.0 mcd	2.1 V	20 mA	2.5 V	50 mA	125 mW
3	Red*	0.5 mcd		10 mA		30 mA	75 mW
5	Yellow	4.0 mcd		20 mA		50 mA	125 mW

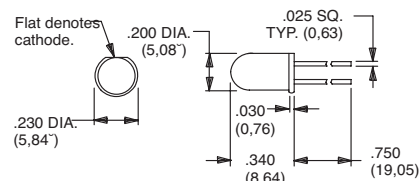

Suggested LED for J82 & J84 options. Dimensions for reference only.

Process Information: Soldering to LED leads must be completed within 5 seconds at 500°F (260°C) maximum.

Caution: Circuit elements must limit forward current of LED to 50mA max. continuous. * Extra-bright red LED available (typ. intensity 4.5 mcd), consult Customer Service Center. LEDs are not supplied with J82, J84 options. LED snaps into switch frame surrounding actuator and is wired externally.

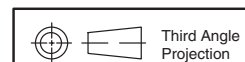

Dimensions are shown: Inches (mm)
Specifications and dimensions subject to change

