

General Specifications

Toggles

Rockers

Pushbuttons

Illuminated PB

Programmable

Keylocks

Rotaries

Slides

Tactiles

Tilt

Touch

Indicators

Accessories

Supplement

Electrical Capacity (Resistive Load)

- Power Level (silver):** 5A @ 125/250V AC or 5A @ 30V DC
Logic Level (gold): 0.4VA maximum @ 28V AC/DC maximum
 (Applicable Range 0.1mA ~ 0.1A @ 20mV ~ 28V)
 Note: Find additional explanation of operating range in Supplement section.

Other Ratings

- Contact Resistance:** 50 milliohms maximum for silver; 100 milliohms maximum for gold
Insulation Resistance: 200 megohms minimum @ 500V DC
Dielectric Strength: 1,000V AC minimum between contacts for 1 minute minimum;
 1,500V AC minimum between contacts & case for 1 minute minimum
Mechanical Life: 1,000,000 operations minimum for momentary;
 200,000 operations minimum for alternate action
Electrical Life: 10,000 operations minimum for silver;
 200,000 operations minimum for gold
Nominal Operating Force: Single Pole: 1.90N
 Double Pole: 2.55N
Contact Timing: Break before make
Travel: Pretravel .067" (1.7mm); Overtravel .024" (0.6mm); Total Travel .091" (2.3mm)

Materials & Finishes

- Housing/Bezel:** Glass fiber reinforced polyamide (UL94V-0)
Snap-in Frame: Stainless steel
Movable Contactor: Phosphor bronze
Movable Contacts: Silver alloy or copper with gold plating
Stationary Contacts: Silver alloy or copper with gold plating
Switch Terminals: Phosphor bronze with silver or gold plating
Lamp Terminals: Brass with tin plating
Base: Glass fiber reinforced liquid crystal polymer (UL94V-0)

Environmental Data

- Operating Temperature Range:** -25°C through +50°C (-13°F through +122°F) for Illuminated
 -25°C through +70°C (-13°F through +158°F) for Nonilluminated
Humidity: 90 ~ 95% humidity for 240 hours @ 40°C (104°F)
Vibration: 10 ~ 55Hz with peak-to-peak amplitude of 1.5mm traversing the frequency range & returning in 1 minute; 3 right angled directions for 2 hours
Shock: 50G (490m/s²) acceleration (tested in 6 right angled directions, with 5 shocks in each direction)

Installation

- Cap Installation Force:** 15.0N maximum downward force on cap

Processing

- Soldering:** Wave Soldering (PC version): See Profile A in Supplement section.
 Manual Soldering: See Profile A in Supplement section.
Cleaning: These devices are not process sealed. Hand clean locally using alcohol based solution.

Standards & Certifications

- Flammability Standards:** UL94V-0 housing/bezel & base
UL: File No. E44145
 All single & double pole models recognized at 5A @ 125/250V AC or 0.014A @ 28V DC.
 Add "/U" to end of part number to order UL mark on switch.
 Add "/CUL" to end of part number to order cULus mark on switch.

Distinctive Characteristics

Wide selection of illumination effects is achieved with single and bicolor, 1- or 6-element LEDs in flat, beveled, or sculptured caps.

Alternating legends (patent pending) in choice of sculptured or flat caps, combined with super bright bicolor LED.

Combination of PCB mountability and short body allows use in compact applications.

Small behind panel dimension for snap-in mounting in tight spaces.

Snap-acting contact mechanism provides sensitive actuation with audible feedback; quick-make, quick-break characteristic limits arcing and prolongs electrical life.

Latchdown mechanism, independent of switching mechanism, gives outstanding stability and reliability plus visible and tactile indication of circuit status.

Terminals are epoxy sealed to lock out flux, solvents, and other contaminants.

Momentary and alternate action circuits available in the same space-saving body size.

Matching indicators available.

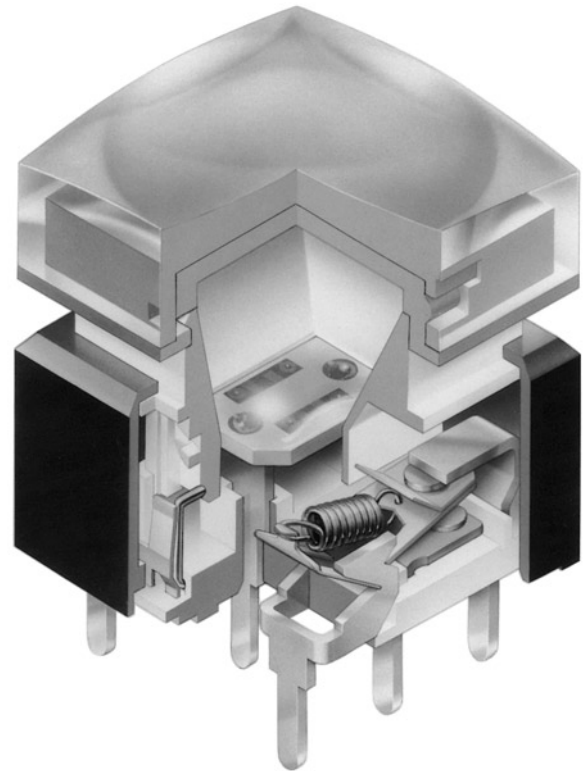

Actual Size

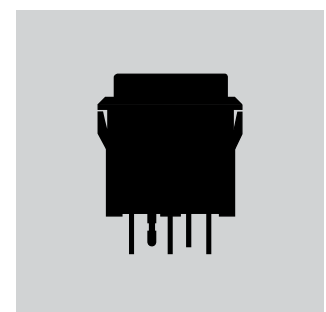

- Toggles
- Rockers
- Pushbuttons
- D Illuminated PB**
- Programmable
- Keylocks
- Rotaries
- Slides
- Tactiles
- Tilt
- Touch
- Indicators
- Accessories
- Supplement

Series UB2

Low Profile Pushbuttons

TYPICAL SWITCH ORDERING EXAMPLE

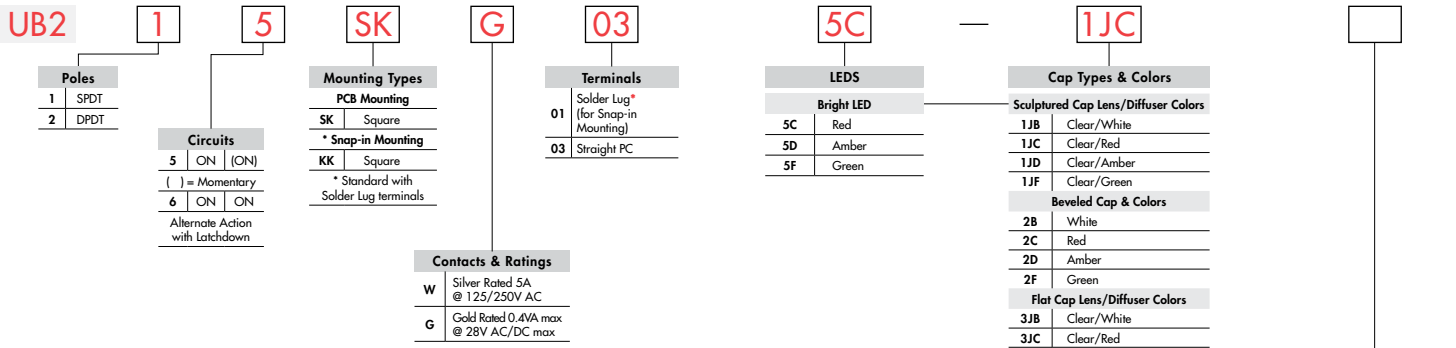

IMPORTANT:
Switches are supplied without UL & cULus marking unless specified. Specific models & ratings noted on General Specifications page.

* Wire harness & cable assemblies offered only in Americas

DESCRIPTION FOR TYPICAL ORDERING EXAMPLE UB215SKG035C-1JC

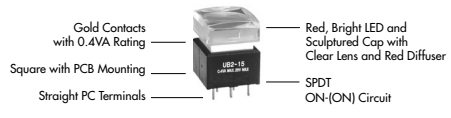

Super Bright LED	
6B	White
6F	Green
6G	Blue

Super Bright Bicolor LED	
6CF	Red/Green

Nonilluminated	
N	Nonilluminated

Sculptured Cap Lens/Diffuser Color	
1JB	Clear/White
Beveled Cap & Color	
2B	White
Flat Cap Lens/Diffuser Color	
3JB	Clear/White
Sculptured Cap with Alternating Legend	
4J	Clear Lens
Flat Cap with Alternating Legend	
5J	Clear Lens
Sculptured Cap Lens/Insert Colors	
4JA	Clear/Black
4JB	Clear/White
4JC	Clear/Red
4JD	Clear/Amber
4JF	Clear/Green
Beveled Cap & Colors	
5A	Black
5B	White
5D	Amber
5F	Green
5C	Red

Alternating Legends	
01	ON/OFF
02	START/STOP
04	OPEN/CLOSE

POLES & CIRCUITS

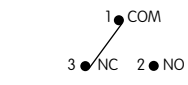
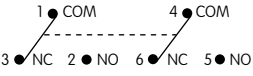
Pole	Model	Plunger Position () = Momentary		Connected Terminals		Throw & Switch/Lamp Schematics
		Normal	Down	Normal	Down	
SP	UB215 *UB216	ON ON	(ON) ON	1-3	1-2	Notes: Switch is marked with NC, NO, COM, L+ & L-. Lamp circuit is isolated and requires an external power source. 
DP	UB225 *UB226	ON ON	(ON) ON	1-3 4-6	1-2 4-5	

* When in latchdown position for the alternate circuit, cap positions above the housing are: .059" (1.5mm) for snap-in models & .276" (7.0mm) for PCB models.

MOUNTING TYPES & SHAPES

PCB Mounting



Square

SP, Single Color LED

DP, Single Color LED

SP, Bicolor LED

DP, Bicolor LED

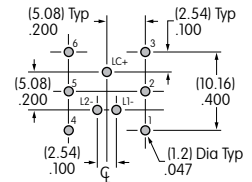
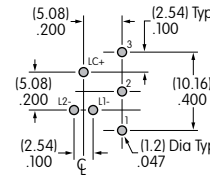
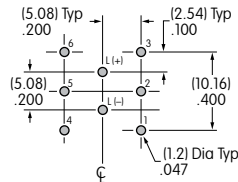
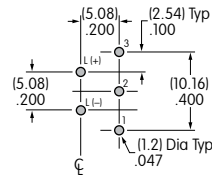
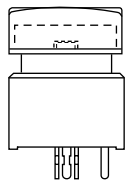

Snap-in Mounting (Solder Lug)



Square with Built-in Bezel

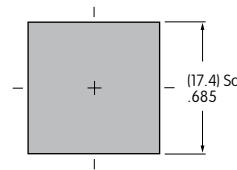
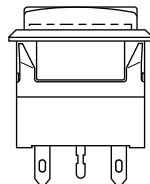

Panel Thickness:
.039 ~ .126"
(1.0 ~ 3.2mm)

CONTACT MATERIALS & RATINGS



Silver Contacts

Power Level

5A @ 125V AC & 250V AC



Gold Contacts

Logic Level

0.4VA maximum @ 28V AC/DC maximum

Complete explanation of operating range in Supplement section.

SWITCH & LAMP TERMINALS



Solder Lug

For Switch & Bright LED

For Super Bright & Bicolor LED



Straight PC

For Switch & Bright LED

For Super Bright & Bicolor LED

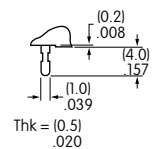
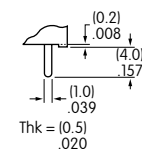
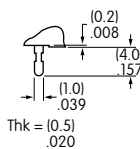
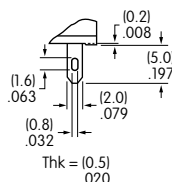

BRIGHT LED & CAPS

The electrical specifications shown are determined at a basic temperature of 25°C.
 LED circuit is isolated and requires an external power source. Polarity marks are on the bottom of the switch.
 If the source voltage exceeds the rated voltage, a ballast resistor is required.
 The resistor value can be calculated by using the formula in the Supplement section.

The LED is an integral part of the switch and not available separately.

Electrical Specifications for Bright LED

		5C	5D	5F	
	Color	Red	Amber	Green	Unit
Forward Peak Current	I_{FM}	30	30	25	mA
Continuous Forward Current	I_F	20	20	20	mA
Forward Voltage	V_F	1.85	2.0	2.1	V
Reverse Peak Voltage	V_{RM}	5	5	5	V
Current Reduction Rate Above 25°C	ΔI_F	0.40	0.42	0.46	mA/°C
Ambient Temperature Range		-25° ~ +50°			°C

Bright Single Color LED with 1 element

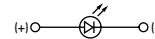

Caps for Bright LED

1 AT3074 Sculptured

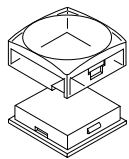
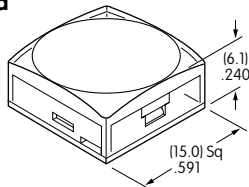

Clear Lens
 Translucent Colored Diffuser

2 AT3075 Beveled

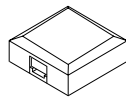
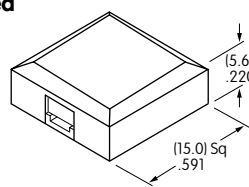

Translucent Colored Cap

3 AT3076 Flat

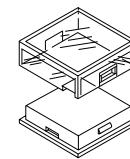
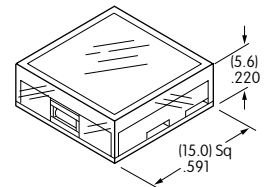

Clear Lens
 Translucent Colored Diffuser

Lens/Diffuser Colors Available:

- JB** Clear/White
- JC** Clear/Red
- JD** Clear/Amber
- JF** Clear/Green

Cap Colors Available:

- B** White
- C** Red
- D** Amber
- F** Green

Lens/Diffuser Colors Available:

- JB** Clear/White
- JC** Clear/Red
- JD** Clear/Amber
- JF** Clear/Green

Material: Polycarbonate

Finish: Glossy

SUPER BRIGHT LEDs & CAPS

The electrical specifications shown are determined at a basic temperature of 25°C.
LED circuit is isolated and requires an external power source. Polarity marks are on the bottom of the switch.

If the source voltage exceeds the rated voltage, a ballast resistor is required.
The resistor value can be calculated by using the formula in the Supplement section.

The LED is an integral part of the switch and not available separately.

Electrical Specifications for Super Bright LEDs

Super Bright LEDs are Electrostatic Sensitive		Color	6B White	6F Green	6G Blue	Unit
Forward Peak Current		I_{FM}	25	25	25	mA
Continuous Forward Current		I_F	20	20	20	mA
Forward Voltage		V_F	3.6	3.5	3.6	V
Reverse Peak Voltage		V_{RM}	5	5	5	V
Current Reduction Rate Above 25°C		ΔI_F	0.40	0.40	0.40	mA/°C
Ambient Temperature Range			-25° ~ +50°			°C

Super Bright Single Color LED with 1 element

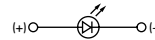

Caps for Super Bright LED

1JB AT3074JB Sculptured Clear Lens/White Diffuser

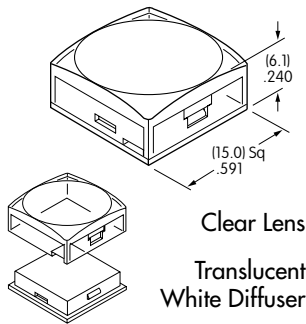

2B AT3075B Beveled White Cap

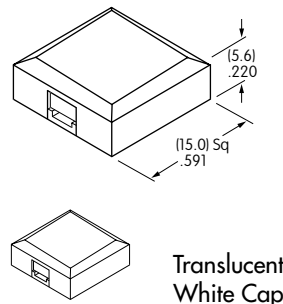

3JB AT3076JB Flat Clear Lens/White Diffuser

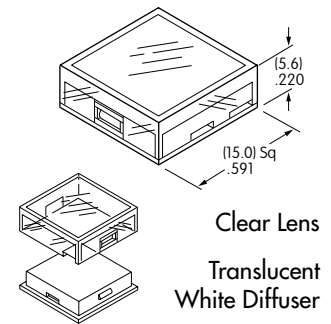

Material: Polycarbonate Finish: Glossy

SUPER BRIGHT BICOLOR LED & CAPS

Electrical Specifications for Super Bright Bicolor LED

<p>The electrical specifications shown are determined at a basic temperature of 25°C. LED circuit is isolated and requires an external power source. Polarity marks are on bottom of switch. If the source voltage exceeds the rated voltage, a ballast resistor is required. The resistor value can be calculated by using the formula in Supplement Section. The LED is an integral part of the switch and not available separately.</p>	Super Bright LEDs are Electrostatic Sensitive		Color	6CF Red/Green	Unit
	Forward Peak Current		I_{FM}	30/25 (25/22 for Amber)	mA
	Continuous Forward Current		I_F	20/20	mA
	Forward Voltage		V_F	2.1/3.5	V
	Reverse Peak Voltage		V_{RM}	4/4	V
	Current Reduction Rate Above 25°C		ΔI_F	0.40/0.33	mA/°C
	Ambient Temperature Range			-25° ~ +50°	°C

Super Bright Bicolor LED with 2 elements

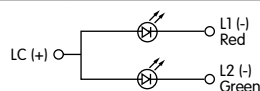

Amber color is achieved by lighting red and green simultaneously, but is not suitable for Alternating Legends.

Caps for Super Bright Bicolor LED

1JB

AT3074JB Sculptured Clear Lens/White Diffuser

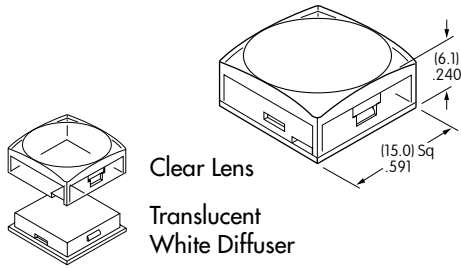

2B

AT3075B Beveled White Cap

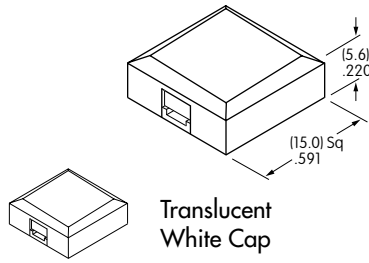

3JB

AT3076JB Flat Clear Lens/White Diffuser

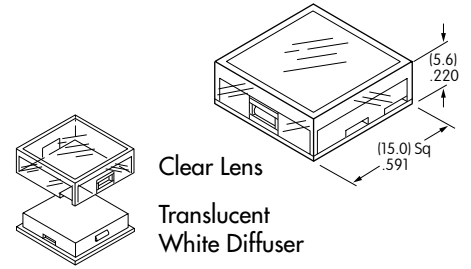

Material: Polycarbonate Finish: Glossy

Alternating Legend Caps for Super Bright Bicolor LED

4J

AT3069J Sculptured Cap with Alternating Legend

Clear Lens
Alternating Legend Filter

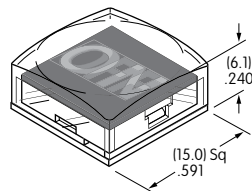

5J

AT3070J Flat Cap with Alternating Legend

Clear Lens
Alternating Legend Filter

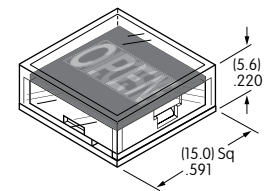

Material: Polycarbonate Finish: Glossy

Standard Alternating Legend Pairs

01

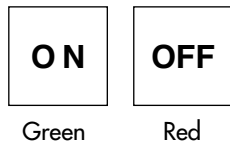

02

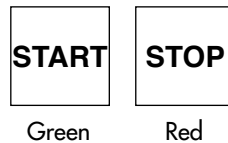

04

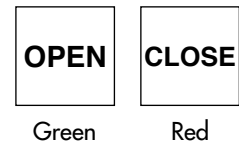

Cap illumination is alternating green/red; legend text is black.
Contact factory for other Alternating Legends.

Legend illustrations are approximate representations of the actual characters on the filters.

No Code

No Lamp

CAP TYPES & COLOR COMBINATIONS FOR NONILLUMINATED

4

AT3073 Sculptured

Lens/Insert
Colors Available:

JA

Clear/Black

JB

Clear/White

JC

Clear/Red

JD

Clear/Amber

JF

Clear/Green

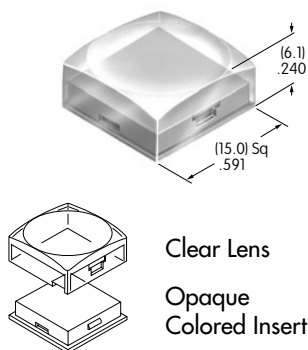

Material: Polycarbonate
Finish: Glossy

5

AT3077 Beveled

Cap
Colors Available:

A

Black

B

White

C

Red

D

Amber

F

Green

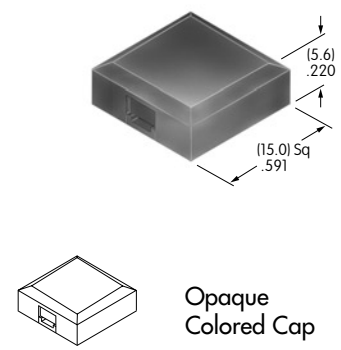

Material: Polycarbonate
Finish: Glossy

TYPICAL SWITCH DIMENSIONS

Bright & Super Bright LED Straight PC

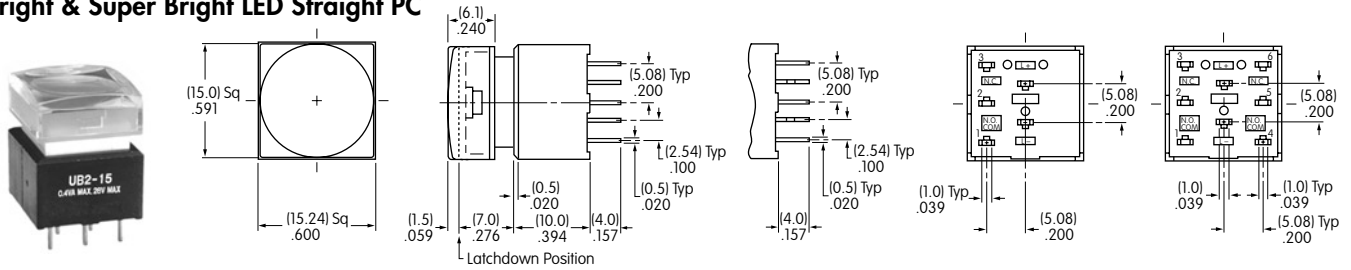

UB215SKG035C-1JC

Bright Single Color LED

Super Bright Single Color LED

Single Pole

Double Pole

Bicolor LED Straight PC

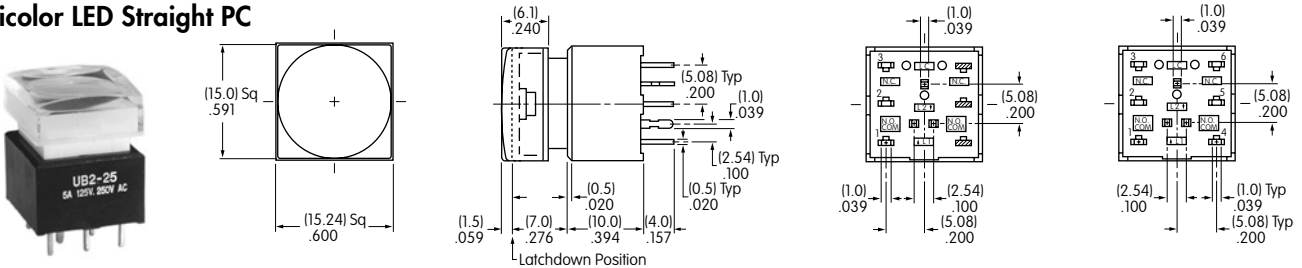

UB225SKG03CF-1JB

Bicolor LED Side View

Single Pole

Double Pole

Bright LED Solder Lug

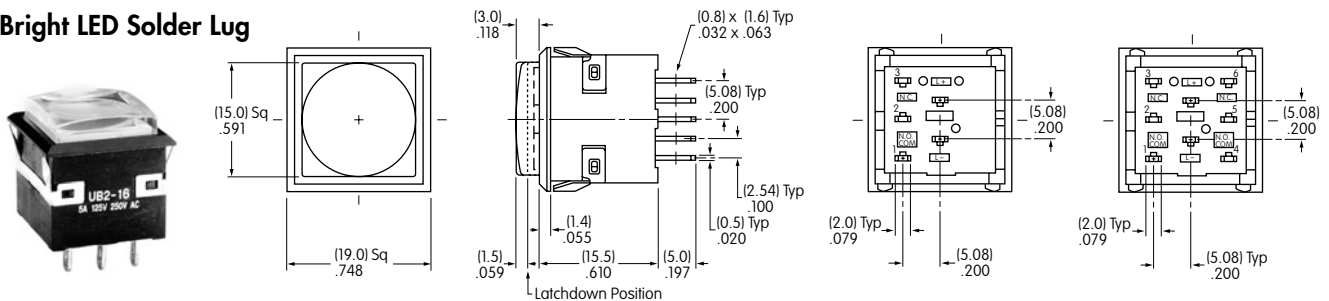

UB216KKW015F-1JF

Single Color LED Side View

Single Pole

Double Pole

Super Bright LED Solder Lug

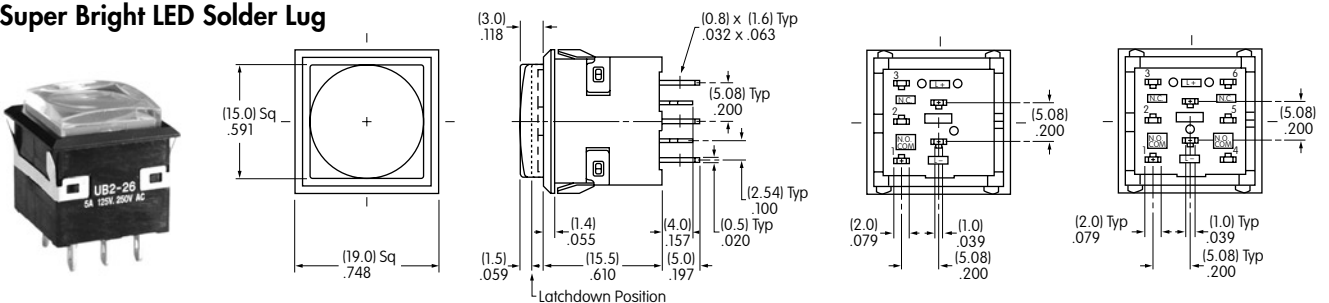

UB226KKW016F-1JF

Single Color LED Side View

Single Pole

Double Pole

Bicolor LED Solder Lug

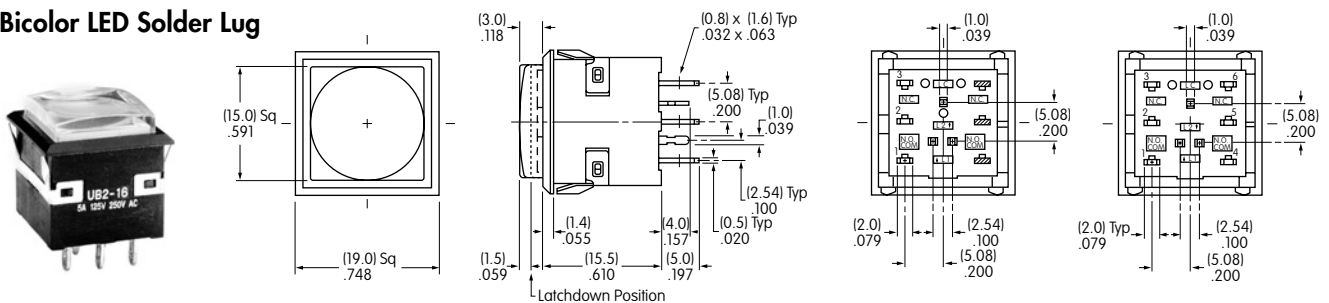

UB216KKW01CF-1JB

Bicolor LED Side View

Single Pole

Double Pole

OPTIONAL ACCESSORIES

Protective Guard for Snap-in Model

AT4141

Opens 90°
Closes manually

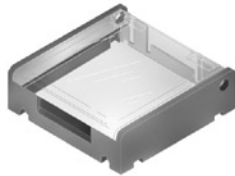

Materials:

Cover: Clear Polycarbonate
Base: Black GFR Polyamide

Recommended Panel Thickness:

.039" ~ .106" (1.0mm ~ 2.7mm)

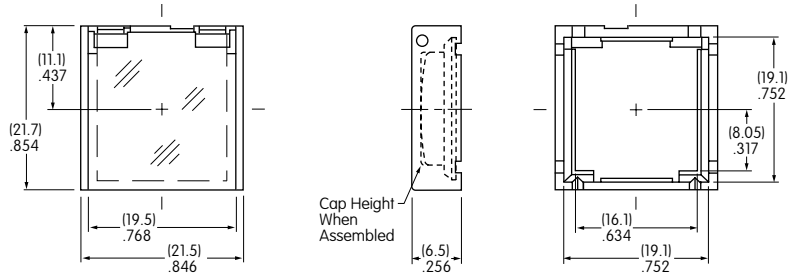

Spring Loaded Protective Guard for Snap-in Mounting of PCB Model

AT4170

Opens 180°
Closes automatically



Materials:

Cover: Clear Polycarbonate
Base: Black Polyamide
Coil Spring: Stainless Steel

Recommended Panel Thickness:

.039" ~ .126"
(1.0mm ~ 3.2mm)

Recommended Panel-to-PCB Range:

.531" ~ .622"
(13.5mm ~ 15.8mm)

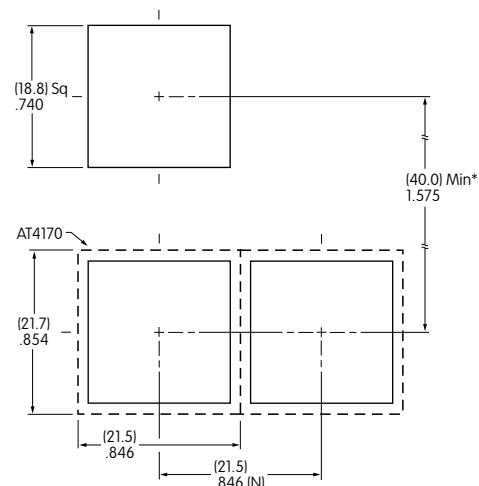
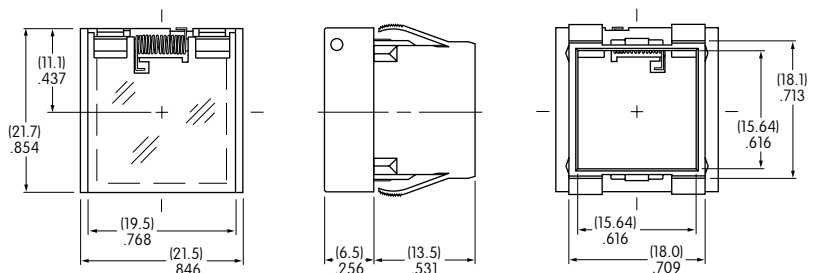

(N) = Number of switches

* Minimum dimension allows opening of cover to 180°

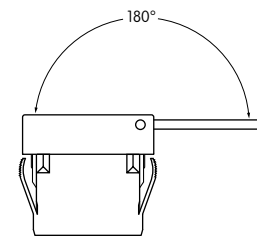
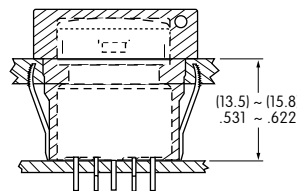

Installation

- ① Install switch onto PC board.
- ② Snap protective guard into panel.
- ③ Join the two assemblies.

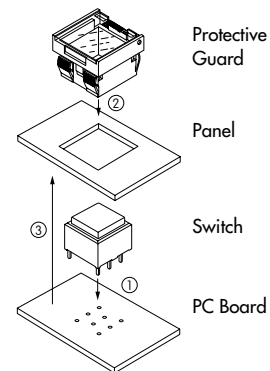

OPTIONAL ACCESSORIES

Spring Loaded Protective Guard for Snap-in Model

AT4142

Opens 180°
Closes automatically

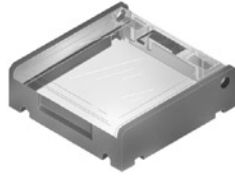

Materials:

Cover: Clear Polycarbonate
Base: Black GFR Polyamide
Coil Spring: Stainless Steel

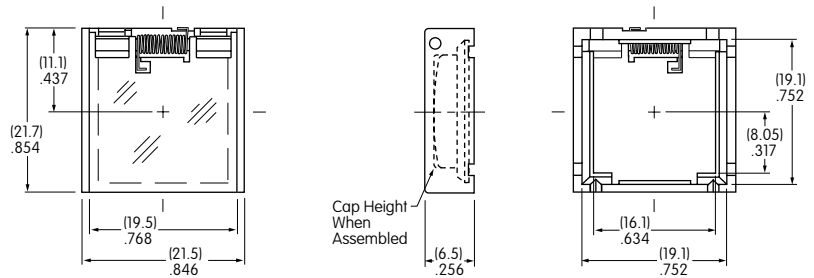

Recommended Panel Thickness:

.039" ~ .106" (1.0mm ~ 2.7mm)

Dust Cover

AT4145 Not for use with barriers.

Materials:

Lid: Clear PVC
Operating temperature range:
0°C ~ +70°C (32°F ~ 158°C).
Gasket: Polyethylene

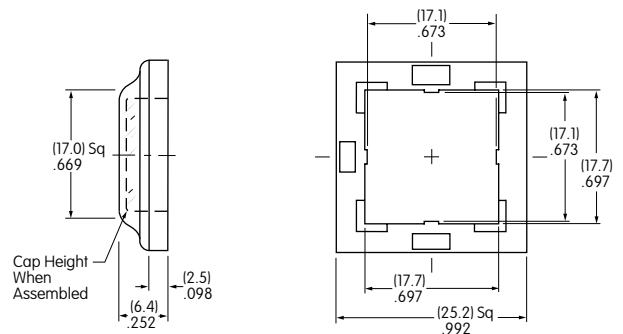
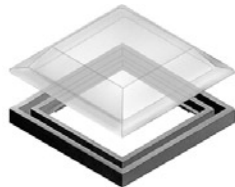

Recommended Panel Thickness

.039" ~ .098" (1.0mm ~ 2.5mm)

Barriers for Snap-in Mount

AT4143 End

AT4144 Center

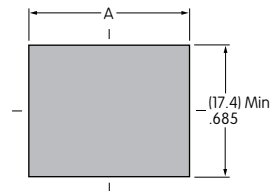
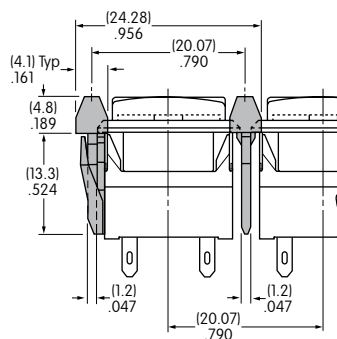
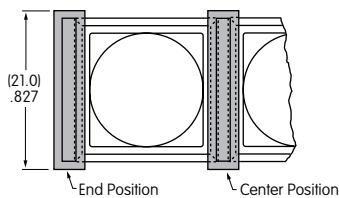

Cutouts for more than 1 Switch:

$$A = .799" (20.3\text{mm}) \times \text{Number of Switches} + .051" (1.3\text{mm})$$

Material: Polyamide

LEGENDS

NKK Switches can provide custom legends for caps. Contact factory for more information.

Suggested Printable Area for UB2 Lens, Film Insert or Diffuser

Recommended Methods: Laser Etch on clear lens, Screen Print or Pad Print on lens;
Laser Print on film insert.

Shaded areas are printable areas.

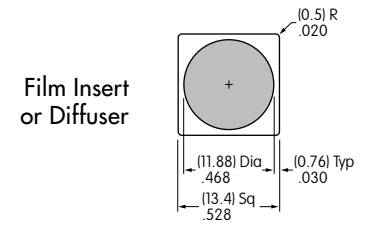
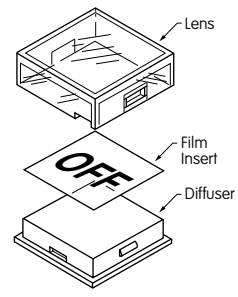
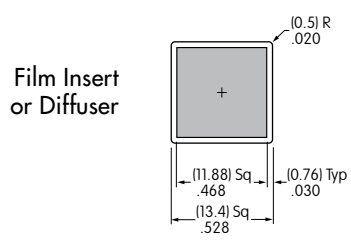
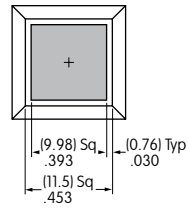
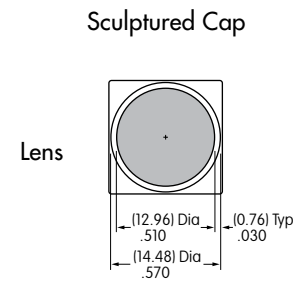
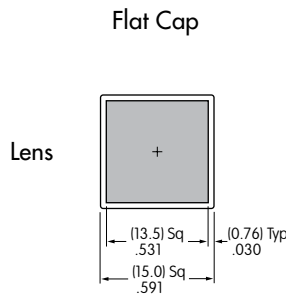
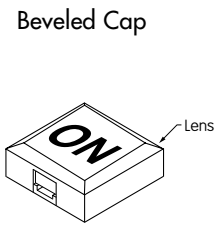

Film Insert: Clear Polyester 4 mil maximum thickness

- Toggles
- Rockers
- Pushbuttons
- Illuminated PB**
- Programmable
- Keylocks
- Rotaries
- Slides
- Tactiles
- Tilt
- Touch
- Indicators
- Accessories
- Supplement