

Subminiature Reflective Optical Sensor with Phototransistor Output

Description

The TCNT1000 has a compact construction where the emitting-light source and the detector are arranged in the same direction to sense the presence of an object by using the reflective IR-beam from the object. The operating wavelength is 950 nm. The detector consists of a phototransistor.

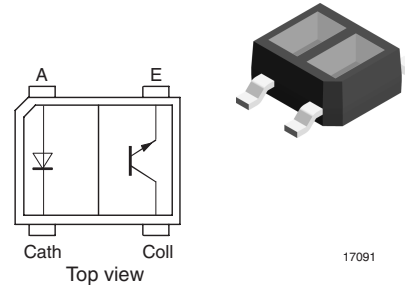

Features

- Package height: 1.5 mm
- Parts shipped taped and reeled 1000 pcs/ reel
- Soldering method according to CECC00802 table 1, class B or C
- Surface Mountable Technology (SMD)
- Lead-free component
- Component in accordance to RoHS 2002/95/EC and WEEE 2002/96/EC

Applications

- Accurate position sensor for shaft encoder
- Detection of reflective material such as paper, IBM cards, magnetic tapes etc.
- Suitable for copy machines, printers, fax machines

Parts Table

Part	Sensing Distance
TCNT1000	1 mm

Absolute Maximum Ratings

Coupler

Parameter	Test condition	Symbol	Value	Unit
Ambient temperature range		T_{amb}	- 40 to + 85	°C
Storage temperature range		T_{stg}	- 40 to + 90	°C
Soldering temperature	$t \leq 5$ s	$T_{sd}^{1)}$	260	°C

¹⁾ 1.6 mm distance from Body

Input (Emitter)

Parameter	Test condition	Symbol	Value	Unit
Reverse voltage		V_R	5	V
Forward current		I_F	50	mA
Pulse forward current	$t_p = 0.1$ ms; duty cycle = 1%	I_{FP}	1	A
Power dissipation		P_V	75	mW

Output (Detector)

Parameter	Test condition	Symbol	Value	Unit
Collector emitter voltage		V_{CEO}	30	V
Emitter collector voltage		V_{ECO}	5	V
Collector current		I_C	50	mA
Power dissipation		P_V	75	mW

Electrical Characteristics

Coupler

$T_{amb} = 25\text{ }^\circ\text{C}$, unless otherwise specified

Parameter	Test condition	Symbol	Min	Typ.	Max	Unit
Collector current	$V_{CE} = 5\text{ V}$, $I_F = 20\text{ mA}$	$I_C^{(1)}$	100			μA
Rise time	$V_S = 2\text{ V}$, $I_C = 0.1\text{ mA}$, $R_L = 1\text{ k}\Omega$	t_r		20		μs
Fall time	$V_S = 2\text{ V}$, $I_C = 0.1\text{ mA}$, $R_L = 1\text{ k}\Omega$	t_f		20		μs

¹⁾ Working distance to object: $d = 1\text{ mm}$; object: Flat mirror (see figure 1)

Input (Emitter)

Parameter	Test condition	Symbol	Min	Typ.	Max	Unit
Forward voltage	$I_F = 20\text{ mA}$	V_F		1.2	1.6	V
Reverse current	$V_R = 5\text{ V}$	I_R			10	μA

Output (Detector)

Parameter	Test condition	Symbol	Min	Typ.	Max	Unit
Collector emitter voltage	$I_C = 1\text{ mA}$	V_{CEO}	30			V
Emitter collector voltage	$I_E = 100\text{ }\mu\text{A}$	V_{ECO}	5			V
Collector-emitter cut-off current	$V_{CE} = 20\text{ V}$, $I_F = 0$, $E = 0$	I_{CEO}			100	nA
Cross talk current	$V_{CE} = 5\text{ V}$, $I_F = 10\text{ mA}$	$I_{CX}^{(2)}$			200	nA

²⁾ Without reflecting medium

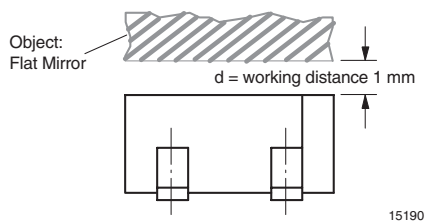

Figure 1. Pulse diagram

Typical Characteristics ($T_{amb} = 25\text{ }^{\circ}\text{C}$ unless otherwise specified)

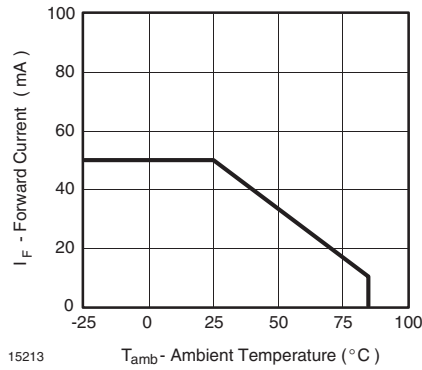

Figure 2. Forward Current vs. Ambient Temperature

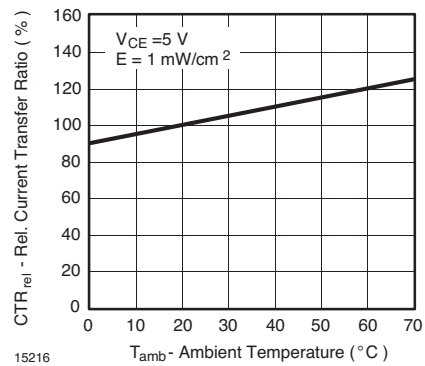

Figure 5. Relative Current Transfer Ratio vs. Ambient Temperature

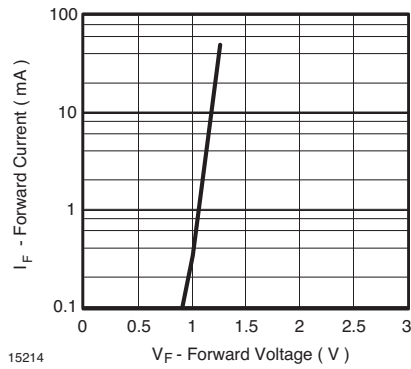

Figure 3. Forward Current vs. Forward Voltage

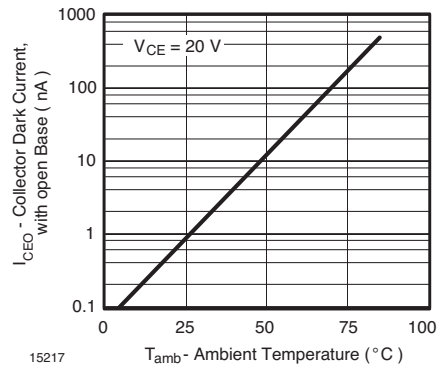

Figure 6. Collector Dark Current vs. Ambient Temperature

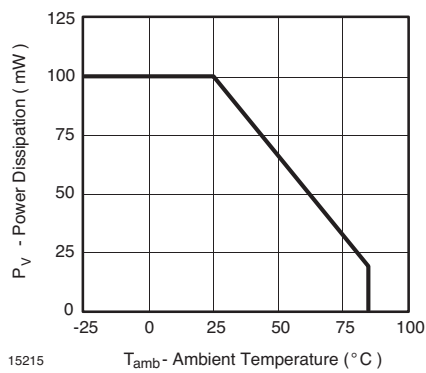

Figure 4. Power Dissipation vs. Ambient Temperature

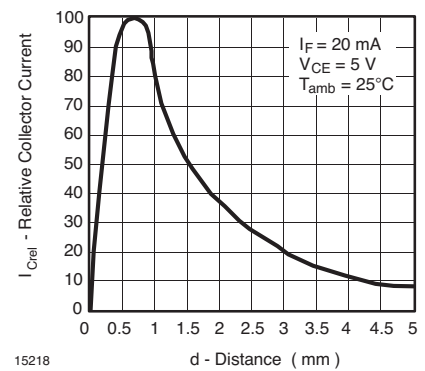

Figure 7. Relative Collector vs. Distance

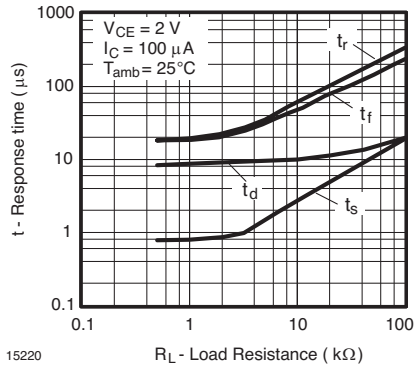

Figure 8. Response Time vs. Load Resistance

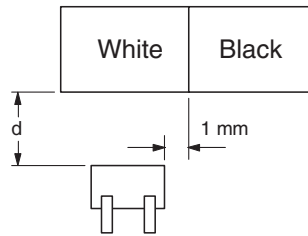
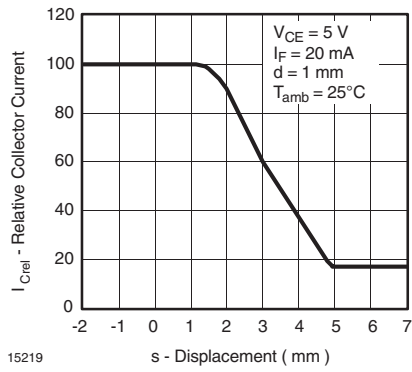
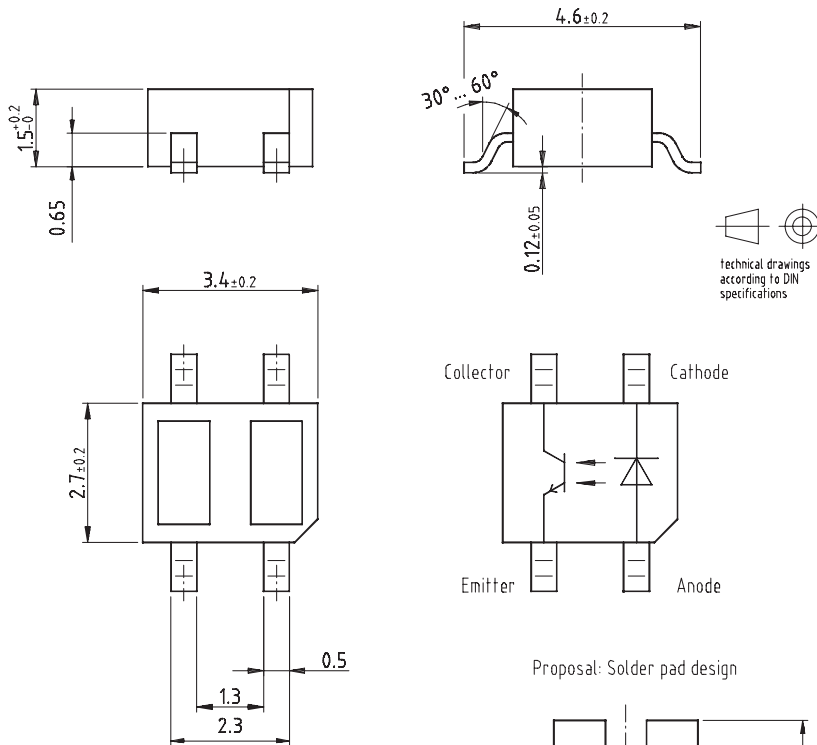

Figure 9. Relative Collector Current vs. Displacement

Package Dimensions in mm



Drawing-No: 6.541-5045.01-4
 Issue: 3; 07.02.01

15191

Dimensions of Shape in mm

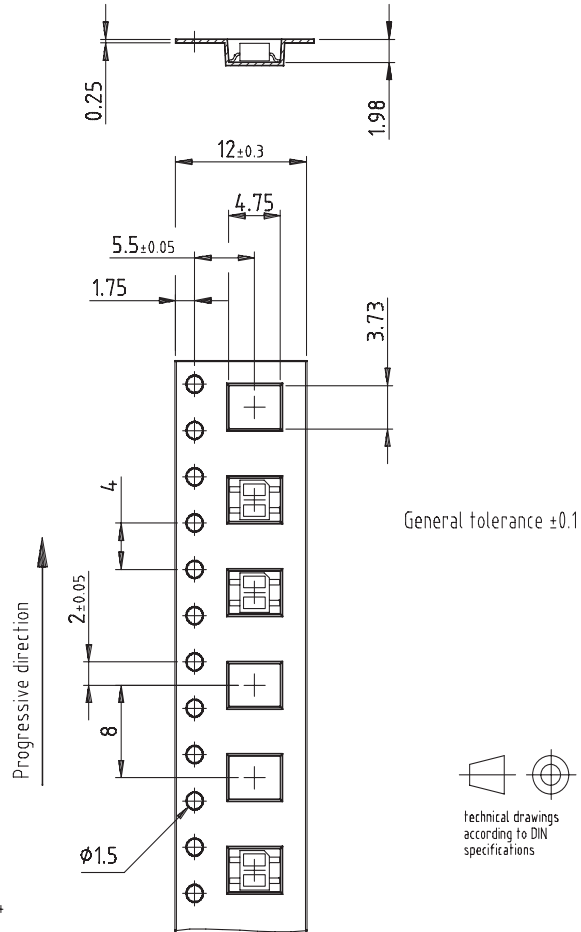

Drawing-No.: 9.700-5249.01-4

Issue: 1; 11.05.00

15211

Ozone Depleting Substances Policy Statement

It is the policy of **Vishay Semiconductor GmbH** to

1. Meet all present and future national and international statutory requirements.
2. Regularly and continuously improve the performance of our products, processes, distribution and operating systems with respect to their impact on the health and safety of our employees and the public, as well as their impact on the environment.

It is particular concern to control or eliminate releases of those substances into the atmosphere which are known as ozone depleting substances (ODSs).

The Montreal Protocol (1987) and its London Amendments (1990) intend to severely restrict the use of ODSs and forbid their use within the next ten years. Various national and international initiatives are pressing for an earlier ban on these substances.

Vishay Semiconductor GmbH has been able to use its policy of continuous improvements to eliminate the use of ODSs listed in the following documents.

1. Annex A, B and list of transitional substances of the Montreal Protocol and the London Amendments respectively
2. Class I and II ozone depleting substances in the Clean Air Act Amendments of 1990 by the Environmental Protection Agency (EPA) in the USA
3. Council Decision 88/540/EEC and 91/690/EEC Annex A, B and C (transitional substances) respectively.

Vishay Semiconductor GmbH can certify that our semiconductors are not manufactured with ozone depleting substances and do not contain such substances.

**We reserve the right to make changes to improve technical design
and may do so without further notice.**

Parameters can vary in different applications. All operating parameters must be validated for each customer application by the customer. Should the buyer use Vishay Semiconductors products for any unintended or unauthorized application, the buyer shall indemnify Vishay Semiconductors against all claims, costs, damages, and expenses, arising out of, directly or indirectly, any claim of personal damage, injury or death associated with such unintended or unauthorized use.

Vishay Semiconductor GmbH, P.O.B. 3535, D-74025 Heilbronn, Germany
Telephone: 49 (0)7131 67 2831, Fax number: 49 (0)7131 67 2423



Notice

Specifications of the products displayed herein are subject to change without notice. Vishay Intertechnology, Inc., or anyone on its behalf, assumes no responsibility or liability for any errors or inaccuracies.

Information contained herein is intended to provide a product description only. No license, express or implied, by estoppel or otherwise, to any intellectual property rights is granted by this document. Except as provided in Vishay's terms and conditions of sale for such products, Vishay assumes no liability whatsoever, and disclaims any express or implied warranty, relating to sale and/or use of Vishay products including liability or warranties relating to fitness for a particular purpose, merchantability, or infringement of any patent, copyright, or other intellectual property right.

The products shown herein are not designed for use in medical, life-saving, or life-sustaining applications. Customers using or selling these products for use in such applications do so at their own risk and agree to fully indemnify Vishay for any damages resulting from such improper use or sale.