

Distinctive Characteristics

Fully illuminated toggle for highly visible status indication with LED in red, green, or amber for single color and red/green for bicolor.

Ultra-miniature size allows high density mounting, and extremely light weight makes these switches ideal for handheld equipment.

Totally sealed body construction prevents contact contamination and allows time- and money-saving automated soldering and cleaning.

Molded-in, epoxy sealed terminals lock out flux, solvents, and other contaminants.

Award-winning STC contact mechanism with benefits unavailable in conventional mechanisms: smooth, positive detent actuation, increased contact stability, and unparalleled logic-level reliability. (Additional STC details in Terms & Acronyms; see Supplement section.)

.100" x .100" (2.54mm x 2.54mm) terminal spacing conforms to standard PC board grid spacing. Round terminals facilitate easier through-hole mounting on PC boards.

Nonilluminated toggles available and shown in the Toggle section.

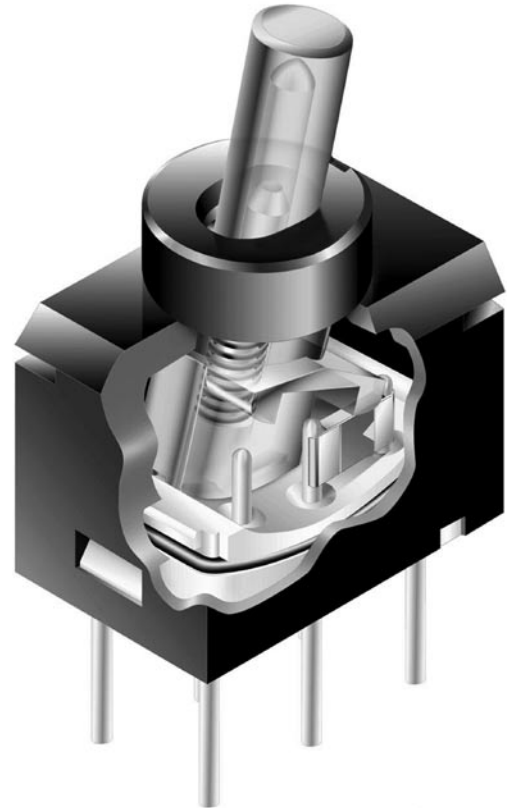

Actual Size

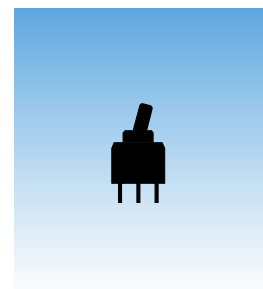

General Specifications

Electrical Capacity (Resistive Load)

Logic Level: 0.4VA maximum @ 28V AC/DC maximum
 (Applicable Range 0.1mA ~ 0.1A @ 20mV ~ 28V)
 Note: Find additional explanation of operating range in Supplement section.

Other Ratings

Contact Resistance: 80 milliohms maximum
Insulation Resistance: 500 megohms minimum @ 500V DC
Dielectric Strength: 500V AC minimum for 1 minute minimum
Mechanical Life: 100,000 operations minimum
Electrical Life: 100,000 operations minimum
 10,000 operations minimum @ 0.1A @ 28V AC/DC
Nominal Operating Force: 1.30N
Angle of Throw: 28°

Materials & Finishes

Actuator: Polyamide
Case: Glass fiber reinforced polyamide
Sealing Rings: Nitrile butadiene rubber
Movable Contacts: Phosphor bronze with gold plating
Stationary Contacts: Phosphor bronze with gold plating
Base: Glass fiber reinforced polyamide
Power Terminals: Phosphor bronze with gold plating
Lamp Terminals: Phosphor bronze with gold plating

Environmental Data

Operating Temperature Range: -25°C through +55°C (-13°F through +131°F)
Humidity: 90 ~ 95% humidity for 240 hours @ 40°C (104°F)
Vibration: 10 ~ 500Hz with peak-to-peak amplitude of 1.5mm traversing the frequency range & returning in 1 minute; 3 right angled directions for 2 hours
Shock: 50G (490m/s²) acceleration (tested in 6 right angled directions, with 5 shocks in each direction)

PCB Processing

Soldering: Wave Soldering recommended. See Profile A in Supplement section.
 Manual Soldering: See Profile A in Supplement section.
Cleaning: Automated cleaning. See Cleaning specifications in Supplement section.

Standards & Certifications

UL Recognition or CSA Certification: The G Series toggles have not been tested for UL recognition or CSA certification. These switches are designed for use in a low-voltage, low-current, logic-level circuit. When used as intended in a logic-level circuit, the results do not produce hazardous energy.

TYPICAL SWITCH ORDERING EXAMPLE

G	1	2	J	H	C
POLE	CIRCUITS			ACTUATOR	PC TERMINALS
1 SPDT	2 ON NONE ON	Clear			P Straight
	Combines with single color or bicolor LEDs				H Right Angle
	3 ON OFF ON	Right Angle PC Terminals			V Vertical
	Combines with bicolor LED only				
	LEDS				
	Single Color				
	C	Red			
	D	Amber			
	F	Green			
	ON-NONE-ON only				
	Bicolor				
	CF	Red/Green			
	ON-NONE-ON & ON-OFF-ON				

DESCRIPTION FOR TYPICAL ORDERING EXAMPLE
G12JHC

POLES & CIRCUITS

Pole Throw	Model	Toggle Position			Connected Terminals			Schematics
		Up	Center	Down	Up	Center	Down	
SPDT	G12 G13	ON	NONE	ON	2-3	NONE	2-1	Note: Terminal numbers are not actually on the switch. LED circuit is isolated and requires an external power source. Single Color
		ON	OFF	ON	2-3	OPEN	2-1	

ACTUATOR

J Clear Toggle

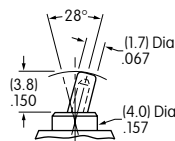

LED COLORS & SPECIFICATIONS

LEDs are an integral part of the switch and not available separately. The electrical specifications shown are determined at a basic temperature of 25°C.

If the source voltage exceeds the rated voltage, a ballast resistor is required.

The resistor value can be calculated by using the formula in the Supplement; see Supplement Index.

	Colors	Single Color			Bicolor
		C Red	D Amber	F Green	CF Red/Green
Forward Peak Current	I_{FM}	25mA	25mA	25mA	25mA/25mA
Continuous Forward Current	I_F	20mA	20mA	20mA	20mA/20mA
Forward Voltage	V_F	2.0V	2.1V	2.1V	2.0V/2.1V
Reverse Peak Voltage	V_{RM}	4V	4V	4V	4V/4V
Current Reduction Rate Above 25°C	ΔI_F	0.33mA/°C			
Ambient Temperature Range		-25° ~ +55°C			

PC TERMINALS

P

Straight

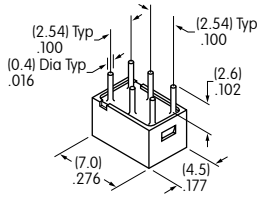

H

Right Angle

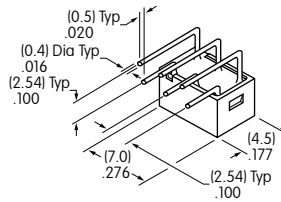

V

Vertical

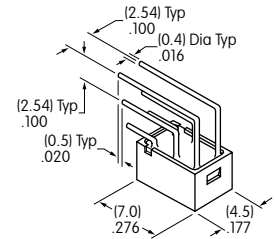

TYPICAL SWITCH DIMENSIONS

Straight PC

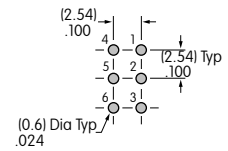
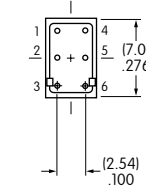
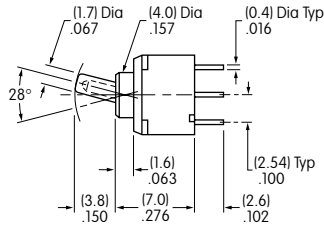
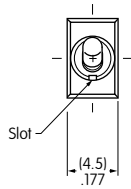

G12JP

5 & 6 are LED terminals; 4 is a support pin on single color models & an LED terminal on bicolor models.

Right Angle PC

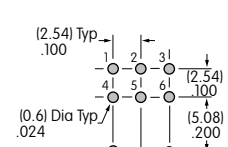
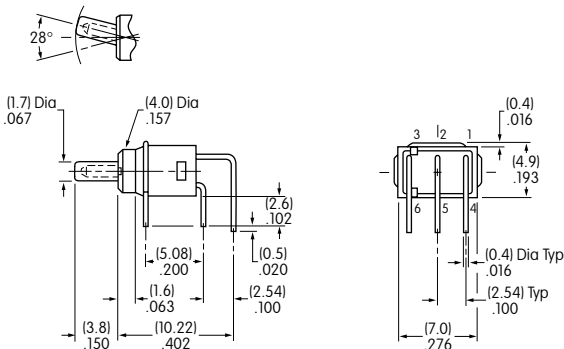
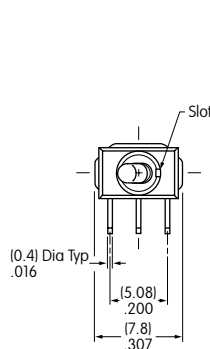

G12JHD

5 & 6 are LED terminals; 4 is a support pin on single color models & an LED terminal on bicolor models.

Vertical PC

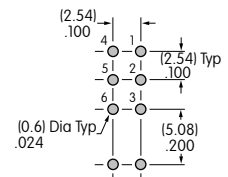
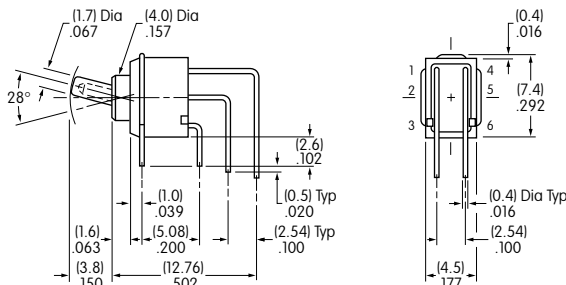
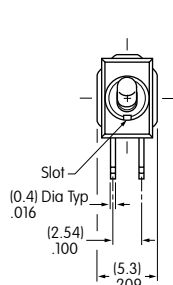
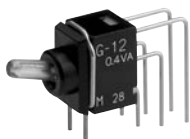

G12JVCF

5 & 6 are LED terminals; 4 is a support pin on single color models & an LED terminal on bicolor models.