

### Specifications Common to All

### A22/M22

The Following Pages Provide Information Common To Each Model of The A22/M22 Pushbutton Switch

- A22
- A22S/W
- A22K
- M22

## Specifications

### ■ APPROVED STANDARDS

| Recognized organization | Standards   | File No. |
|-------------------------|-------------|----------|
| UL, cUL (See note)      | UL508       | E41515   |
| ASTA                    | EN60947-5-1 | —        |

Note: UL: CSA C22 No. 14

### ■ RATINGS

#### Contacts (General-purpose Load)

| Rated carry current | Rated voltage | Rated current (A)     |                       |                       |                       |
|---------------------|---------------|-----------------------|-----------------------|-----------------------|-----------------------|
|                     |               | Utilization category  |                       |                       |                       |
|                     |               | AC15 (inductive load) | AC12 (resistive load) | DC13 (inductive load) | DC12 (resistive load) |
| 10 amps             | 24 VAC        | 10                    | 10                    | —                     | —                     |
|                     | 110 VAC       | 5                     | 10                    | —                     | —                     |
|                     | 220 VAC       | 3                     | 6                     | —                     | —                     |
|                     | 380 VAC       | 2                     | 3                     | —                     | —                     |
|                     | 440 VAC       | 1                     | 2                     | —                     | —                     |
|                     | 24 VDC        | —                     | —                     | 1.5                   | 10                    |
|                     | 110 VDC       | —                     | —                     | 0.5                   | 2                     |
|                     | 220 VDC       | —                     | —                     | 0.2                   | 0.6                   |
| 380 VDC             | —             | —                     | 0.1                   | 0.2                   |                       |

Note: 1. Rated current values are determined according to the testing conditions specified by JIS C4520. The above ratings were obtained by conducting tests under the following conditions as specified by JIS C4505.

- (1) Ambient temperature: 20°±2°C
- (2) Ambient humidity: 65±5%
- (3) Operating frequency: 20 operations/min

2. Minimum applied load: 10 mA, 5 VDC

#### Contacts (Microload)

| Rated applied load            | Minimum applied load |
|-------------------------------|----------------------|
| 50 mA, 5 VDC (Resistive load) | 1 mA, 5 VDC          |

#### LED Indicators without Transformer

| Rated voltage | Rated current | Operating voltage |
|---------------|---------------|-------------------|
| 6 VDC         | 60 mA         | 6 VDC±5%          |
| 6 VAC         | 60 mA         | 6 VAC/DC±5%       |
| 12 VAC/DC     | 30 mA         | 12 VAC/DC±5%      |
| 24 VAC/DC     | 15 mA         | 24 VAC/DC±5%      |

**Incandescent Lamp**

| Rated voltage | Rated current | Operating voltage |
|---------------|---------------|-------------------|
| 6 VDC         | 200 mA        | 5 V               |
| 14 VAC/DC     | 80 mA         | 12 V              |
| 28 VAC/DC     | 40 mA         | 24 V              |
| 130 VAC/DC    | 20 mA         | 100 V             |

**Transformer Lighting**

| Rated voltage | Operational voltage | Applicable lamp (BA8S/13□ gold) |
|---------------|---------------------|---------------------------------|
| 110 VAC       | 95 to 115 VAC       | LED Lamp (A22-24A□)             |
| 220 VAC       | 190 to 230 VAC      |                                 |

**■ CHARACTERISTICS**

| Item                              |                          | Pushbutton switches   |   | Emergency stop switches   |   | Knob-type selector switches   |   | Key-type selector switch  |
|-----------------------------------|--------------------------|---|---|---|---|---|---|---|
|                                   |                          | Non-illuminated models: A22-F, A22-T, A22-G, A22-S, A22-C, A22-D, A22-H, A22-M  | Illuminated models: A22L-T, A22L-G, A22L-H, A22L-D, A22L-C                          | Non-illuminated models: A22E  | Illuminated models: A22EL   | Non-illuminated models: A22S  | Illuminated models: A22W  | Non-illuminated models: A22K  |
| Allowable operating frequency     | Mechanical               | Momentary operation: 60 operations/min max.   |   | 30 operations/min max.  |   | Manual release: 30 operations/min max.<br>Automatic release: 30 operations/min max. |   |   |
|                                   | Electrical               | 30 operations/min max.  |   |   |   | 30 operations/min max.  |   |   |
| Insulation resistance             |                          | 100 MΩ min. (at 500 VDC)  |   |   |   |   |   |   |
| Dielectric strength               |                          | 2,500 VAC, 50/60 Hz for 1 min between terminals of same polarity<br>2,500 VAC, 50/60 Hz for 1 min between terminals of different polarity and also between each terminal and ground |   |   |   |   |   |   |
| Vibration resistance (See note 2) |                          | Malfunction: 10 to 55 Hz, 1.5-mm double amplitude (malfunction within 1 ms)   |   |   |   |   |   |   |
| Shock resistance                  | Mechanical               | 1,000 m/s <sup>2</sup> {100G}   | 1,000 m/s <sup>2</sup> {100G}   | 1,000 m/s <sup>2</sup> {100G}   |   | 1,000 m/s <sup>2</sup> {100G}   | 1,000 m/s <sup>2</sup> {100G}   | 1,000 m/s <sup>2</sup> {100G}   |
|                                   | Malfunction (See note 2) | 1,000 m/s <sup>2</sup> {100G} max.  | 600 m/s <sup>2</sup> {60G} max.   | 250 m/s <sup>2</sup> {25G} max.   |   | 1,000 m/s <sup>2</sup> {100G} max.  | 600 m/s <sup>2</sup> {60G} max.   | 1,000 m/s <sup>2</sup> {100G} max.  |
| Life expectancy                   | Mechanical               | Momentary operation: 5,000,000 operations min.  |   | Momentary operation: 300,000 operations min.  |   | 500,000 operations min.   | 100,000 operations min.   | 500,000 operations min.   |
|                                   | Electrical               | 500,000 operations min.   |   | 300,000 operations min.   | 300,000 operations min.   | 500,000 operations min.   | 100,000 operations min.   | 500,000 operations min.   |
| Ambient temperature (See note 1)  |                          | Operating: -20°C to 70°C (-4°F to 158°F)<br>Storage: -40°C to 70°C (-40°F to 158°F)   | Operating: -20°C to 55°C (-4°F to 131°F)<br>Storage: -40°C to 70°C (-40°F to 158°F) | Operating: -20°C to 70°C (-4°F to 158°F)<br>Storage: -40°C to 70°C (-40°F to 158°F) | Operating: -20°C to 55°C (-4°F to 131°F)<br>Storage: -40°C to 70°C (-40°F to 158°F) | Operating: -20°C to 70°C (-4°F to 158°F)<br>Storage: -40°C to 70°C (-40°F to 158°F) | Operating: -20°C to 55°C (-4°F to 131°F)<br>Storage: -40°C to 70°C (-40°F to 158°F) | Operating: -20°C to 70°C (-4°F to 158°F)<br>Storage: -40°C to 70°C (-40°F to 158°F) |
| Ambient humidity                  |                          | Operating: 35% to 85%   |   |   |   |   |   |   |
| Degree of protection              |                          | IP65  |   |   |   |   |   |   |
| Electric shock protection class   |                          | Class II  |   |   |   |   |   |   |
| Degree of contamination           |                          | 3 (IEC947-5-1)  |   |   |   |   |   |   |



Note: 1. With no icing or condensation.  
2. Malfunction within 1 ms.

■ OPERATING CHARACTERISTICS (FOR SPST-NO/SPST-NC)

| Item                          | Pushbutton switches  | Emergency stop switches                         | Knob-type selector switch  |  | Key-type selector switch                        |  |
|-------------------------------|--|---|--|--|---|--|
|                               | Illuminated<br>Non-illuminated<br>Pushbutton<br>Switches   | Push-lock<br>turn-reset<br>system               | Manual release   | Automatic<br>release   | Manual release                                  | Automatic<br>release   |
|                               | A22-F, A22-G,<br>A22-C, A22-S,<br>A22-T, A22-H,<br>A22-D, A22-M,<br>A22L-T, A22L-H,<br>A22L-D, A22L-G,<br>A22L-C | A22E  | A22S, A22W   | A22S, A22W   | A22K  |  |
| Total travel force (TTF) max. | 29.4 N {3.0 kgf}   | 44.1 N {4.5 kgf}                                | 0.34 N • m<br>{3.5 kgf • cm}<br>(See note)                       | 0.25 N • m<br>{2.5 kgf • cm} for<br>two position<br>(See note)<br><br>0.34 N • m<br>{3.5 kgf • cm} for<br>three position | 0.34 N {3.5 gf}<br>(See note)                   | 0.25 N • m<br>{2.5 kgf • cm} for<br>three position<br>(See note)<br><br>0.34 N • m<br>{3.5 kgf • cm} for<br>three position |
| Total travel (TT)             | 5.5 mm max.  | 10±1 mm   | Approx. 90° for two position<br>(Approx. 45° for three position) |  | Approx. 90° for two position                    |  |
| Releasing force (RF) min.     | —  | 0.25 N • m max.<br>{2.5 kgf • cm}<br>(See note) | 0.34 N • m max.<br>{3.5 kgf • cm}<br>(See note)                  | —  | 0.34 N • m max.<br>{3.5 kgf • cm}<br>(See note) | —  |









Note: Rotation torque for Emergency Stop Pushbutton, Knob-type Selector, and Key-type Selector Switches.

## Accessories (Order Separately)

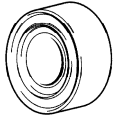
| Item                | Appearance  | Classification                           | Remarks   | Part number                  |                  |
|---------------------|---|--|---|------------------------------|------------------|
| Contact Blocks      |  | SPST-NO                                  | Provided as standard. Order Contact Blocks only when adding or replacing them.  | General-purpose load         | <b>A22-10</b>    |
|                     |   |  |   | Microload                    | <b>A22-10S</b>   |
|                     |   | SPST-NC                                  |   | General-purpose load         | <b>A22-01</b>    |
|                     |   |  |   | Microload                    | <b>A22-01S</b>   |
|                     |   | DPST-NO                                  |   | General-purpose load         | <b>A22-20</b>    |
|                     |   |  |   | Microload                    | <b>A22-20S</b>   |
|                     |   | DPST-NC                                  |   | General-purpose load         | <b>A22-02</b>    |
|                     |   |  |   | Microload                    | <b>A22-02S</b>   |
| Lamp Sockets        |  | Direct lighting                          | Used when changing the lighting method.   | <b>A22-TN</b>                |                  |
|                     |   | Transformer illumination                 |   | 110 VAC                      | <b>A22-T1</b>    |
|                     |   |  |   | 220 VAC                      | <b>A22-T2</b>    |
| Mounting Latches    |  | For momentary models                     | Provided as standard. Order Mounting Latches only when mounting Contact Blocks or Lamp Sockets that are purchased individually. | <b>A22-3200</b>              |                  |
| Legend plate frames | Standard size   | With Snap-in Legend Plate (Without text) | Snap-in Legend Plate is acrylic.  | White                        | <b>A22Z-3321</b> |
|                     |   |  |   | Red                          | <b>A22Z-3322</b> |
|                     |   |  |   | Black                        | <b>A22Z-3323</b> |
|                     |   |  |   | Without Snap-in Legend Plate | <b>A22Z-3320</b> |
|                     | Large size  | With Snap-in Legend Plate (Without text) |   | White                        | <b>A22Z-3331</b> |
|                     |   |  |   | Red                          | <b>A22Z-3332</b> |
|                     |   |  |   | Black                        | <b>A22Z-3333</b> |
|                     |   |  |   | Without Snap-in Legend Plate | <b>A22Z-3330</b> |



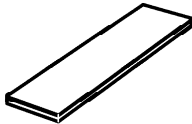
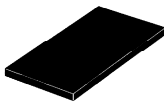

(This table continues on the next page.)

(continued from previous page)

| Item                      | Appearance   | Classification  | Remarks  | Part number   |  |   |   |
|---------------------------|--|---|--|---|--|---|---|
| Lock fitting              |   | Round   | The body is equipped with a Lock Fitting. This Lock Fitting is used when a more secure lock feature is required.   | <b>A22Z-3360</b>  |  |   |   |
| Metallic bezel rings      |   | For flush or projection models  | Replace with the standard model.<br>Material: nickel-plated zinc   | <b>A22Z-3580</b>  |  |   |   |
|                           |  | For full-guard models   |  | <b>A22Z-3582</b>  |  |   |   |
| Sealing caps              |   | For flush models  | Used to prevent dust or water from entering the Operational Unit.<br>Color: opaque<br>Material: silicon            | <b>A22Z-3600F</b>   |  |   |   |
|                           |  | For extended models   |  | <b>A22Z-3600T</b>   |  |   |   |
|                           |  | For full-guard models   |  | <b>A22Z-3600G</b>   |  |   |   |
| Color lenses              |   | Red   | Used for changing the Operational Unit color of the Pushbutton Switch.   | <b>A22Z-30TR</b>  |  |   |   |
|                           |  | Green   |  | <b>A22Z-30TG</b>  |  |   |   |
|                           |  | Yellow  |  | <b>A22Z-30TY</b>  |  |   |   |
|                           |  | White   |  | <b>A22Z-30TW</b>  |  |   |   |
|                           |  | Blue  |  | <b>A22Z-30TA</b>  |  |   |   |
| Three-throw spacers       |   | For Pushbutton Switches   | Used when mounting three Non-Illuminated Switch Units.<br>Cannot be used with Illuminated Emergency Stop Switches. | <b>A22Z-3003</b>  |  |   |   |
| Hole plug                 |   | Round   | Can be plugged into pre-cut panel holes for future expansion. The color is black.                                  | <b>A22Z-3550</b>  |  |   |   |
| 25 mm-dia. ring           |  | 25 mm ring  | Can be fit into a 25 mm-dia. hole in the panel. Since this is not attached to the main body, order separately.     | <b>A22Z-R25</b>   |  |   |   |
| Snap-in legend plates     | Standard size  |  | Without text   | Black   | Attached to the Standard-size Legend Plate Frame.<br>Material: Acrylic | <b>A22Z-3443B</b>   |   |
|                           |  |   |  | Red   |  | <b>A22Z-3443R</b>   |   |
|                           |  |   |  | White   |  | <b>A22Z-3443W</b>   |   |
|                           |  |   |  | Transparent   |  | <b>A22Z-3443C</b>   |   |
|                           |  |   |  | White text on red background  |  | ○   | <b>A22Z-3443R-2</b>   |
|                           |  |   |  |   |  | STOP  | <b>A22Z-3443R-4</b>   |
|                           |  |   |  | White text on black background  |  |   | <b>A22Z-3443B-1</b>   |
|                           |  |   |  |   |  | START   | <b>A22Z-3443B-3</b>   |
|                           |  |   |  |   |  | ON  | <b>A22Z-3443B-5</b>   |
|                           |  |   |  |   |  | OFF   | <b>A22Z-3443B-6</b>   |
|                           | UP   | <b>A22Z-3443B-7</b>   |  |   |  |   |   |
|                           | Large size   |  | Without text   | Black   | Attached to the Large-size Legend Plate Frame<br>Material: Acrylic     | <b>A22Z-3453B</b>   |   |
|                           |  |   |  | Red   |  | <b>A22Z-3453R</b>   |   |
|                           |  |   |  | White   |  | <b>A22Z-3453W</b>   |   |
|                           |  |   |  | Transparent   |  | <b>A22Z-3453C</b>   |   |
| For Emergency Stop Switch |  |   |  |  |  | 60-dia. round plate with black letters on a yellow background | "EMERGENCY STOP" is engraved on the plate. Used as an Emergency Stop Switch Legend Plate. |
|                           | 90-dia. round plate with black letters on a yellow background                      | <b>A22Z-3476-1</b>  |  |   |  |   |   |

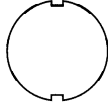
(This table continues on the next page.)

(continued from previous page)

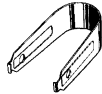
| Item                 | Appearance  | Classification          | Remarks  | Part number        |                    |
|----------------------|---|-------------------------|--|--------------------|--------------------|
| Character films      |  | No print (Round)        | After printing on a film, affix to the indicator plate of the Illuminated Pushbutton Switch. (The back is coated with adhesive.) | <b>A22Z-3460</b>   |                    |
|                      |   | Character print (Round) |  |                    | <b>A22Z-3460-1</b> |
|                      |   |                         |  | ○                  | <b>A22Z-3460-2</b> |
|                      |   |                         |  | START              | <b>A22Z-3460-3</b> |
|                      |   | STOP                    |  | <b>A22Z-3460-4</b> |                    |
| No print (Square)    | <b>A22Z-3480</b>  |                         |  |                    |                    |
| Lamp extractor       |  | —                       | Rubber tool used to easily replace Lamps.  | <b>A22Z-3901</b>   |                    |
| Tightening wrench    |  | —                       | Tool used to tighten nuts from the back of the panel.  | <b>A22Z-3905</b>   |                    |
| Lens tightening tool |  | —                       | Used for replacing the cap of the Half-guard Pushbutton Switch.  | <b>A22Z-3908</b>   |                    |
| Lens puller          |  | —                       | Used for removing the lens from the indicator of the Square Illuminated Pushbutton Switch.                                       | <b>A3PJ-5080</b>   |                    |

■ ENCLOSURES

| Material  | Hole size           | Number of holes | Part number         |
|-----------|---------------------|-----------------|---------------------|
| Polyester | 22.5 mm (0.88 in)   | 1               | <b>A22N-PENC-1</b>  |
|           |                     | 2               | <b>A22N-PENC-2</b>  |
|           |                     | 3               | <b>A22N-PENC-3</b>  |
| Metallic  | 22.5 mm (0.88 in)   | 1               | <b>A22N-MENC-1</b>  |
|           |                     | 2               | <b>A22N-MENC-2</b>  |
|           |                     | 3               | <b>A22N-MENC-3</b>  |
|           |                     | 4               | <b>A22N-MENC-4</b>  |
|           |                     | 6               | <b>A22N-MENC-6</b>  |
|           |                     | 9               | <b>A22N-MENC-9</b>  |
|           |                     | 12              | <b>A22N-MENC-12</b> |
| 16        | <b>A22N-MENC-16</b> |                 |                     |

Note: For more information on pushbutton enclosures refer to drawings in the *Dimensions* section.

■ NAMEPLATE NOMENCLATURE

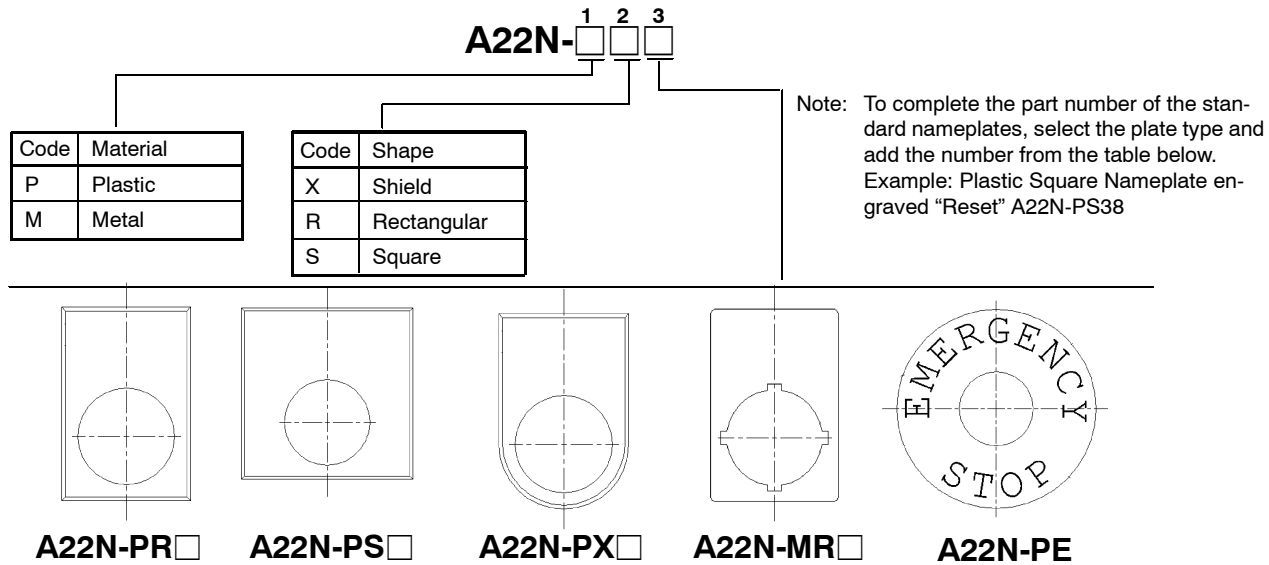

|    |                  |     |               |     |               |     |                 |      |                   |
|----|------------------|-----|---------------|-----|---------------|-----|-----------------|------|-------------------|
| 1  | AUTO             | 30  | ON            | 106 | HIGH-LOW      | 150 | AUTO-MAN-OFF    | 175  | START-JOG-STOP    |
| 2  | CLOSE            | 31  | OPEN          | 107 | INCH-REVERSE  | 151 | AUTO-OFF-HAND   | 176  | START-RUN-STOP    |
| 3  | CYCLE START      | 32  | OUT           | 108 | JOG-FOR       | 152 | AUTO-OFF-MAN    | 177  | UP-OFF-DOWN       |
| 4  | CYCLE STOP       | 33  | POWER ON      | 109 | JOG-REV       | 153 | CLOSE-OFF-OPEN  | 178  | 1-OFF-2           |
| 5  | DECREASE         | 34  | PULL TO START | 110 | JOG-RUN       | 154 | DOWN-OFF-SLOW   | 179  | HAND-OFF-AUTO     |
| 6  | DOWN             | 35  | PUSH TO TEST  | 111 | LEFT-RUN      | 155 | FAST-OFF-SLOW   | 180  |                   |
| 7  | EMERG.STOP (red) | 36  | PUSH TO STOP  | 112 | LOWER-RAISE   | 156 | FOR-OFF-REV     | 181  |                   |
| 8  | FAST             | 37  | RAISE         | 113 | MAN-AUTO      | 157 | FOR-STOP-REV    | 182  |                   |
| 9  | FAULT            | 38  | RESET         | 114 | OFF-ON        | 158 | HIGH-LOW-OFF    | 183  |                   |
| 10 | FEED             | 39  | REVERSE       | 115 | ON-OFF        | 159 | HIGH-OFF-LOW    | 184  |                   |
| 11 | FEED START       | 40  | RIGHT         | 116 | OPEN-CLOSE    | 160 | JOG-SAFE-RUN    | 185  |                   |
| 12 | FEED STOP        | 41  | RUN           | 117 | RAISE-LOWER   | 161 | JOG-STOP-RUN    | 186  |                   |
| 13 | FLUID LEVEL LOW  | 42  | SLOW          | 118 | REV-FOR       | 162 | LEFT-OFF-RIGHT  | 187  | I-II-III          |
| 14 | FORWARD          | 43  | SPEED         | 119 | RUN-INCH      | 163 | LOC-OFF-REMOTE  | 188  | III               |
| 15 | FULL SPEED       | 44  | START         | 120 | RUN-JOG       | 164 | LOW-OFF-HIGH    | 190  | 60 MM E-STOP      |
| 16 | HAND             | 45  | STOP          | 121 | RUN-SAFE      | 165 | LOWER-OFF-RAISE | 191  | 90 MM E-STOP      |
| 17 | HIGH             | 46  | TEST          | 122 | SAFE-RUN      | 166 | OFF COOLANT ON  | 200  | BLANK NAMEPLATE   |
| 18 | IN               | 47  | UP            | 123 | SLOW-FAST     | 167 | OFF-LOC-REMOTE  | 200E | SPECIAL ENGRAVING |
| 19 | INCH             | 48  | 1ST SPEED     | 124 | START-JOG     | 168 | OFF-MAN-AUTO    |      |                   |
| 20 | INCREASE         | 49  | 2ND SPEED     | 125 | START-STOP    | 169 | OFF-SLOW-FAST   |      |                   |
| 21 | JOG              | 50  | 3RD SPEED     | 126 | STOP-START    | 170 | OFF-1-2         |      |                   |
| 22 | JOG FORWARD      | 51  | 4TH SPEED     | 127 | SUMMER-WINTER | 171 | OPEN-OFF-CLOSE  |      |                   |
| 23 | LEFT             | 100 | AUTO-MAN      | 128 | UP-DOWN       | 172 | RAISE-OFF-LOWER |      |                   |
| 24 | LOW              | 101 | CLOSE-OPEN    |     |               | 173 | SLOW-OFF-FAST   |      |                   |
| 25 | LOW SPEED        | 102 | DOWN-UP       |     |               | 174 | SLOW-OFF-START  |      |                   |
| 26 | LOWER            | 103 | FAST-SLOW     |     |               |     |                 |      |                   |
| 27 | MOTOR RUN        | 104 | FOR-REV       |     |               |     |                 |      |                   |
| 28 | MOTOR STOP       | 105 | HAND-AUTO     |     |               |     |                 |      |                   |
| 29 | OFF              |     |               |     |               |     |                 |      |                   |

Note: All plastic name plates are adhesive backed, contain beveled edges and are supplied standard with white lettering on black background. Any deviation from items listed here will be a special order. Contact Omron.

# Dimensions

Unit: mm (inch)

## ■ LEGEND PLATE FRAMES

A22Z-332 □

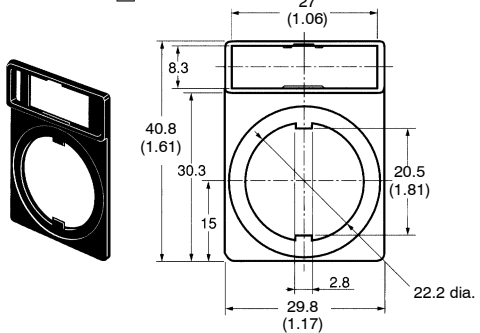

A22Z-333 □

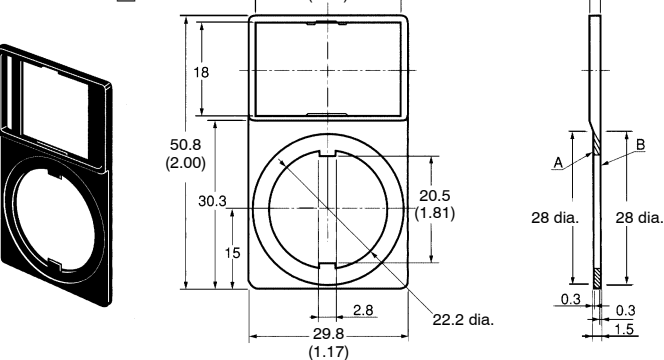

## ■ PLASTIC RECTANGULAR AND SHIELD

A22N-PR □

A22N-PX □

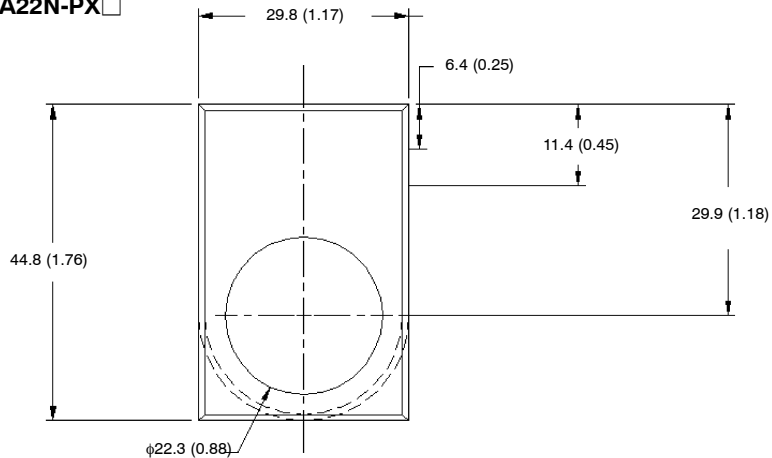

Note: Curved dashed line denotes difference between Rectangular and Rectangular to Round name plates.

## ■ PLASTIC SQUARE

A22N-PS □

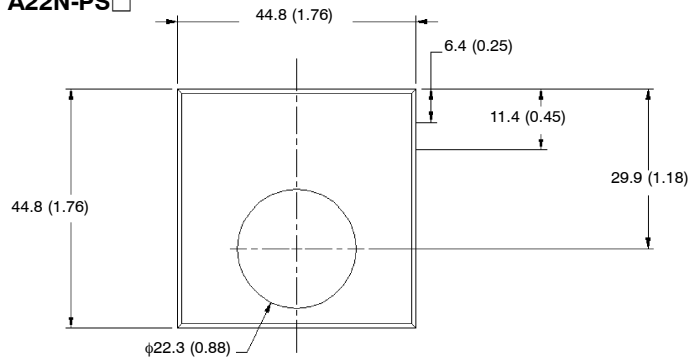

■ METAL RECTANGULAR

A22N-MR□

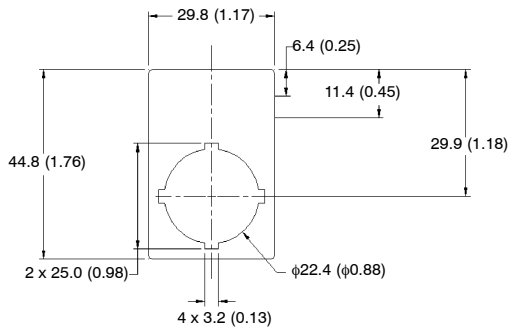

■ 60MM EMERGENCY STOP

A22PE190

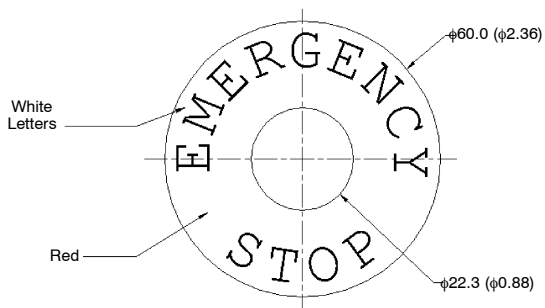

■ 90MM EMERGENCY STOP

A22N-PE191

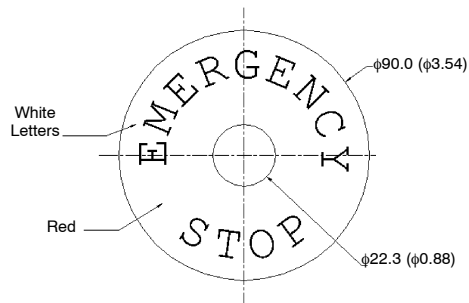



**LOCK FITTING**  
A22Z-3360

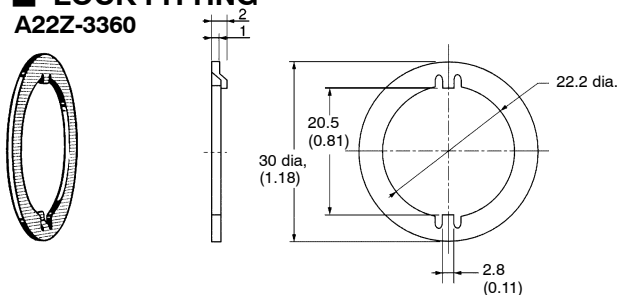

**25 MM-DIA. RING**  
A22Z-R25

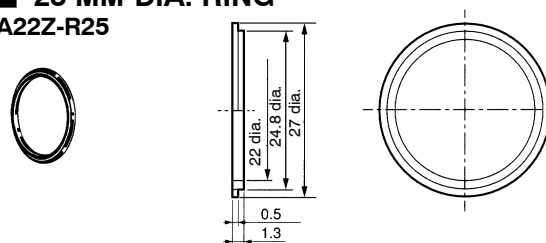

**COLOR LENS**  
A22L-30T□

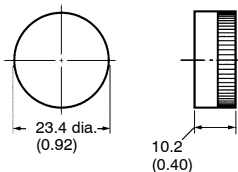

**HOLE PLUG (ROUND)**  
A22Z-3530

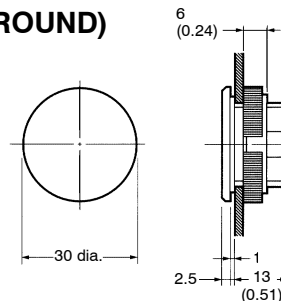

**SEALING CAPS**

For Flush Models  
A22Z-3600F

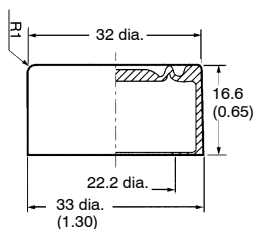
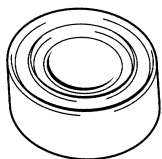

For Extended Head Models  
A22Z-3600T

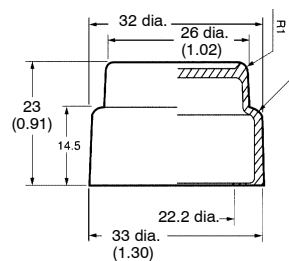

For Full-guard Models  
A22Z-3600G

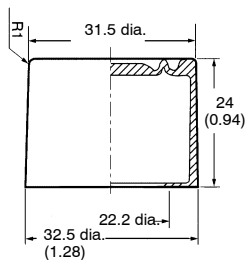

■ **THREE-THROW SPACER**

A22Z-3003

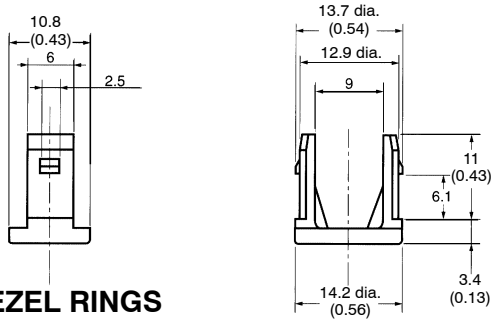
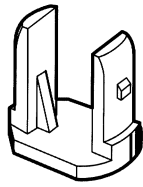

■ **METALLIC BEZEL RINGS**

For Flush/Extended Models  
A22Z-3580

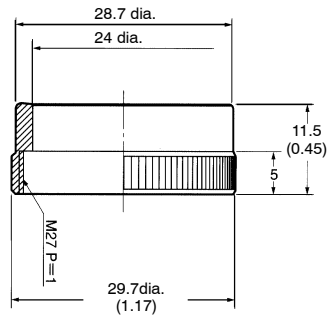
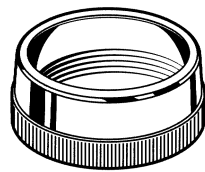

For Full-guard Models  
A22Z-3582

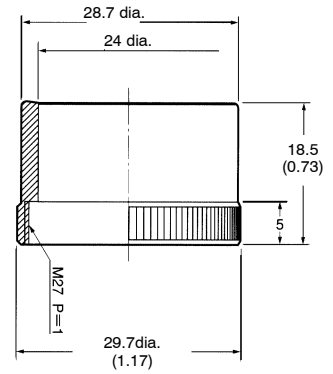
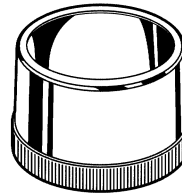

■ **SNAP-IN LEGEND PLATES**

For General-purpose Models  
A22L-3443 □-□

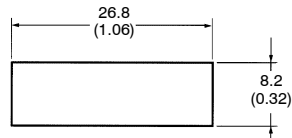
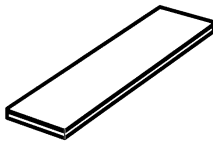

For Large Models  
A22Z-3453 □

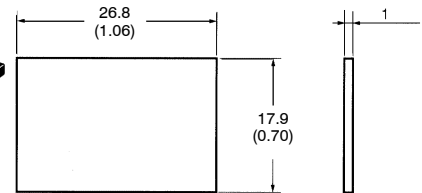
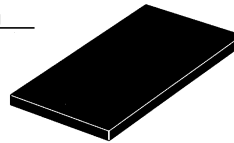

■ **CHARACTER FILM**

For Round Models  
A22Z-3460-□

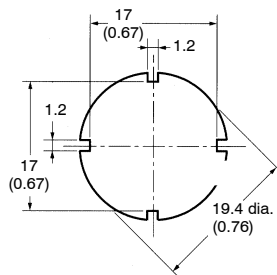
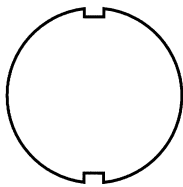

For Square Models  
A22Z-3480

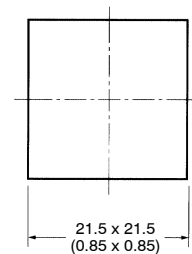
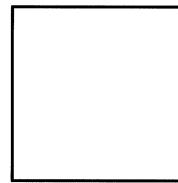

Unit: mm (inch)

■ LAMP EXTRACTOR

A22Z-3901

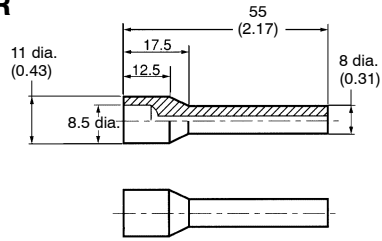

■ TIGHTENING WRENCH

A22Z-3905

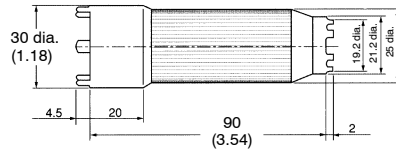
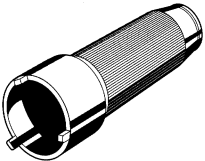

■ LENS TIGHTENING TOOL

A22Z-3908

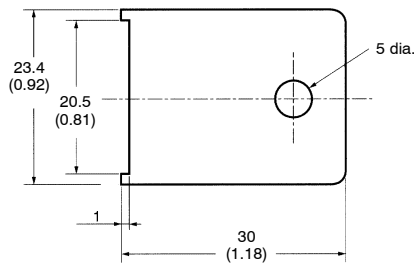
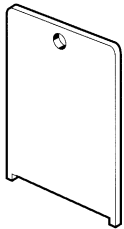

■ LENS PULLER

A3PJ-5080

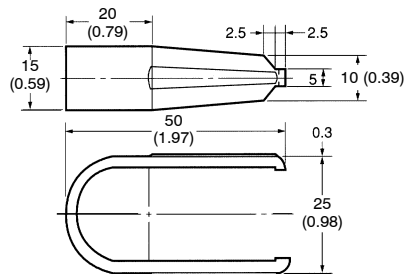
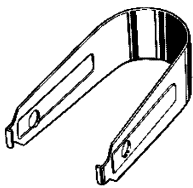

■ ENCLOSURES (POLYESTER)

A22N-PENC-□

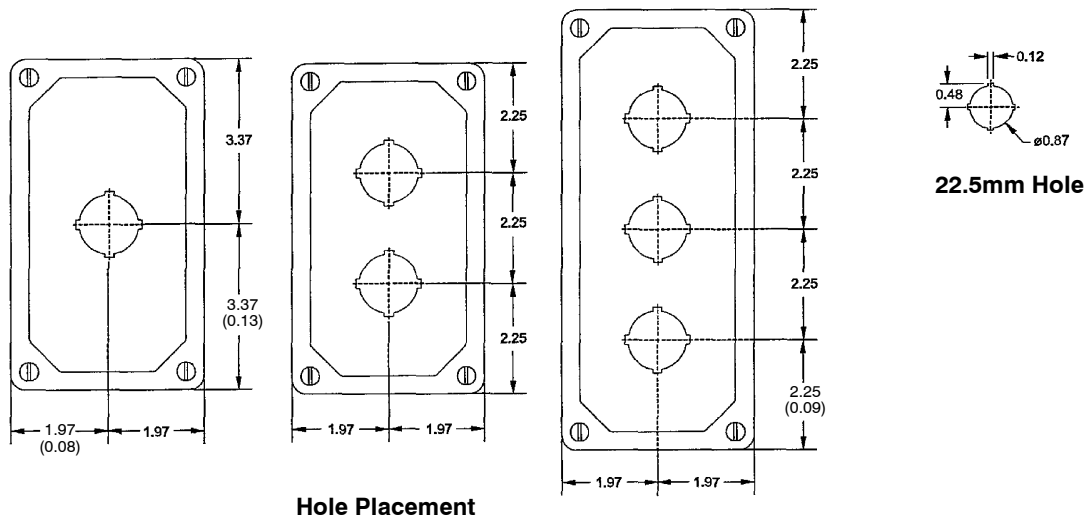
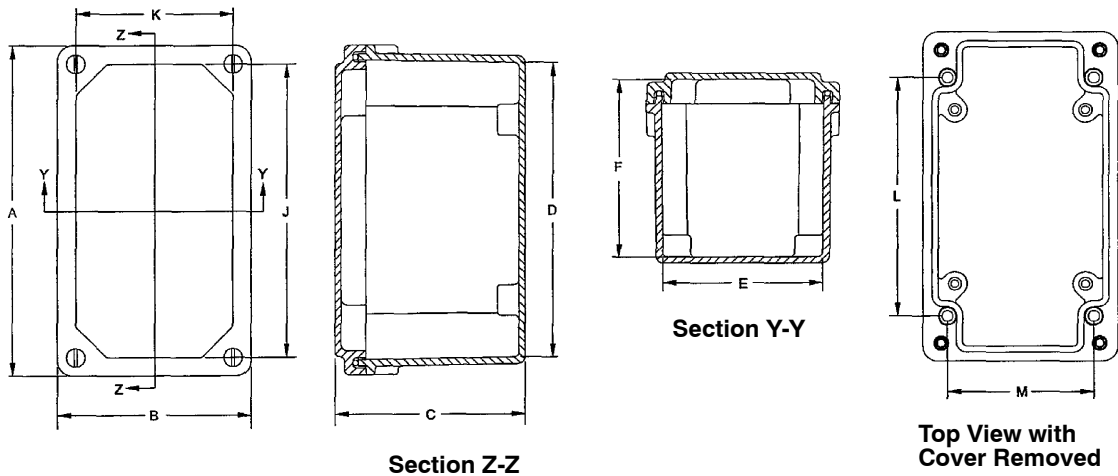

| Part No.    | Overall Dimensions |      |      | Inside Dimensions |      |      |      | J    | K    | L    | M | No. of Holes | Hole Size |
|-------------|--------------------|------|------|-------------------|------|------|------|------|------|------|---|--------------|-----------|
|             | A                  | B    | C    | D                 | E    | F    |      |      |      |      |   |              |           |
| A22N-PENC-1 | 6.74               | 3.93 | 3.88 | 6.01              | 3.26 | 3.63 | 5.99 | 3.18 | 4.88 | 2.94 | 1 | 22.5         |           |
| A22N-PENC-2 | 6.74               | 3.93 | 3.88 | 6.01              | 3.26 | 3.63 | 5.99 | 3.18 | 4.88 | 2.94 | 2 | 22.5         |           |
| A22N-PENC-3 | 8.99               | 3.93 | 3.88 | 8.26              | 3.26 | 3.63 | 8.24 | 3.18 | 7.13 | 2.94 | 3 | 22.5         |           |

■ ENCLOSURES (METALLIC)

A22N-MENC-□

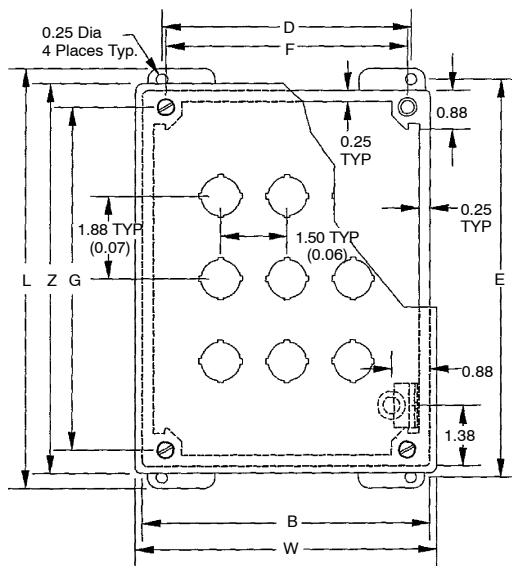

Body Type MENC-6 through MENC-16 (hinged)

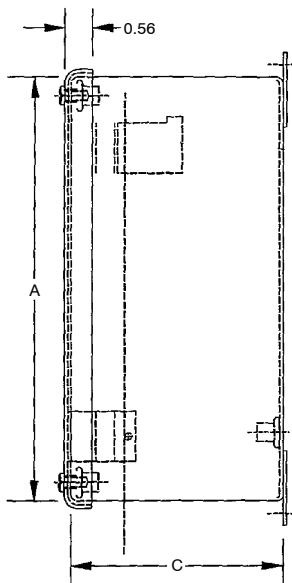

Side View

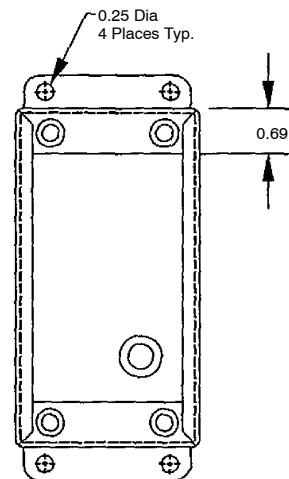

Body Type MENC-1 MENC-2, MENC-3 and MENC-4 (not hinged)

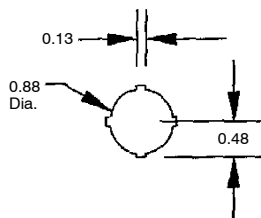

Typical Pushbutton Detail

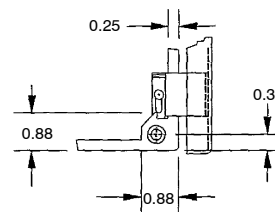

Hinge Detail

Retractable pin allows door to be mounted on left or right side

| Part No.     | No. of Holes | Overall Dimensions |      |      |      |       |      |      |       |      | Ship Wt. lbs. |   |
|--------------|--------------|--------------------|------|------|------|-------|------|------|-------|------|---------------|---|
|              |              | A                  | B    | C    | D    | E     | F    | G    | L     | W    |               | Z |
| A22N-MENC-1  | 1            | 3.25               | 2.75 | 3.50 | 1.88 | 3.75  | 1.71 | 2.50 | 4.25  | 3.06 | 3.56          | 2 |
| A22N-MENC-2  | 2            | 5.13               | 2.75 | 3.50 | 1.88 | 5.63  | 1.71 | 4.38 | 6.13  | 3.06 | 5.44          | 3 |
| A22N-MENC-3  | 3            | 7.00               | 2.75 | 3.50 | 1.88 | 7.50  | 1.71 | 6.25 | 8.00  | 3.06 | 7.31          | 3 |
| A22N-MENC-4  | 4            | 8.88               | 2.75 | 3.50 | 1.88 | 9.38  | 1.71 | 8.13 | 9.88  | 3.06 | 9.19          | 4 |
| A22N-MENC-6  | 6            | 8.50               | 5.00 | 4.25 | 4.13 | 9.00  | 3.96 | 7.75 | 9.50  | 5.31 | 8.81          | 5 |
| A22N-MENC-9  | 9            | 8.50               | 6.50 | 4.25 | 5.63 | 9.00  | 5.46 | 7.75 | 9.50  | 6.81 | 8.81          | 6 |
| A22N-MENC-12 | 12           | 10.38              | 6.50 | 4.25 | 5.63 | 10.88 | 5.46 | 9.36 | 11.38 | 6.81 | 10.69         | 6 |
| A22N-MENC-16 | 16           | 10.38              | 8.00 | 4.25 | 7.13 | 10.88 | 6.96 | 9.63 | 11.38 | 8.31 | 10.69         | 7 |

# Installation

## ■ MOUNTING THE PANEL

### Panel Hole Dimensions

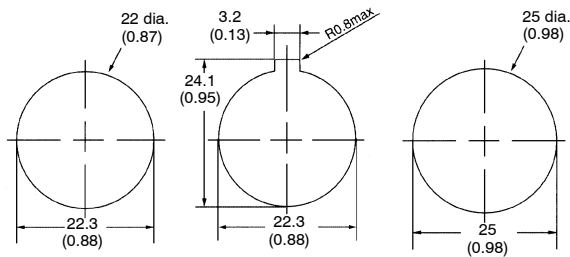

For 25 mm-dia. holes, always use 25 mm-dia. Rings. (Since the cutout dimensions are large, IP65 cannot be guaranteed unless 25-dia. Rings are used.)

If outer surface treatment such as paint is applied to the panel, the panel dimensions after outer surface treatment must meet the specified panel dimensions.

## ■ MATRIX INSTALLATION

- The following panel hole dimensions apply when Switch Units and the Standard-size Legend Plate Frame Lock Fitting are mounted.

### A22Z

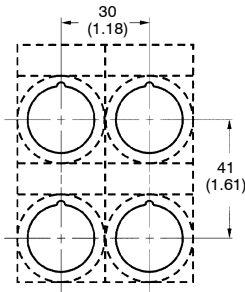

### A22N-PR, -MR, -PX

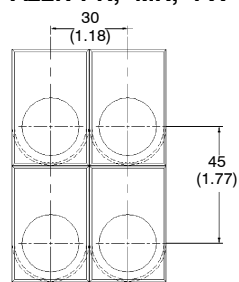

- The following panel hole dimensions apply when the Large-size Legend Plate Frame is mounted.

### A22Z

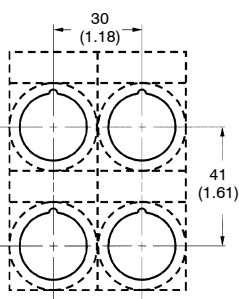

### A22N-S

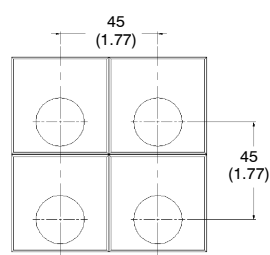

Locking should be applied toward the Engraving Plate.

**Note:** The above dimensions are the smallest-possible mounting dimensions. However, these dimensions do not apply to large Pushbutton Switches. For large Pushbutton Switches, determine the distance between holes, taking the Operational Unit and Legend Plate Frame into account.

## ■ MOUNTING THE OPERATIONAL UNIT ON THE PANEL

Insert the Operational Unit from the front surface of the panel, insert the Lock Fitting and the mounting nut from the terminal side, then tighten the nut. Before tightening, check that the rubber washer is present between the Operational Unit and the panel.

When using a Legend Plate Frame, put one rubber washer each between the Legend Plate Frame and the panel and between the Operational Unit and the Legend Plate Frame. (One rubber washer will be provided when one Legend Plate Frame is ordered.)

Align the Lock Fitting with the groove in the casing, then insert the Lock Fitting so that its edge is located on the panel side.

Tighten the mounting nut at a torque of 0.98 to 1.96 N • m {10 to 20 kgf • cm}.

When using a Lock Ring, replace with the supplied Lock Fitting, insert the projecting part into the lock slot, and then tighten the mounting nut.

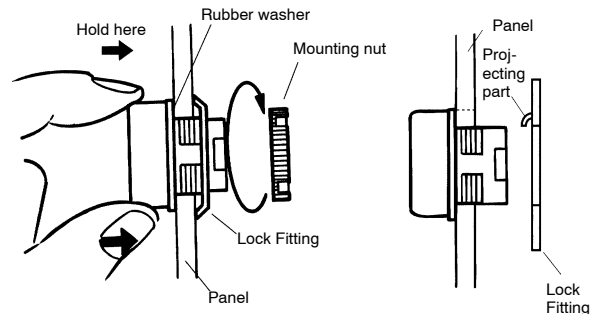

When the panel cutout dimension is 25 mm dia., remove the supplied rubber washer and mount the 25 mm-dia. Ring as shown below. (Since the A22Z-R25 is not attached to the main body, order separately.)

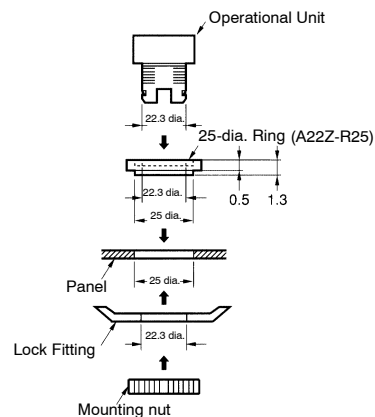

### ■ MOUNTING THE SWITCH ON THE OPERATIONAL UNIT

Insert the Operational Unit into the Switch Unit, aligning the arrow mark inscribed on the Operational Unit with the lever on the Switch Unit, then move the lever in the direction indicated by the arrow in the following figure.

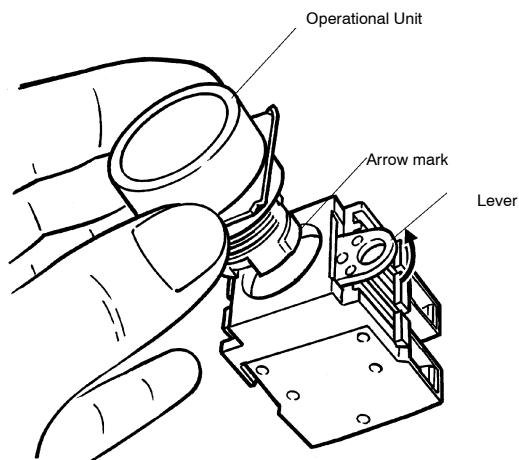

### ■ REMOVING THE SWITCH

Move the lever in the direction indicated by the arrow in the following figure, then pull the Operational Unit or the Switch Unit.

Since the lever has a hole with an inside diameter of 6.5 mm, the lever can be moved in the specified direction by inserting a screwdriver into the hole and then moving the screwdriver.

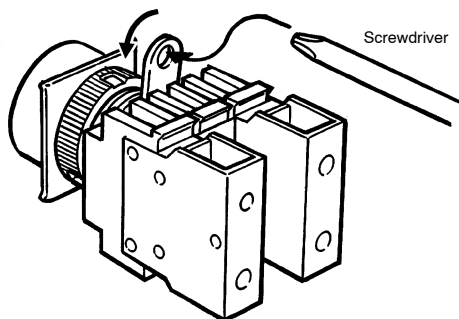

### ■ MOUNTING/REPLACING THE COLOR LENS

#### Projection, Full-guard

Grip and rotate the Color Lens with your fingers.

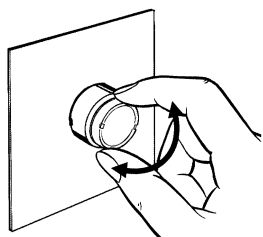

#### Half-guard Indicators

Put the tips of the Lens Tightening Tool (A22Z-3908) into the Color Lens slot and turn the Tool.

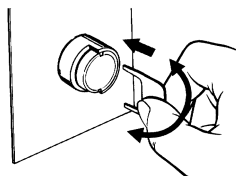

### ■ ASSEMBLING THE CAP

#### Lighted Pushbutton Switch

Mount the Color Lens so that the protrusions inside the cap fit into the grooves in the Operational Unit.

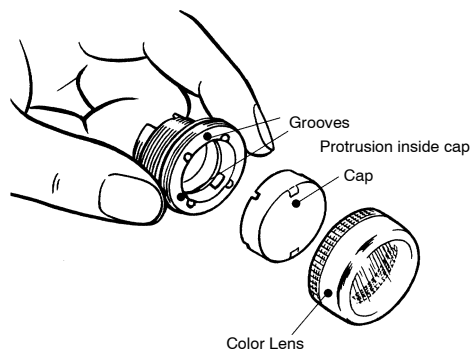

#### Indicator

Mount the Color Lens so that the protrusions inside the Operational Unit fit into the grooves in the cap.

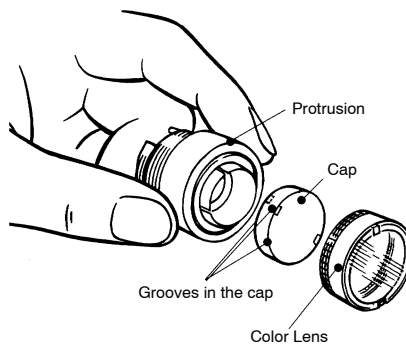

### Square Pushbutton/Indicator

#### Removing the Color Lens:

Insert the protruding tip of the Lens Puller (A3PJ-5080) into the lens slot, hold the plate spring, and pull them to remove the Color Lens.

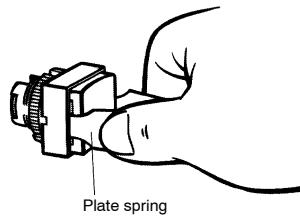

#### Mounting the Color Lens:

Mount the Color Lens on the flange and firmly push the Color Lens. When the Color Lens is inserted, check whether it operates properly. When replacing the Lamp, remove the Color Lens and diffusion plate with fingers or Lens Puller.

Attach the Character Film properly so that it fits inside the protruding part of the diffusion plate. Then, match the diffusion plate to the square flange and insert the Lens.

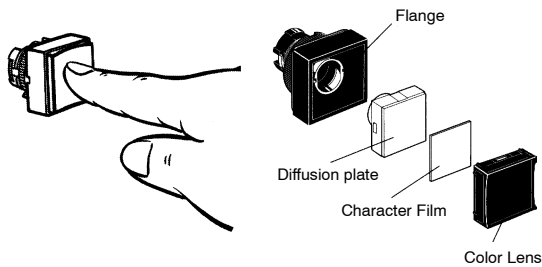

### EMERGENCY STOP SWITCH

Insert the protrusion of the Tightening Wrench (A22Z-3905) into the Cap slot and then turn to remove the Cap.

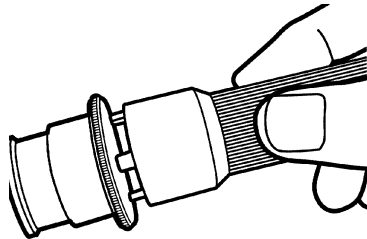

### INSTALLING/REPLACING THE LAMP

#### Installing from the Panel Surface

Insert the Lamp Extractor (A22Z-3901) into the lamp, then rotate the Extractor while pressing it.

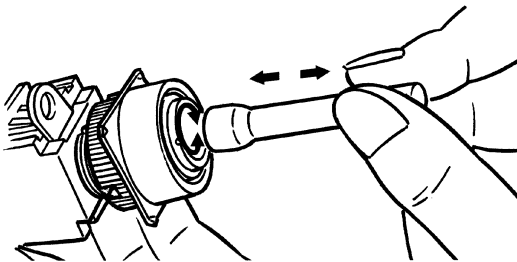

### Installing/Replacing on the Switch Unit

Grip the indicator with your fingers, then rotate the indicator while pressing it against the Switch Unit.

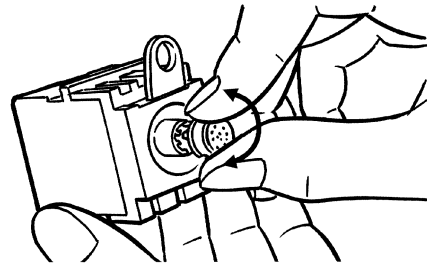

### CONTROL BOX (ENCLOSURE)

#### Mounting the Switch

The Standard-size Legend Plate Frame can be mounted. Mount the Frame as shown in the following diagram. Mount the Switch in the same way as for an ordinary panel.

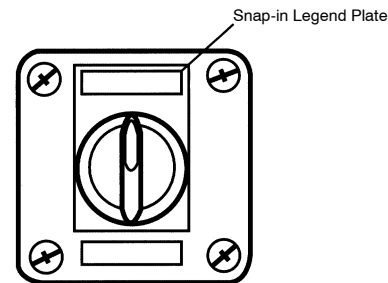

### INSTALLING/REMOVING THE SWITCH UNIT

#### Installing the Switch Unit

Hook the small protrusion on the Switch Unit into the groove on the other side of the lever, then push up the Switch Unit in the direction indicated by the arrow in the figure below.

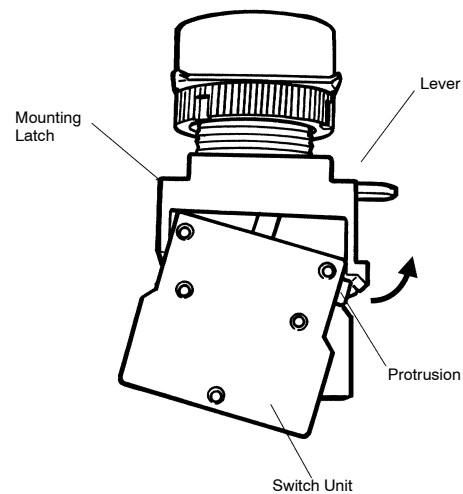



### Removing the Switch Unit

Insert a screwdriver between the Mounting Latch and the Switch Unit, then push down the screwdriver in the direction indicated by the arrow in the following figure.

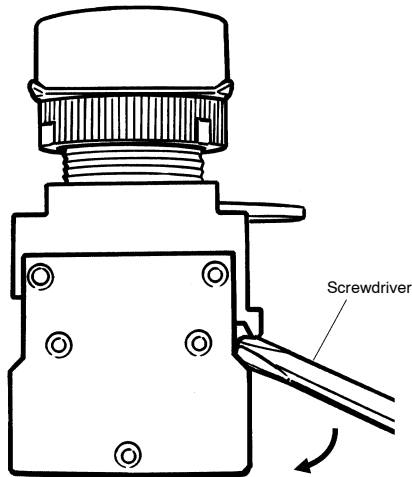
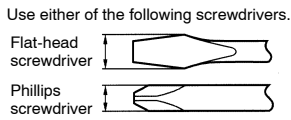

### WIRING

#### Wiring Round Crimp Terminals

Loosen the terminal screw from the Switch Unit until it completely comes off the groove, insert a screwdriver as shown in the following figure, then push up the washer in the direction indicated by the arrow to temporarily secure it. Now, a round crimp terminal can be connected. After inserting the terminal, tighten the screws to complete wiring.

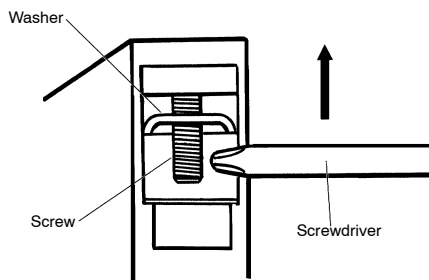

### ENGRAVING

Engrave the characters on the surface on the Cap. Make sure that the characters are aligned parallel to the imaginary line connecting the two protruding portions to the left and right of the Cap.

The characters must not be engraved deeper than 0.5 mm. Apply an alcohol-based paint coating, such as melamine, alkyd, or acrylic resin paint coating, to the engraved characters.

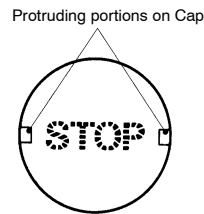

### AFFIXING CHARACTER FILM

Hold the Cap, remove the cardboard on the Film, and attach the Film to the Cap. Make sure that the protruding portions of the Cap engage the cutout portions of the Film and that the characters are aligned parallel to the imaginary line connecting the two protruding portions to the left and right of the Cap.

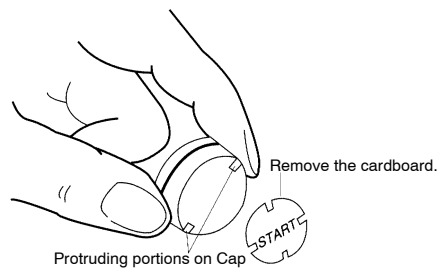

### MOUNTING AND DISMOUNTING SNAP-IN LEGEND

Press and secure the Snap-in Legend Plate onto the Legend Plate Frame.

The direction of the characters will vary with the mounting direction of the control panel if the Switch is a knob or key selector model.

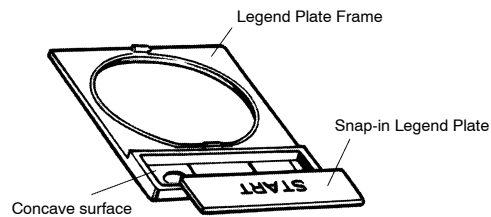

To easily remove the Snap-in Legend Plate from the Legend Plate Frame mounted to the panel, insert a Tool with a thin tip into the space between the Snap-in Legend Plate and the Legend Plate Frame.

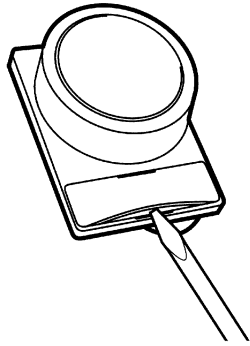

The Snap-in Legend Plate is easily removed by pressing the Snap-in Legend Plate from the back of the Legend Plate Frame.

The Legend Plate Frame is made of acrylic resin, which is easily damaged by shock. Be sure to handle the Legend Plate Frame with care.

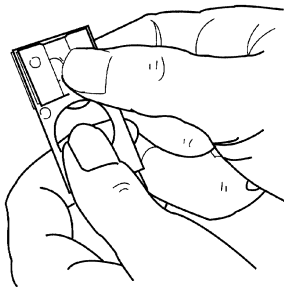

## ■ ENGRAVING METHOD

### Material: Acrylic

Engrave the characters directly on the matted side of the Snap-in Legend Plate.

The characters must be engraved no deeper than 0.5 mm.

Apply alcohol-based paint coating to the engraved characters.

If the Snap-in Legend Plate is transparent, engrave the mirror-written characters on the back of the Snap-in Legend Plate and apply paint coating to the characters. Then apply paint coating of a different color to the remaining part of the Snap-in Legend Plate.

## ■ MOUNTING THREE-THROW SPACER

Press and secure the two protruding portions of the Three-throw Spacer to the two indented portions of the inner side of the control panel.

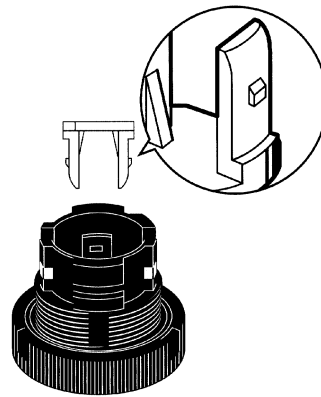

## Precautions

### ! WARNING

Do not apply a voltage between the incandescent lamp and the terminal that is greater than the rated voltage. If the incandescent lamp is broken, the Operational Units may pop out.

Always turn OFF the power and wait for 10 minutes before replacing the incandescent lamp. If the lamp is replaced immediately after the power is turned OFF, the remaining heat may cause burns.

## ■ CORRECT USE

### Mounting

Always make sure that the power is turned OFF before mounting, removing, or wiring the Switch, or performing maintenance.

Do not tighten the mounting ring more than necessary using tools such as pointed-nose pliers. Doing so will damage the mounting ring. The tightening torque is 0.98 to 1.96 N • m {10 to 20 kgf • cm}.

The panel thickness is 1 to 5 mm.

### Wiring

After wiring the Switch, maintain an appropriate clearance and creepage distance.

When DC-specific LEDs are used, wire the Switch so that the X1 terminal is positive.

Terminal screws must be Phillips or slotted M3.5 screws with a square washer.

The tightening torque is 1.08 to 1.27 N • m {11 to 13 kgf • cm}.

Single wires, stranded wires, and crimp terminals can be connected to the Switch.

### Operating Environment

The IP65 model is designed with a protective structure so that it will not sustain damage if it is subjected to water from any direction to the front of the panel.

**Using the Microload**

Insert a contact protection circuit, if necessary, to prevent the reduction of life expectancy due to extreme wear on the contacts caused by loads where inrush current occurs when the contact is opened and closed.

The minimum applicable load is the N-level reference value. This value indicates the malfunction reference level for the reliability level of 60% ( $\lambda . 60$ ) (conforming to JIS C5003).

The equation,  $\lambda . 60 = 0.5 \times 10^{-4} / \text{time}$  indicates that the estimated malfunction rate is less than 1/2,000,000 with a reliability level of 60%.

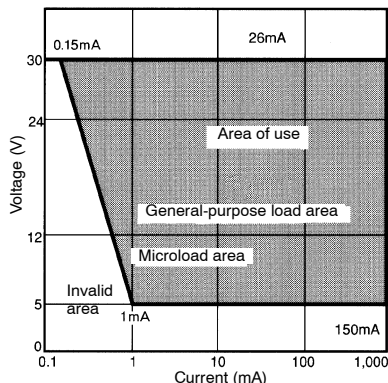

**LEDs**

The LED current-limiting resistor is built-in, so internal resistance is not required.

If commercially available LEDs are used, select the ones that meet the following conditions:

Base: BA9S/13□

Overall length: 26 mm max.

Power consumption: 2.6 W max.

**Others**

The oil-resistant IP65 uses NBR rubber and is resistant to general cutting oil and cooling oil. Some particular oils cannot be used with the oil-resistant IP65, however, so contact your OMRON representative for details.

If the panel is to be finished with coating, etc., make sure that the panel meets the specified dimensions after the coating.

Do not subject the Switch to extreme shock or vibration. Doing so will cause malfunctions and damage to the Switch.

Do not let sharp objects come into contact with the Switches that are made of resin. Doing so will damage the Switches, causing scratches on the outside of the Operational Units, and malfunction.

When handling the Switches, do not throw or drop them.

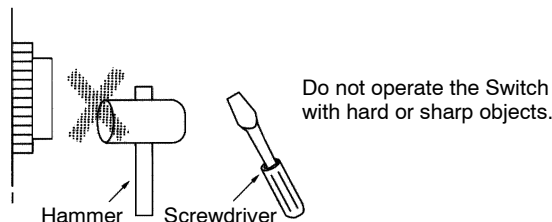
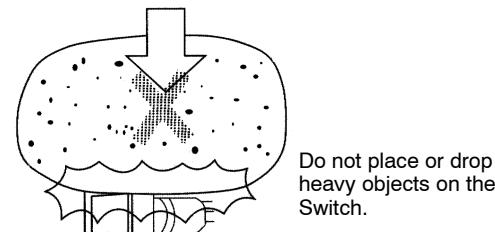
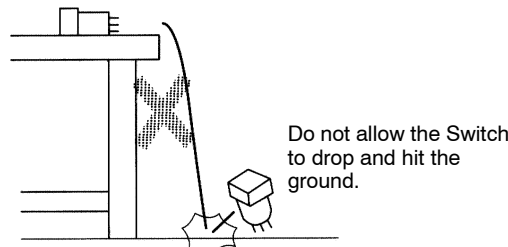

**NOTE: DIMENSIONS SHOWN ARE IN MILLIMETERS. To convert millimeters to inches divide by 25.4.**

**OMRON**<sup>®</sup>  
**OMRON ELECTRONICS LLC**  
 One East Commerce Drive  
 Schaumburg, IL 60173  
**1-800-55-OMRON**

**OMRON ON-LINE**  
 Global - <http://www.omron.com>  
 USA - <http://www.omron.com/oei>  
 Canada - <http://www.omron.com/oci>

**OMRON CANADA, INC.**  
 885 Milner Avenue  
 Scarborough, Ontario M1B 5V8  
**416-286-6465**