

SERIES 38B AND 38G
Sealed Subminiature Pushbutton Switches

FEATURES

- Drop-In Replacement for Industry Standard
- Choice of Terminations
- Printed Circuit Board Mount
- SPST, DPST and SPDT Momentary Contact



SERIES 38B

DIMENSIONS In inches (and millimeters)

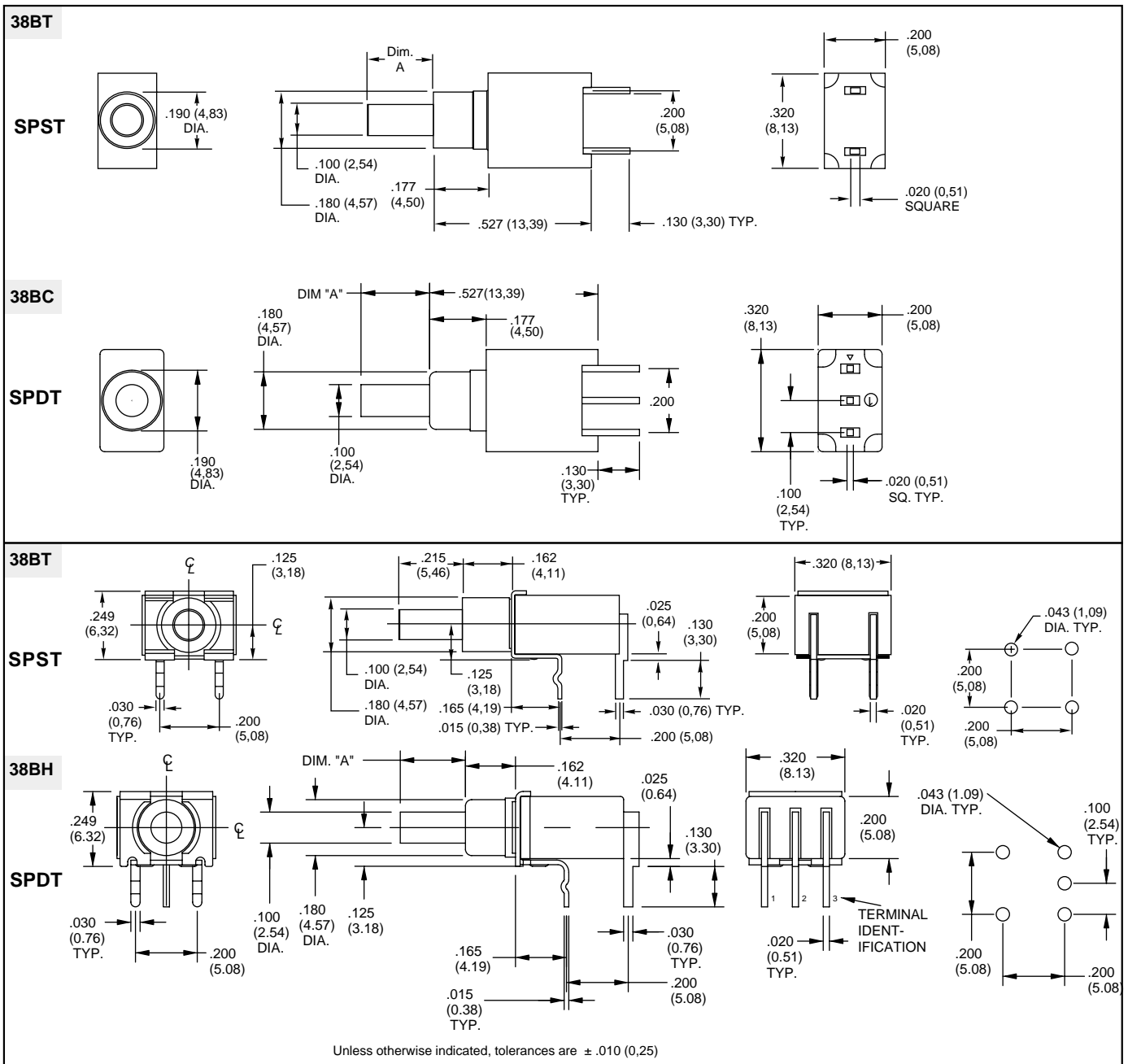

Pushbutton Switches

SERIES 38B

SPECIFICATIONS

Electrical Ratings

Operating Life: 80,000 make-and-break cycles at full load

Contact Rating (resistive load):

Gold Contacts: 0.4 VA maximum at 20 Vac or Vdc

Silver Contacts: 1.0 Amp maximum at 120 Vac or 28 Vdc

Contact Resistance: Below 20 milliohms typical initial at 2-4 Vdc, 100 mA, for both silver and gold-plated contacts

Insulation Resistance: 1000 megaohms minimum

Voltage Breakdown: 1000 Vrms minimum at sea level

Operating Temperature: -30°C. to +85°C.

Solderability: Per MIL-STD-202F, Method 208D, or EIA RS-186E, Method 9 (1 hour steam aging)

Materials and Finishes

Base and Cover: Thermoplastic (UL 94V-0)

Plunger: Thermoplastic (UL 94V-0), (S versions include an internal o-ring seal)

Terminals: Copper alloy, solder plate over nickel plate, solder plate

Spring: Plated music wire

Contact System: Copper alloy, gold or silver plate (as specified) over nickel plate

CIRCUITRY

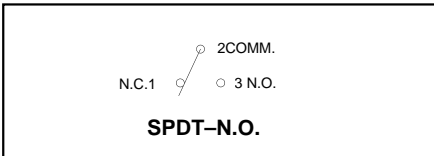
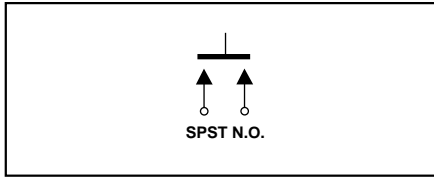

ORDERING INFORMATION

Series: 38BT = SPST, Momentary, Thru-Hole
 38BC = SPDT, Momentary, Thru-Hole, Vertical
 38BH = SPDT, Momentary, Thru-Hole, Horizontal

Dimension A: 0 = 0.020" 4 = 0.215"

Seal: S = O-Ring Seal, N = No Seal

Plating: 1 = Gold Contact, Solder Terminals
 2 = Silver Contacts, Solder Terminals
 3 = Gold Contacts and Terminals
 4 = Silver Contacts and Terminals

Orientation: V = Vertical to PCB, H = Horizontal to PCB

SERIES 38G

DIMENSIONS In inches (and millimeters)

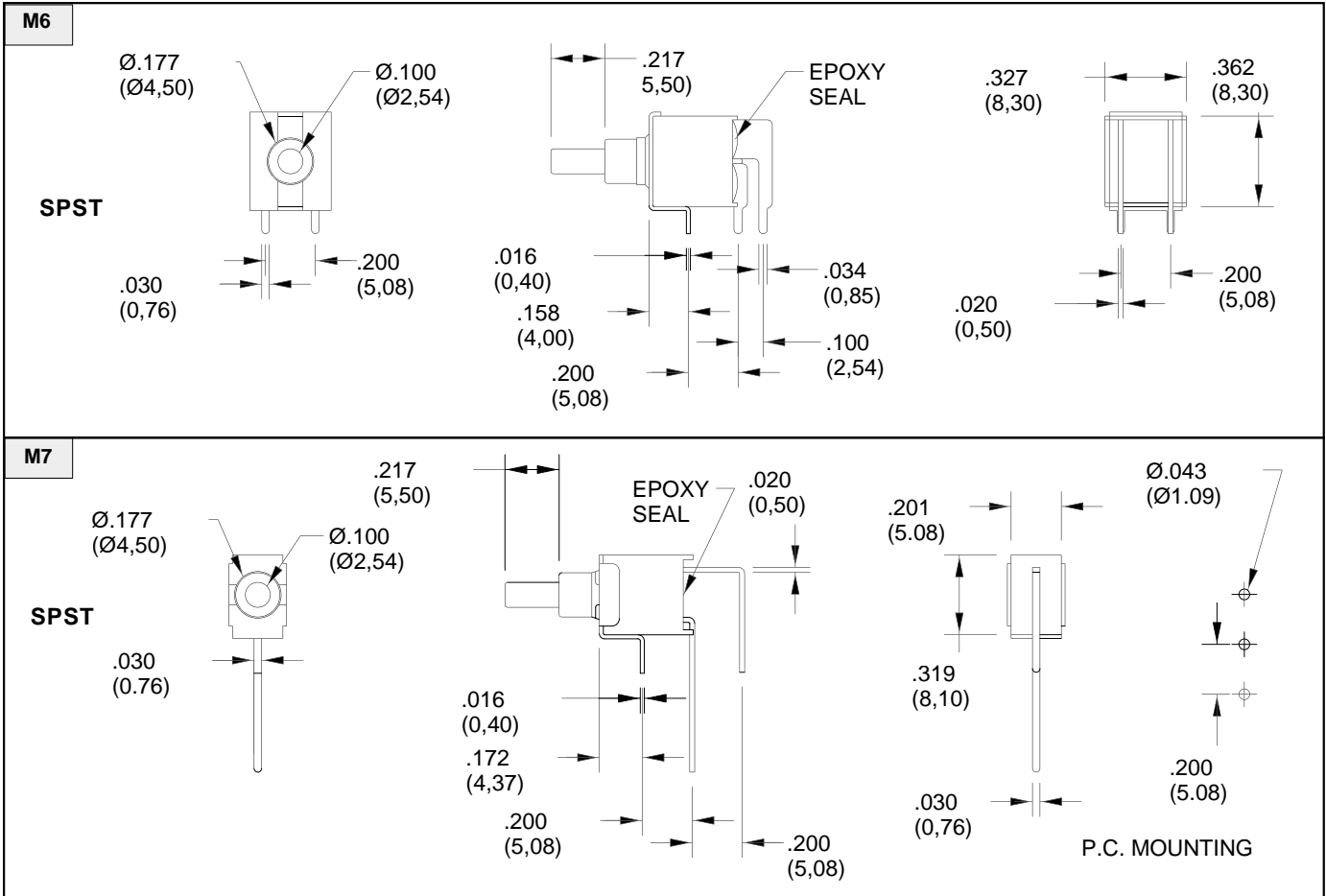

SERIES 38G

DIMENSIONS In inches (and millimeters)

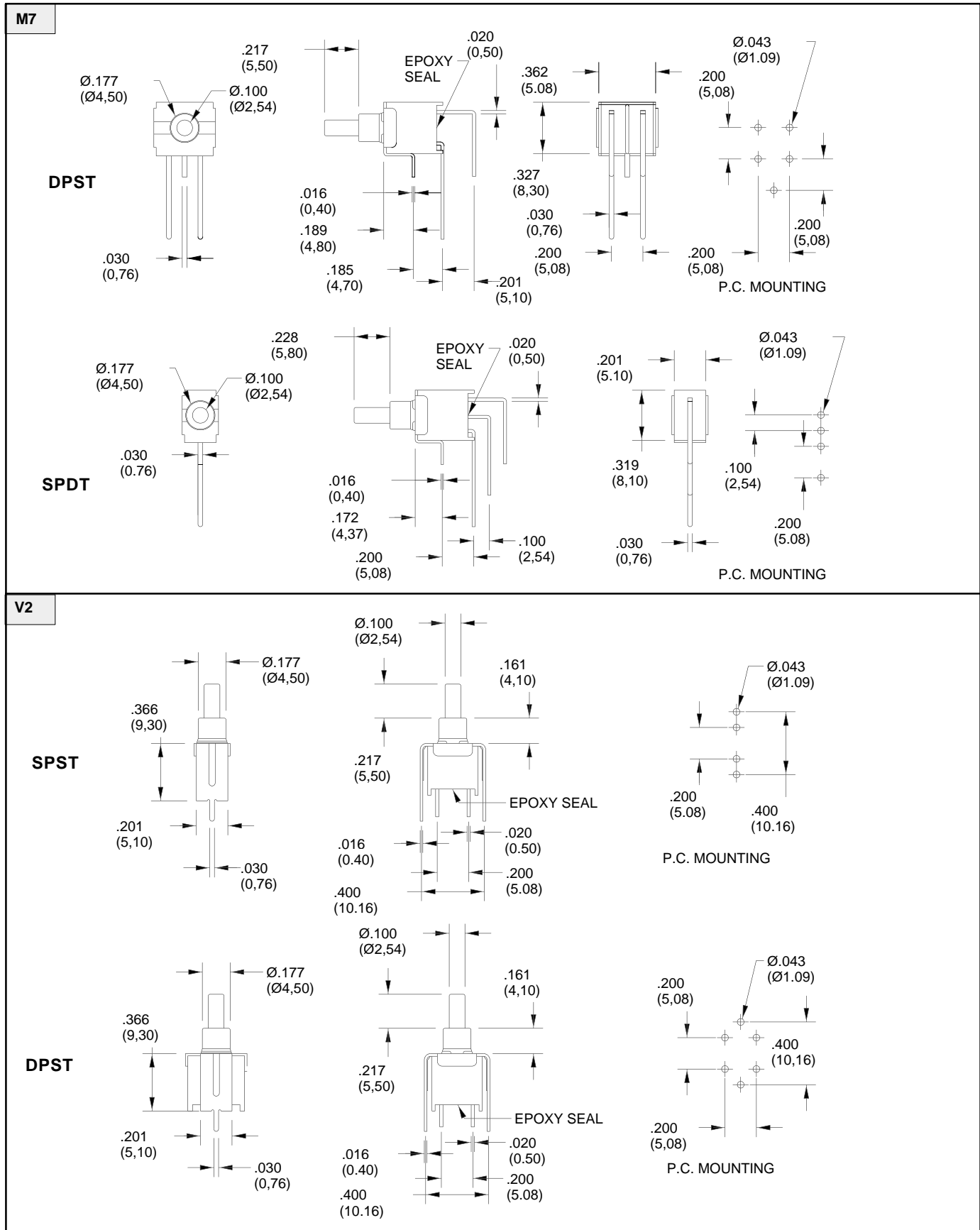

Pushbutton Switches

SERIES 38G

DIMENSIONS In inches (and millimeters)

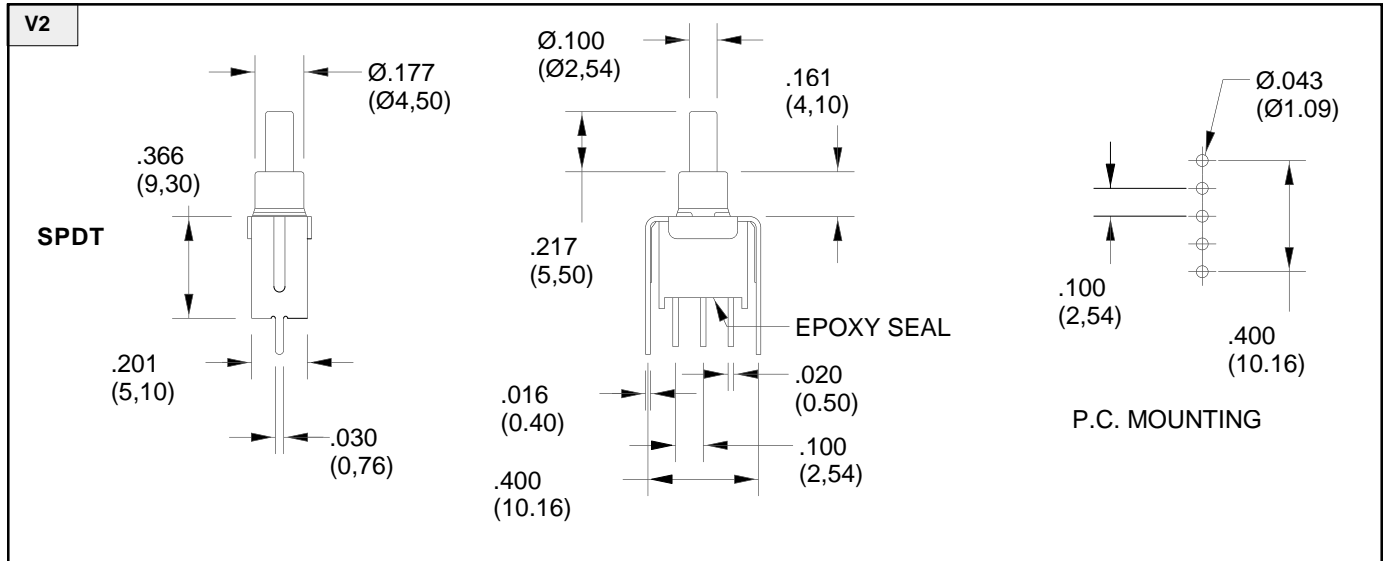

Snap-in Termination Options (Same P.C. mounting as V2, M6, M7 but with snap-in bracket)

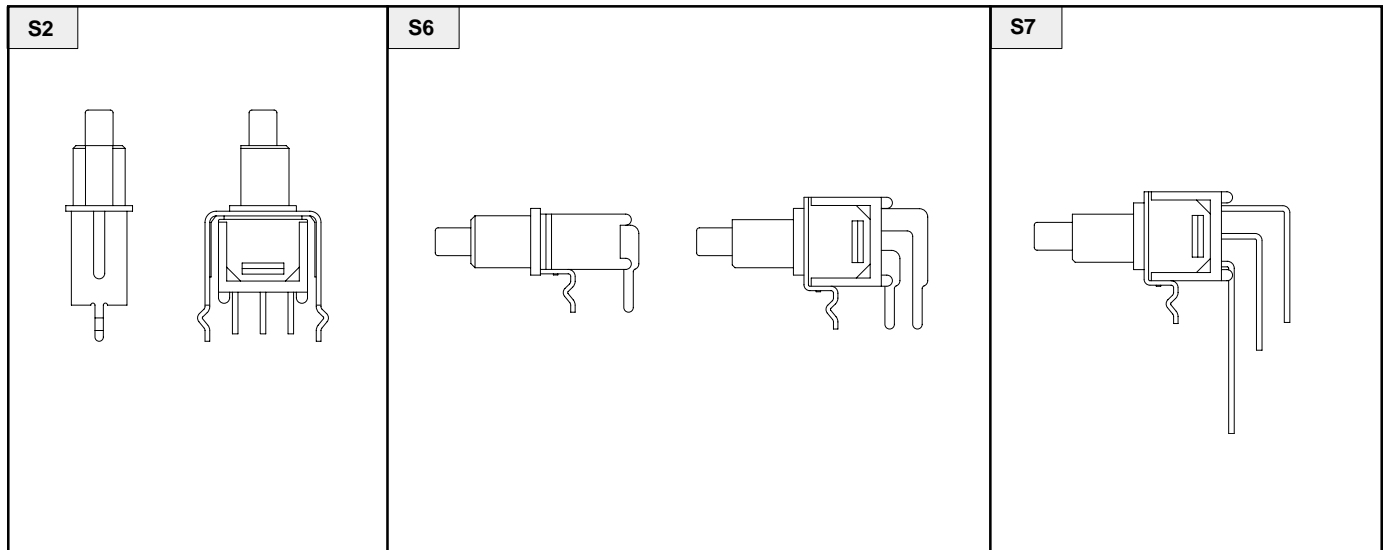

Circuitry

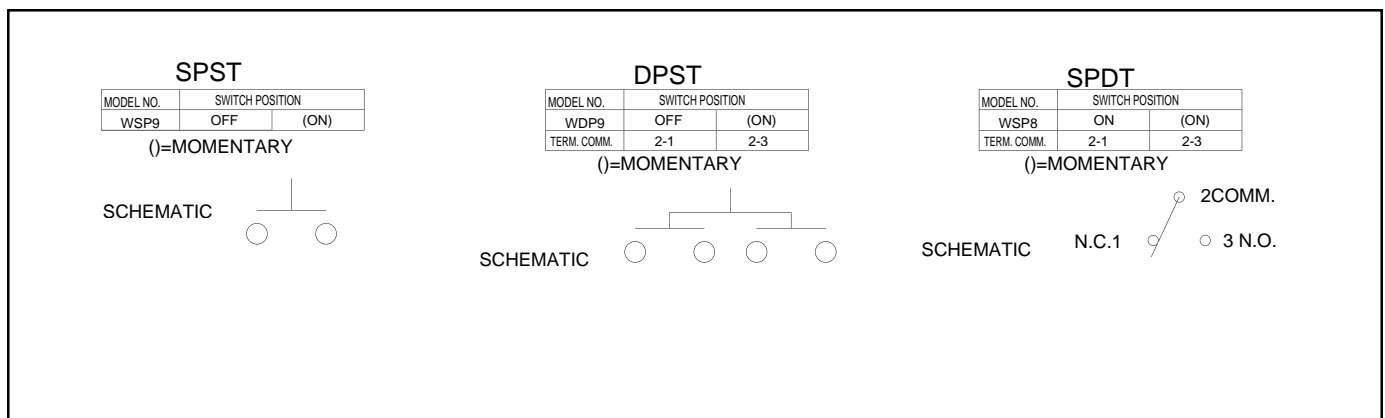

SERIES 38G

SPECIFICATIONS

Rating Criteria

Operating Life: 50,000 make-and-break cycles at full load

Contact Rating (resistive load):

R Option: 0.4 VA maximum at 20 Vac or Vdc maximum

G Option: 5A max at 125 Vac or 28 Vdc; 2A max at 250 Vac

Contact Resistance: Below 20 milliohms typical initial at 2-4 Vdc, 100 mA

Insulation Resistance: 1000 megaohms minimum

Voltage Breakdown: 1500 Vrms minimum at sea level

Operating Temperature: -30°C. to +85°C.

Materials and Finishes

Case: Glass filled Nylon 6/6 (UL 94V-0)

Plunger: Thermoplastic Polyester(UL 94V-0) (with internal o-ring seal)

Terminals: Copper alloy

Spring: Plated Music Wire

Contact System: Copper alloy

Switch Support: Brass, tin-plated

ORDERING INFORMATION

SERIES	MODEL NO.	TERMINATION	CONTACT	SEAL
38G	WSP8	M7	R	E
Subminiature Sealed Pushbutton Switches	Options: WSP8, WSP9, WDP9 (see models for switching positions)	Options: M6, M7, S2, S6, S7, V2 (see termination options)	R = Copper alloy, gold plate over nickel plate. G=Gold plate over silver plate	E = Epoxy seal

Pushbutton Switches