

8020 Series Snap-acting Momentary Pushbutton Switches



A

Pushbutton



Features/Benefits

- Positive tactile feel
- Multi-positions available
- Wide variety of termination options
- Epoxy terminal seal compatible with bottom wash cleaning
- RoHS compliant models available

Typical Applications

- Instrumentation
- Computer peripherals
- Telecommunications equipment



Models Available

Specifications

CONTACT RATING: B contact material (8X25 Models): 0.4 VA max. @ 20 V AC or DC maximum. G contact material (8X21, U8X1 Models): 1 AMP @ 120 V AC or 28 V DC or 0.4 VA max. @ 20 V AC or DC max. Note: Break-before-makecontacts. Multi-pole contacts do not make and break simultaneously. See page A-43 for additional ratings.

ELECTRICAL LIFE: 60,000 make-and-break cycles at full load.

CONTACT RESISTANCE: Below 50 mΩ typ. initial @ 2-4 V DC, 100 mA, for both silver and gold plated contacts.

INSULATION RESISTANCE: 10⁹Ω min.

DIELECTRIC STRENGTH: 1,000 Vrms min. @ sea level.

OPERATING TEMPERATURE: 8X2X MODELS: -30°C to 75°C. U8X1 MODELS: -30°C to 65°C.

CAP INSTALLATION FORCE: 10 lbs. max. permissible.

SOLDERABILITY: Per MIL-STD-202F method 208D, or EIA RS-186E method 9 (1 hour steam aging).

NOTE: Any models supplied with B, P, R, or G contact material are RoHS compliant.

NOTE: Specifications and materials listed above are for switches with standard options. For information on specific and custom switches, consult Customer Service Center.

Materials

CASE: Glass filled nylon 6/6 or diallyl phthalate (DAP), flame retardant (UL 94V-0).

PLUNGER: Glass filled nylon or glass filled polyester (PBT) (UL 94V-0).

CAP & FRAME: Nylon, black, standard.

BUSHING: Brass or zinc, nickel plated.

HOUSING: Stainless steel.

SWITCH SUPPORT: Brass or steel, matte-tin plated.

N.O. & N.C. CONTACTS: 8X21, U8X1 MODELS: G contact material: Coin silver, with gold plate over nickel plate. See page A-43 for additional contact materials. 8X25 MODELS: B contact material: Copper alloy, with gold plate over nickel plate. See page A-43 for additional contact materials.

COMMON CONTACT & ALL TERMINALS: Copper alloy, with gold plate over nickel plate.

TERMINAL SEAL: Epoxy. Refer to soldering and cleaning Technical Data Chapter.

HARDWARE: Nut & Locking Ring: Brass, nickel plated; Lockwasher: Steel, nickel plated.

Build-A-Switch

To order, simply select desired option from each category and place in the appropriate box. Available options are shown and described on pages A-30 thru A-45. For additional options not shown in catalog, consult Customer Service Center. All models have epoxy terminal seal and are compatible with all "bottom-wash" PCB cleaning methods.



Switch Function

- 8121** SPDT On-Mom. 1 Amp
- 8125** SPDT On-Mom. 0.4VA
- 8221** DPDT On-Mom. 1 Amp
- 8225** DPDT On-Mom. 0.4VA
- 8321** 3PDT On-Mom. 1 Amp
- 8325** 3PDT On-Mom. 0.4VA
- 8421** 4PDT On-Mom. 1 Amp
- 8425** 4PDT On-Mom. 0.4VA

Note: UL/CSA models available, see page A-30 and A-31.

Actuator or Plunger

- S** Plunger
- NONE** Snap-in
- J80** Snap-in
- J81** Snap-in w/frame
- J82** Snap-in w/frame for LED
- J83** Snap-in w/frame & flush cap
- J84** Snap-in w/frame for LED, flush cap
- J85** Snap-in w/frame & LED
- J95** PC w/V-bracket & LED
- L** Plunger
- M** Snap-fitting plunger

Bushing

- D9** .280" high, keyway
- H** .250" high, flat
- NONE** No bushing choice required
- D** .280" high, keyway
- D2** .288" high, flat
- D3** .180" high
- D8** .288" high, flat
- H9** .250" high, flat, hi torque
- Y** .350" high, keyway
- Y3** 6.35mm high, keyway, hi torque
- Y4** .378" high, flat, hi torque
- Y9** .350" high, keyway

Contact Material

- B** Gold
- P** Gold, matte-tin
- G** Gold over silver
- R** Gold over silver, matte-tin

Seal

- E** Epoxy
- I** Epoxy potted base

Cap Color

- 2** Black
- NONE** Models without caps
- 1** White
- 3** Red
- 4** Orange
- 5** Yellow
- 6** Green
- 7** Blue
- 9** Gray

Frame Color

- 2** Black
- NONE** Models without frame
- 1** White
- 3** Red
- 5** Yellow
- 6** Green
- 9** Gray

LED Color

- 3** Red
- NONE** Models without LED
- 5** Yellow
- 6** Green

Terminations

- A** Right angle, PC thru-hole
- AV2** Vertical right angle, PC thru-hole
- C** PC Thru-hole
- Z** Solder lug
- A2** Right angle, PC thru-hole
- A3** Right angle, snap-in, PC thru-hole
- A4** Right angle, PC thru-hole, reversed terminals
- A6** Right angle, PC thru-hole
- AV** Vertical right angle, PC thru-hole
- AV1** Vertical right angle, PC thru-hole
- AV3** Vertical right angle, snap-in, PC thru-hole
- R** Right angle with PCB
- R2** Right angle with PCB, reversed terminals
- V2** .555" high, V-bracket
- V3** .460" high, V-bracket
- V4** .630" high, V-bracket
- V6** .460" high, V-bracket
- V7** .630" high, V-bracket
- V8** .953" high, V-bracket
- V9** 1.150" high, V-bracket
- V31** .460" high, snap-in V-bracket
- V61** .460" high, snap-in V-bracket
- W** .750" long, wire wrap
- W1** .964" long, wire wrap
- W3** .425" long, wire wrap
- W4** 1.062" long, wire wrap
- Z3** Quick connect



Dimensions are shown: Inches (mm)
Specifications and dimensions subject to change



8020 Series Snap-acting Momentary Pushbutton Switches

SWITCH FUNCTION

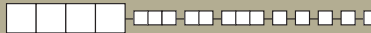

Pushbutton A

| NO. POLES | MODEL NO. | UL/CSA* MODEL NO. | SWITCH FUNCTION | | CONNECTED TERMINALS | | SCHEMATIC |
|--|-----------|-------------------|-----------------|--------|---------------------|-------------|-----------|
| | | | POS. 1 | POS. 2 | POS. 1 | POS. 2 | |
| SP | 8121 | U811 | ON | MOM. | 1-3 | 1-2 | |
| | 8125 | | ON | MOM. | | | |
| <p>SPDT</p> <p>Part number shown: 8121SHZGE</p> | | | | | | | |
| DP | 8221 | U821 | ON | MOM. | 1-3,4-6 | 1-2,4-5 | |
| | 8225 | | ON | MOM. | | | |
| <p>DPDT</p> <p>Part number shown: 8221SHZGE</p> | | | | | | | |
| 3P | 8321 | U831 | ON | MOM. | 1-3,4-6,7-9 | 1-2,4-5,7-8 | |
| | 8325 | | ON | MOM. | | | |
| <p>3PDT</p> <p>Part number shown: 8321SHZGE</p> | | | | | | | |

MOM. = Momentary

*U811 thru U841 model numbers with all options (except R, R2 terminations) when ordered with G or R contact material.

8X25 models must be ordered with B or P contact material.

8X21 and U8X1 models must be ordered with G or R contact material.



Dimensions are shown: Inches (mm)
Specifications and dimensions subject to change

www.ck-components.com

8020 Series Snap-acting Momentary Pushbutton Switches



A

Pushbutton

SWITCH FUNCTION

| NO. POLES | MODEL NO. | UL/CSA* MODEL NO. | SWITCH FUNCTION | | CONNECTED TERMINALS | | SCHEMATIC |
|-----------|-----------|-------------------|-----------------|--------|---------------------|-------------------|-----------|
| | | | POS. 1 | POS. 2 | POS. 1 | POS. 2 | |
| 4P | 8421 | U841 | ON | MOM. | 1-3,4-6,7-9,10-12 | 1-2,4-5,7-8,10-11 | |
| | 8425 | | ON | MOM. | | | |

4PDT

Part number shown: 8421SHZGE

Terminal Nos. For Reference Only

MOM. = Momentary

* U811 thru U841 model numbers with all options (except R, R2 terminations) when ordered with G or R contact material.

8X25 models must be ordered with B or P contact material.

8X21 and U8X1 models must be ordered with G or R contact material.

ACTUATOR—SNAP-IN FRONT MOUNT

| OPTION CODE | CAP AND FRAME COLOR |
|-------------|-----------------------------|
| 2 | BLACK |
| NONE | No Frame Color (J80 option) |
| 1 | WHITE |
| 3 | RED |
| 4 | ORANGE |
| 5 | YELLOW |
| 6 | GREEN |
| 7 | BLUE |
| 9 | GRAY |

Other colors available, consult Customer Service Center. Cap and Frame Finish: matte.

NOTE: Caps and frames available separately, see pages A-44 and A-45.

J80 SNAP-IN

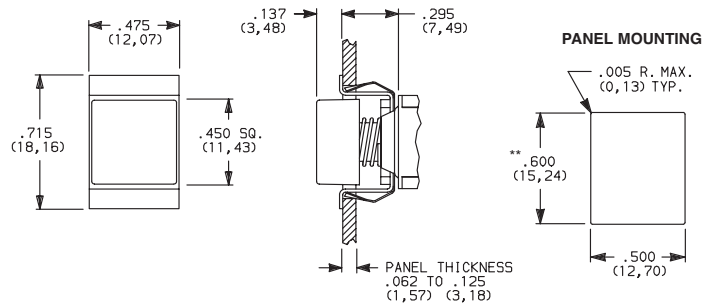

NOTE: No frame color choice required.

** Increase this dim. to .620/.625 (15,75/15,88) for .091/.125 (2,31/3,18) thk. panels.

J81 SNAP-IN WITH FRAME

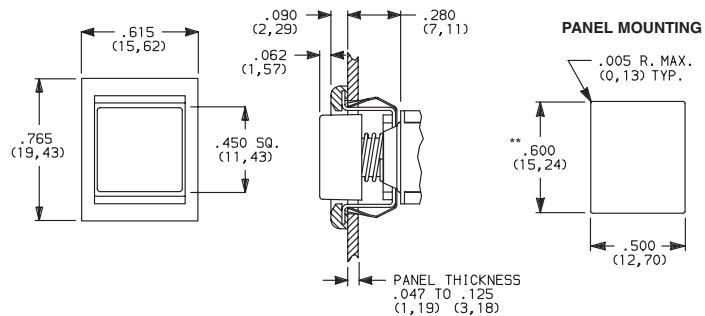

NOTE: Available with C, W-W4, Z or Z3 terminations and SPDT and DPDT models only.

** Increase this dim. to .620/.625 (15,75/15,88) for .091/.125 (2,31/3,18) thk. panels.



Dimensions are shown: Inches (mm)
 Specifications and dimensions subject to change





A

Pushbutton

8020 Series Snap-acting Momentary Pushbutton Switches

ACTUATOR—SNAP-IN FRONT MOUNT



J83 SNAP-IN WITH FRAME AND FLUSH CAP

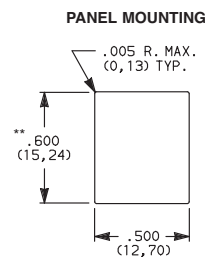
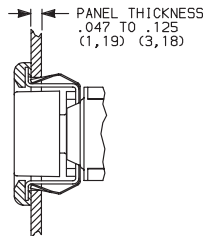
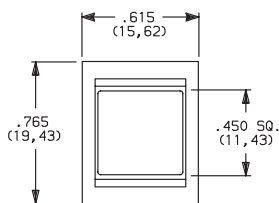

J82 SNAP-IN WITH FRAME FOR LED

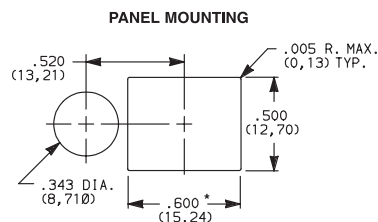
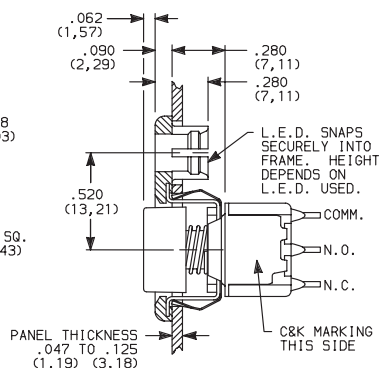
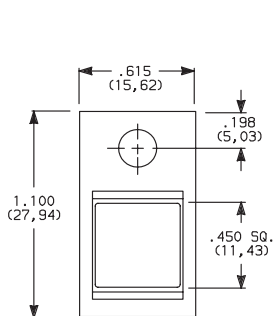

* Increase this dim. to .620/.625 (15,75/15,88) for .091/.125 (2,31/3,18) thk. panels.

LED not included.
For LED information, see page A-45.

J84 SNAP-IN WITH FRAME FOR LED, FLUSH CAP

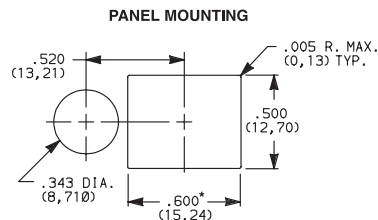
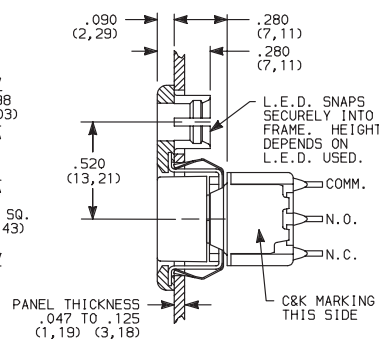
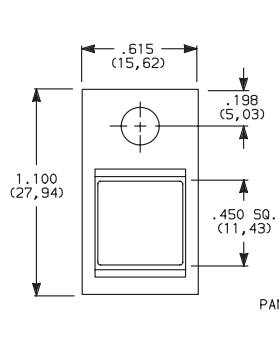

* Increase this dim. to .620/.625 (15,75/15,88) for .091/.125 (2,31/3,18) thk. panels.

LED not included.
For LED information, see page A-45.

| OPTION CODE | CAP AND FRAME COLOR |
|-------------|---------------------|
| 2 | BLACK |
| 1 | WHITE |
| 3 | RED |
| 4 | ORANGE |
| 5 | YELLOW |
| 6 | GREEN |
| 7 | BLUE |
| 9 | GRAY |

Other colors available, consult Customer Service Center.
Cap and Frame Finish: matte.

Available with C, W-W4, Z or Z3 terminations and SPDT and DPDT models only.

NOTE: Caps and frames available separately, see pages A-44 and A-45.

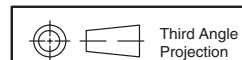

Third Angle Projection

Dimensions are shown: Inches (mm)
Specifications and dimensions subject to change

www.ck-components.com



8020 Series Snap-acting Momentary Pushbutton Switches



A

Pushbutton

ACTUATOR—SNAP-IN FRONT MOUNT

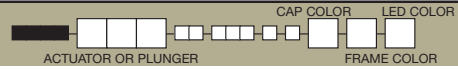

J85 SNAP-IN WITH FRAME AND LED

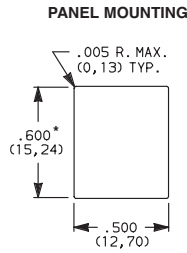
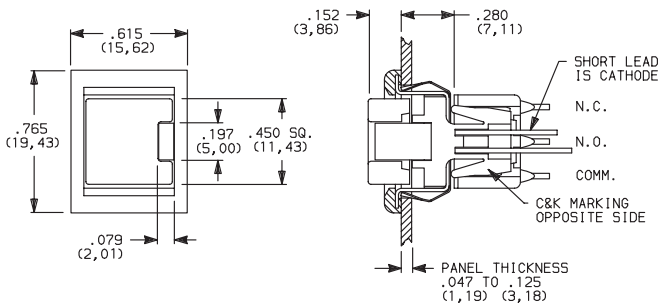

* Increase this dim. to .620/.625 (15,75/15,88) for .091/.125 (2,31/3,18) thk. panels.



8121J85ZGE223 SPST

Available with C, W-W4, Z or Z3 terminations and SPDT models only. For LED information see page A-45.

NOTE: Caps & frames available separately, see pages A-44 and A-45.

| OPTION CODE | CAP AND FRAME COLOR |
|-------------|---------------------|
| 2 | BLACK |
| 1 | WHITE |
| 3 | RED |
| 4 | ORANGE |
| 5 | YELLOW |
| 6 | GREEN |
| 7 | BLUE |
| 9 | GRAY |

| OPTION CODE | LED COLOR |
|-------------|-----------|
| 3 | RED |
| 5 | YELLOW |
| 6 | GREEN |

For LED information see page A-45.

ACTUATOR—PC MOUNT

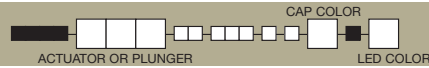

J95 PC WITH V-BRACKET AND LED

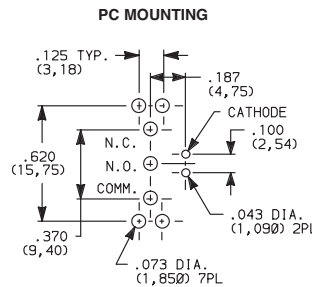
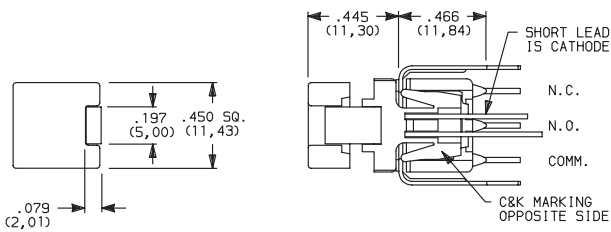

8121J95V3GE23 SPST

| OPTION CODE | CAP AND FRAME COLOR |
|-------------|---------------------|
| 2 | BLACK |
| 1 | WHITE |
| 3 | RED |
| 4 | ORANGE |
| 5 | YELLOW |
| 6 | GREEN |
| 7 | BLUE |
| 9 | GRAY |

| OPTION CODE | LED COLOR |
|-------------|-----------|
| 3 | RED |
| 5 | YELLOW |
| 6 | GREEN |

For LED information see page A-45.

NOTE: Caps available separately, see page A-44. Available with V3 terminations and SPDT models only.



Third Angle Projection
Dimensions are shown: Inches (mm)
Specifications and dimensions subject to change





8020 Series Snap-acting Momentary Pushbutton Switches

Pushbutton A

PLUNGER

ACTUATOR OR PLUNGER

S PLUNGER

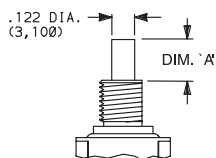

NONE NO PLUNGER CHOICE REQUIRED (JXX ACTUATORS)

| AVAILABLE BUSHINGS | DIM. 'A' FOR C, W-W4, Z & Z3 TERMINATIONS | DIM. 'A' FOR A, A2, A3, A4, A6, AV-A3, R & R2 TERMINATIONS | DIM. 'A' FOR V3-V61 TERMINATIONS |
|--------------------|---|--|----------------------------------|
| D, D9 | .244 (6,20) | .228 (5,79) | .224 (5,69) |
| H, H9 | .218 (5,54) | .202 (5,13) | .198 (5,03) |
| Y, Y9 | .203 (5,16) | .187 (4,75) | .183 (4,65) |
| Y3 | (5,54) | (5,13) | (5,03) |
| Y4 | .185 (4,70) | .169 (4,29) | .165 (4,19) |
| D2, D8 | N/A | .232 (5,89) | .228 (5,79) |
| D3 | N/A | .162 (4,11) | .158 (4,01) |

L PLUNGER

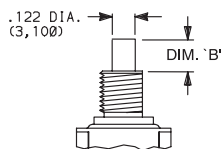

| AVAILABLE BUSHINGS | DIM. 'B' FOR C, W-W4, Z & Z3 TERMINATIONS | DIM. 'B' FOR A, A2, A3, A4, A6, AV-A3, R & R2 TERMINATIONS | DIM. 'B' FOR V3-V61 TERMINATIONS |
|--------------------|---|--|----------------------------------|
| Y, Y9 | .178 (4,52) | .162 (4,11) | .158 (4,01) |
| Y4 | .090 (2,29) | .074 (1,88) | .070 (1,78) |

M SNAP-FITTING PLUNGER

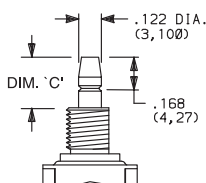

| AVAILABLE BUSHINGS | DIM. 'C' FOR C, W-W4, Z & Z3 TERMINATIONS | DIM. 'C' FOR A, A2, A3, A4, A6, AV-A3, R & R2 TERMINATIONS | DIM. 'C' FOR V3-V61 TERMINATIONS |
|--------------------|---|--|----------------------------------|
| D, D9 | .297 (7,54) | .281 (7,14) | .277 (7,04) |
| H, H9 | .267 (6,78) | .251 (6,38) | .247 (6,27) |
| Y, Y9 | .259 (6,58) | .243 (6,17) | .239 (6,07) |
| Y3 | (6,78) | (6,37) | (6,27) |
| Y4 | .259 (6,58) | .243 (6,17) | .239 (6,07) |
| D2, D8 | N/A | .273 (6,93) | .269 (6,83) |
| D3 | N/A | .361 (9,17) | .357 (9,07) |

N/A = NOT AVAILABLE

NOTE: When selecting plunger option, bushing selection must also be made, see next page. No plunger option is required when any JXX actuator option is selected. Additional plunger lengths are available on SPDT and DPDT models, consult Customer Service Center. Not all plunger lengths sufficient for use with caps, see page A-44.

BUSHING

NONE NO BUSHING CHOICE REQUIRED (JXX ACTUATORS)

D .280" HIGH THREADED, KEYWAY
D9 .280" HIGH UNTHREADED, KEYWAY

H .250" HIGH THREADED, FLAT
H9 .250" HIGH UNTHREADED, FLAT

Y .350" HIGH THREADED, KEYWAY
Y9 .350" HIGH UNTHREADED, KEYWAY

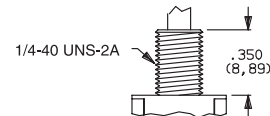
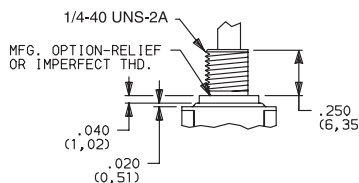
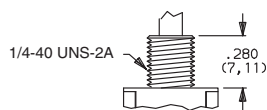
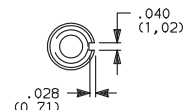
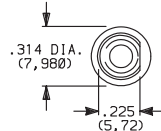
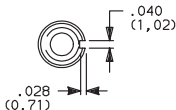

D9 bushing standard with A-A6, R, R2 AV-A3 terminations.

H bushing standard with C, W-W4, Z or Z3 terminations. H, H9 bushings not available on single pole models with A3-A6, R, R2 terminations.

Will withstand 12 in./lbs. of torque with no distortion.

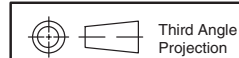

Dimensions are shown: Inches (mm)
 Specifications and dimensions subject to change



www.ck-components.com

8020 Series Snap-acting Momentary Pushbutton Switches



A

Pushbutton

BUSHING

Y3 6.35mm THREADED, KEYWAY

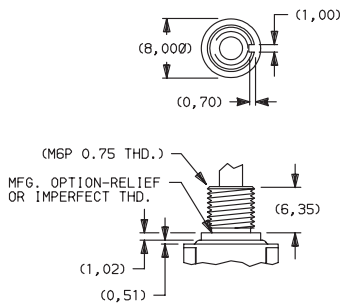

Y4 .378" HIGH THREADED, FLAT

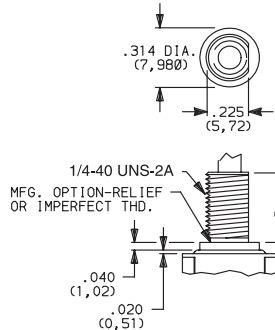

D2 .288" HIGH THREADED, FLAT

D8 .288" HIGH UNTHREADED, FLAT

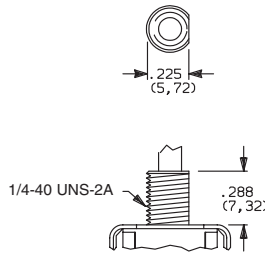

D3 .180" HIGH UNTHREADED

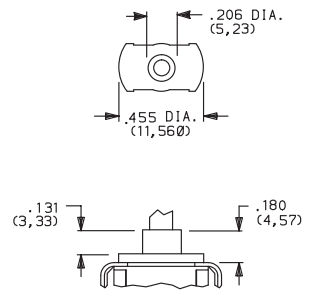

Y3 & Y4 bushings not available on single pole models with A3-A6, R, R2 terminations. Will withstand 12 in./lbs. of torque with no distortion.

D2, D8 bushings not available with C, W-W4, Z, Z3 terminations.

D3 bushing available with A, A2, A3, AV, AV2, AV3 and V2-V61 terminations only.

NOTE: No bushing option choice required when JXX actuator option is selected. When selecting bushing option, plunger selection must also be made, see previous page. Plunger lengths vary with bushing and termination options selected.

PANEL MOUNTING

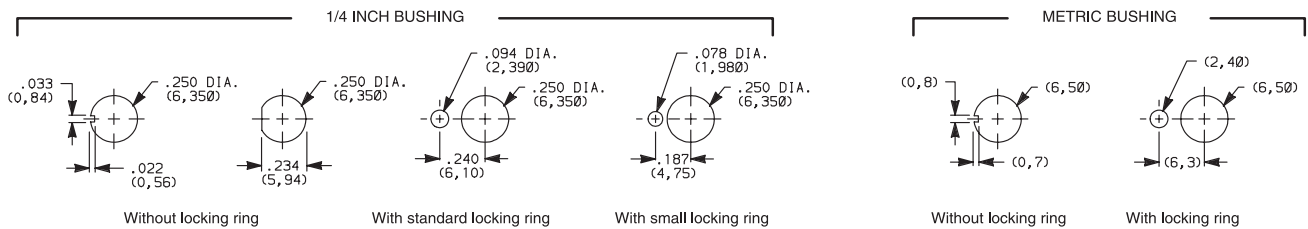

NOTE: Two mounting nuts, locking ring and lockwasher supplied standard with threaded bushings. Optional mounting nut and locking ring styles available, see section "Technical Data and Additional Hardware".

TERMINATIONS

Z SOLDER LUG

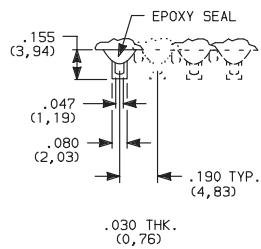

SPDT thru 4PDT

Not available with J95 actuator, P or R contact material.

C PC THRU-HOLE

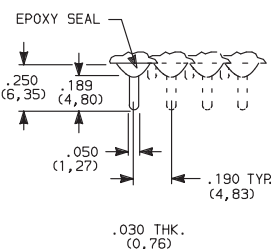

SPDT thru 4PDT

Not available with J95 actuator option.

PC MOUNTING

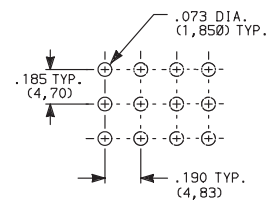

Z3 QUICK CONNECT

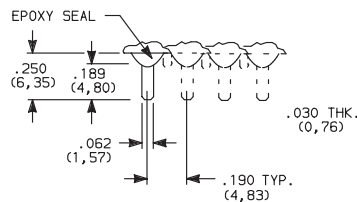

SPDT thru 4PDT

Not available with J95 actuator, P or R contact material. Mating quick connector available, order part number 530100000, page A-44.

W W1, W3, W4 WIRE WRAP

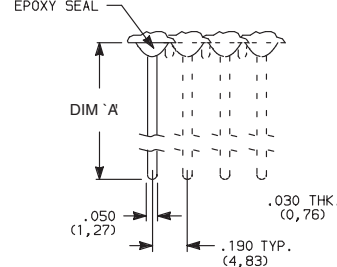

SPDT thru 4PDT

| OPTION CODE | DIM 'A' |
|-------------|---------------|
| W | .750 (19,05) |
| W1 | .964 (24,49) |
| W3 | .425 (10,80) |
| W4 | 1.062 (26,97) |

Not available with J95 actuator option.



Third Angle Projection



Dimensions are shown: Inches (mm)
Specifications and dimensions subject to change

www.ck-components.com



8020 Series Snap-acting Momentary Pushbutton Switches

TERMINATIONS



Pushbutton

A

A RIGHT ANGLE, PC THRU-HOLE



8121SD9AGE
SPDT

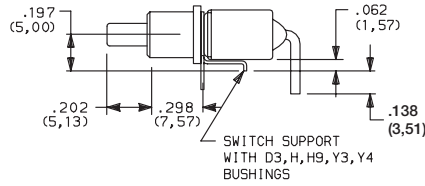
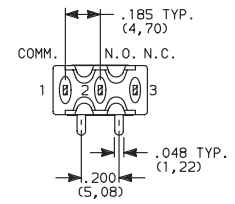
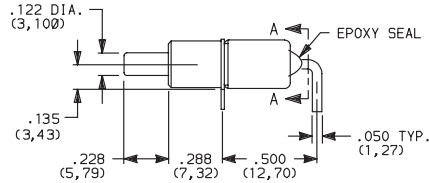
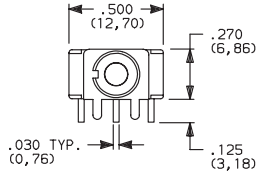

Part Number 8121SH9AGE

SECTION A-A

Terminal Nos.
For Reference Only.

A3 RIGHT ANGLE, SNAP-IN, PC THRU-HOLE

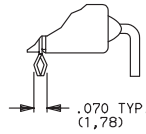
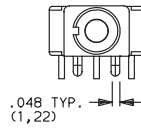

PC MOUNTING

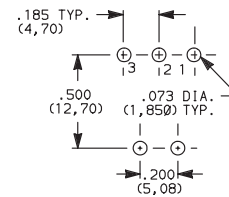

Not available with JXX actuators and I seal.
Terminal bend radii and lead-in manufacturing option.

A RIGHT ANGLE, PC THRU-HOLE



8221SD9AGE
DPDT

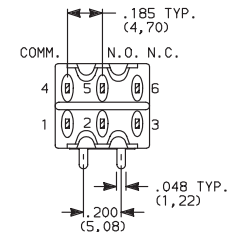
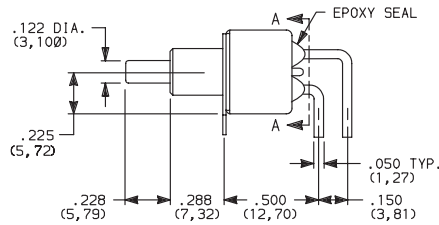
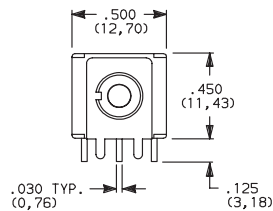

SECTION A-A

A3 RIGHT ANGLE, SNAP-IN, PC THRU-HOLE

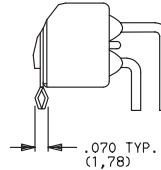
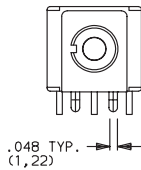

PC MOUNTING

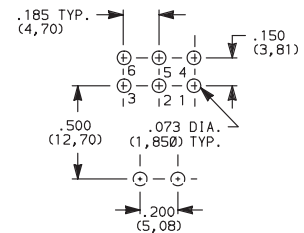

Not available with JXX actuators and I seal option.
Terminal bend radii and lead-in manufacturing option.

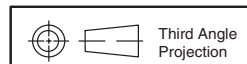

Dimensions are shown: Inches (mm)
Specifications and dimensions subject to change



www.ck-components.com

8020 Series Snap-acting Momentary Pushbutton Switches



A

Pushbutton

TERMINATIONS

A RIGHT ANGLE, PC THRU-HOLE

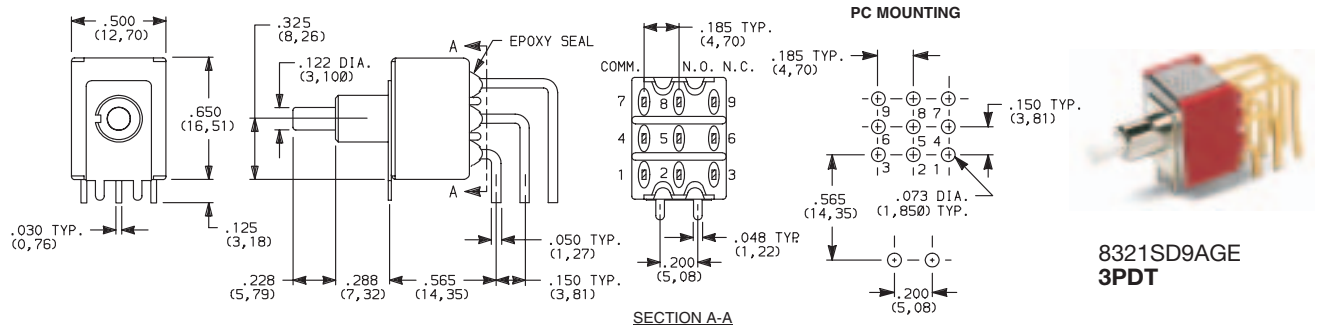

Not available with JXX actuators and I seal option.
Terminal bend radii and lead-in manufacturing option.

A2 RIGHT ANGLE, PC THRU-HOLE

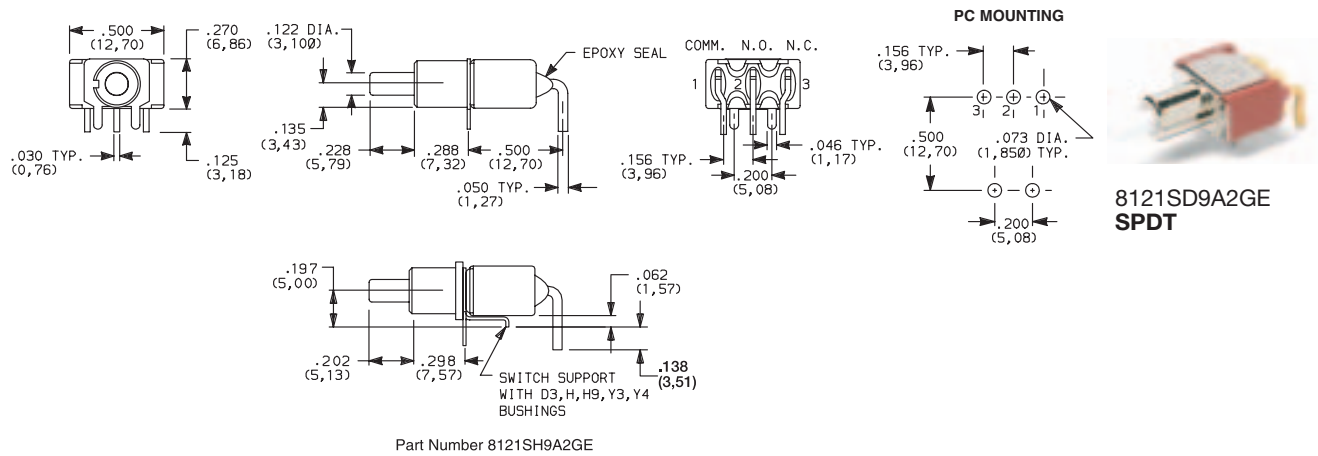

Not available with JXX actuators, I seal option.
Terminal bend radii and lead-in manufacturing option.

A4 RIGHT ANGLE, PC THRU-HOLE, REVERSED TERMINALS

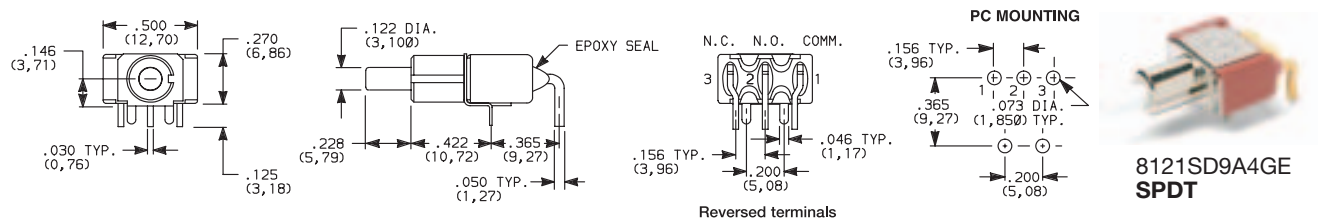

Not available with JXX actuators, D3, H, H9, Y3, Y4 bushings and I seal.
Terminal bend radii and lead-in manufacturing option.

The A4 and R2 termination options are functionally identical and fit the same PC mounting pattern. The switches, however, are shifted relative to the mounting holes. The PC pattern must clear the switch support legs. Unlike the R2, the A4 option is available with UL/CSA.



Dimensions are shown: Inches (mm)
Specifications and dimensions subject to change





8020 Series Snap-acting Momentary Pushbutton Switches

TERMINATIONS



Pushbutton

A6 RIGHT ANGLE, PC THRU-HOLE



8121SD9A6GE SPDT

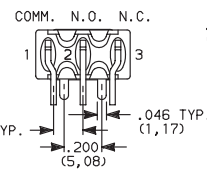
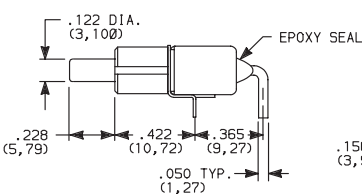
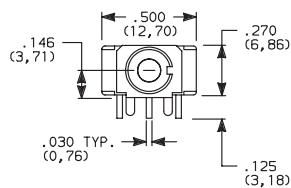

PC MOUNTING

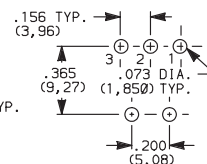

The A6 and R termination options are functionally identical and fit the same PC mounting pattern. The switches, however, are shifted relative to the mounting holes. The PC pattern must clear the switch support legs. Unlike the R, the A6 option is available with UL/CSA.

Not available with JXX actuators, D3, H, H9, Y3, Y4 bushings and I seal. Terminal bend radii and lead-in manufacturing option.

R RIGHT ANGLE WITH PCB



8121SD9RGE SPDT

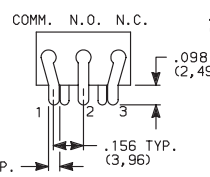
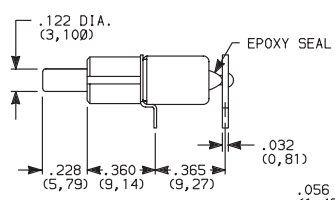
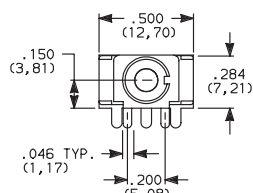

PC MOUNTING

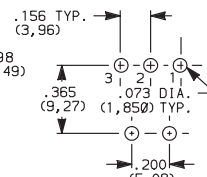

Not available with JXX actuators, D3, H, H9, Y3, Y4 bushings, I seal option. R termination not UL/CSA approved.

R2 RIGHT ANGLE WITH PCB, REVERSED TERMINALS



8121SD9R2GE SPDT

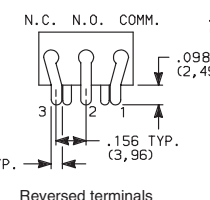
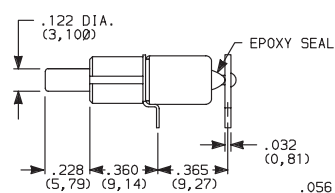
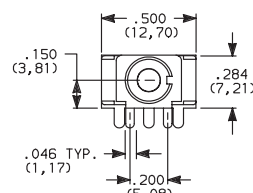

PC MOUNTING

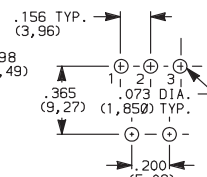

Not available with JXX actuators, D3, H, H9, Y3, Y4 bushings, I seal option. R2 termination not UL/CSA approved.

AV VERTICAL RIGHT ANGLE, PC THRU-HOLE, .100" PITCH



8121SD9AVGE SPDT

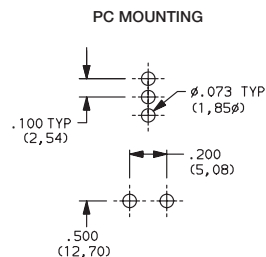
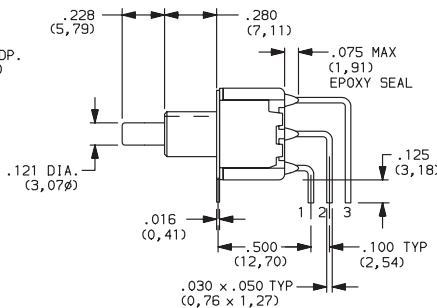
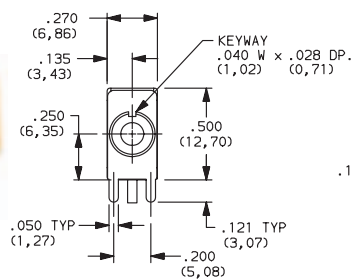

Dimensions are shown: Inches (mm)
Specifications and dimensions subject to change



www.ck-components.com

8020 Series Snap-acting Momentary Pushbutton Switches



A

Pushbutton

TERMINATIONS



AV2 VERTICAL RIGHT ANGLE, PC THRU-HOLE, .150" PITCH

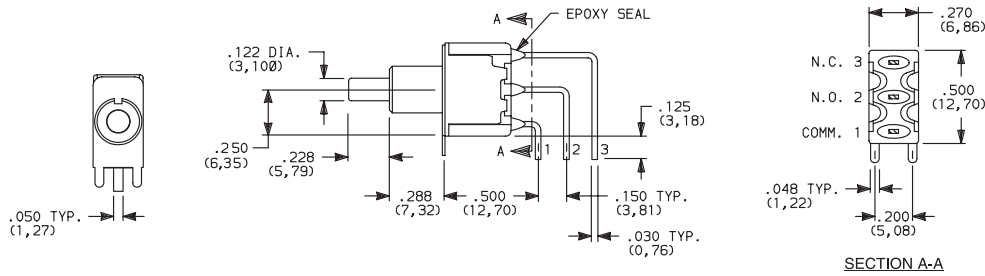

8121SD9AV2GE SPDT

AV3 VERTICAL RIGHT ANGLE, SNAP-IN, PC THRU-HOLE, .150" PITCH

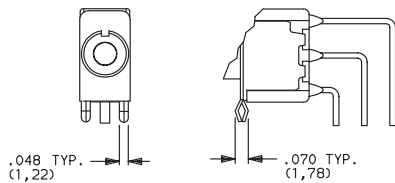

AV1 VERTICAL RIGHT ANGLE, EXTENDED, PC THRU-HOLE, .150" PITCH

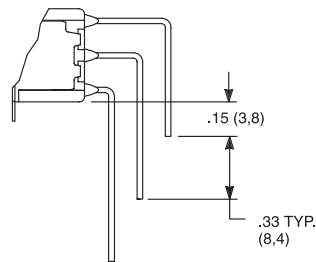

PC MOUNTING

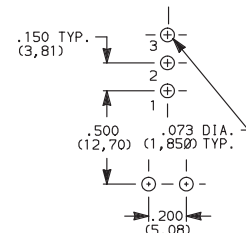

Not available with JXX actuators and I seal.
Terminal bend radii and lead-in manufacturing option.

AV2 VERTICAL RIGHT ANGLE, PC THRU-HOLE, .150" PITCH

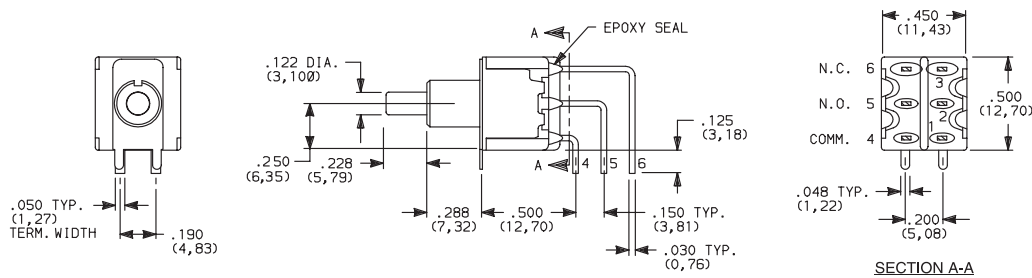

8221SD9AV2GE DPDT

AV3 VERTICAL RIGHT ANGLE, SNAP-IN, PC THRU-HOLE, .150" PITCH

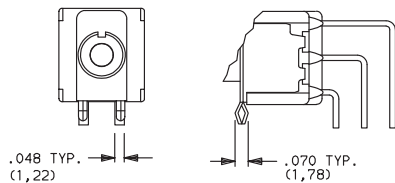

AV1 VERTICAL RIGHT ANGLE, EXTENDED, PC THRU-HOLE, .150" PITCH

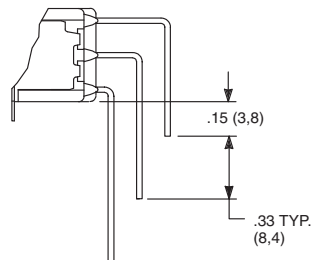

PC MOUNTING

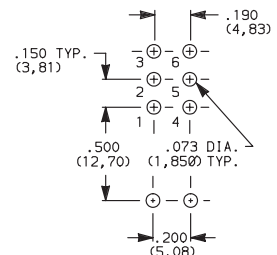

Not available with JXX actuators and I seal.
Terminal bend radii and lead-in manufacturing option.

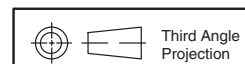

Dimensions are shown: Inches (mm)
Specifications and dimensions subject to change



www.ck-components.com



8020 Series Snap-acting Momentary Pushbutton Switches

TERMINATIONS



AV2 VERTICAL RIGHT ANGLE, PC THRU-HOLE, 150° PITCH



8321SD9AV2GE
3PDT

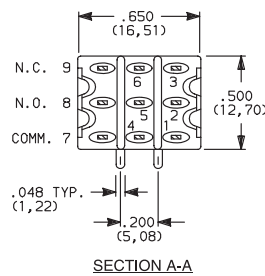
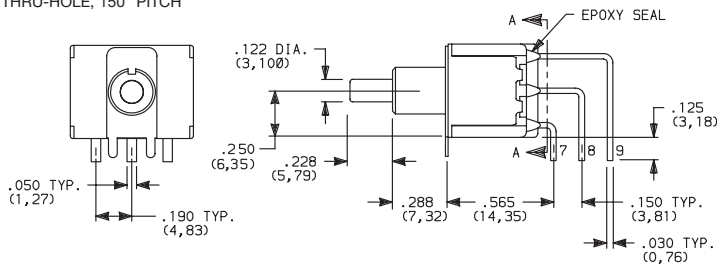

AV3 VERTICAL RIGHT ANGLE, SNAP-IN, PC THRU-HOLE, .150° PITCH

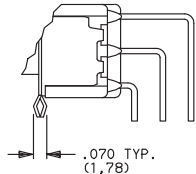
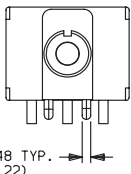

AV1 VERTICAL RIGHT ANGLE, EXTENDED, PC THRU-HOLE, .150° PITCH

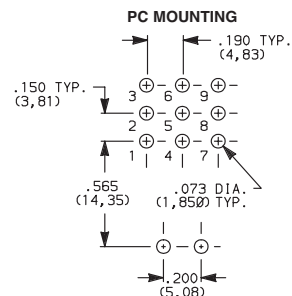
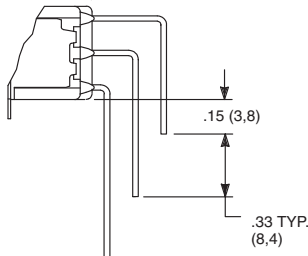

Not available with JXX actuators and I seal.
Terminal bend radii and lead-in manufacturing option.

AV2 VERTICAL RIGHT ANGLE, PC THRU-HOLE, 150° PITCH



8421SD9AV2GE
4PDT

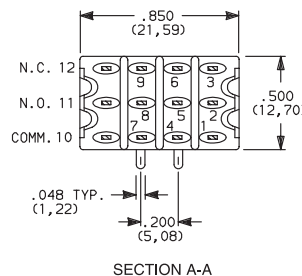
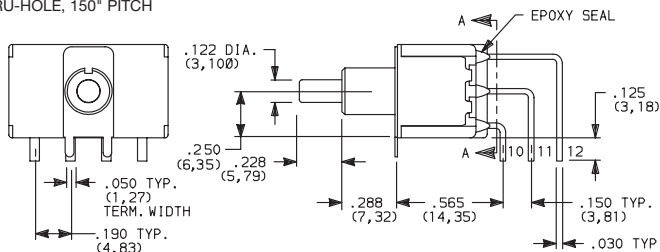

AV3 VERTICAL RIGHT ANGLE, SNAP-IN, PC THRU-HOLE, .150° PITCH

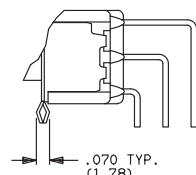
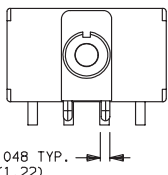

AV1 VERTICAL RIGHT ANGLE, EXTENDED, PC THRU-HOLE, .150° PITCH

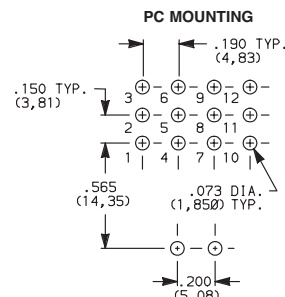
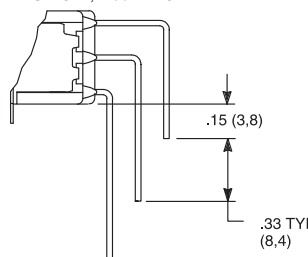

Not available with JXX actuators and I seal.
Terminal bend radii and lead-in manufacturing option.

V2, V6, V7, V8 VERTICAL MOUNT, V-BRACKET

V61 VERTICAL MOUNT, V-BRACKET, SNAP-IN



8121SD3_GE
SPDT

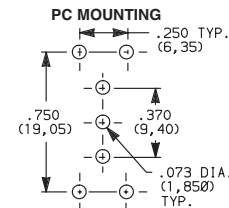
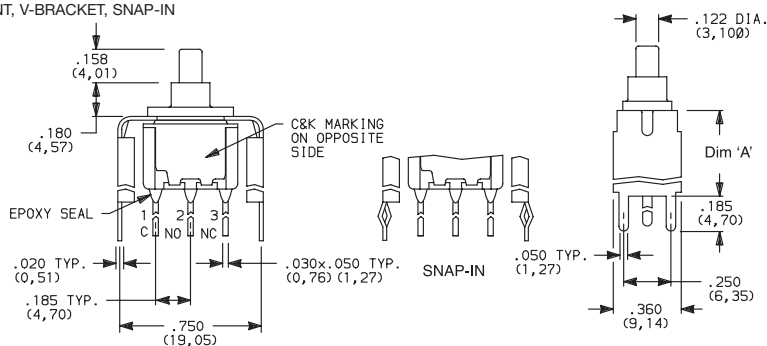

| OPTION CODE | DIM 'A' |
|----------------|--------------|
| V2 | .555 (14,10) |
| V6, V61 | .460 (11,68) |
| V7 | .630 (16,00) |
| V8 | .953 (24,21) |

Not available with JXX actuators and I seal.

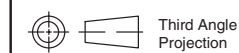

Dimensions are shown: Inches (mm)
Specifications and dimensions subject to change

www.ck-components.com

8020 Series Snap-acting Momentary Pushbutton Switches



A

Pushbutton

TERMINATIONS



V2, V6, V7, V8 VERTICAL MOUNT, V-BRACKET

V61 VERTICAL MOUNT, V-BRACKET, SNAP-IN

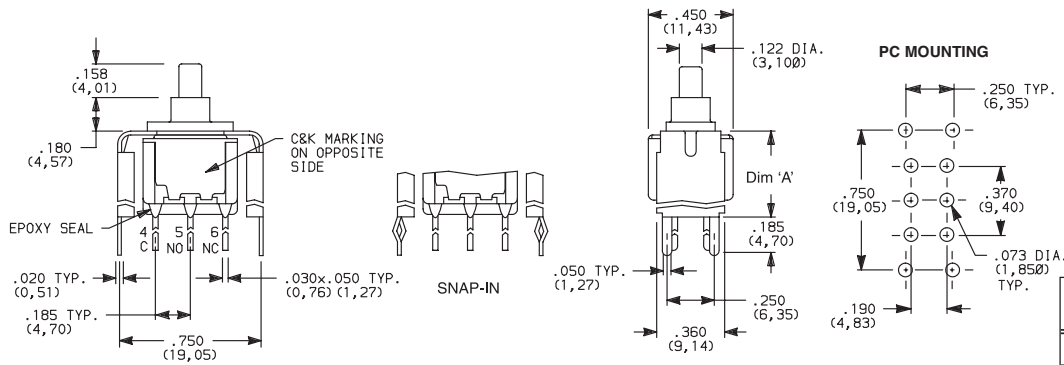

8221SD3_GE DPDT

| OPTION CODE | DIM 'A' |
|-------------|--------------|
| V2 | .555 (14,10) |
| V6, V61 | .460 (11,68) |
| V7 | .630 (16,00) |
| V8 | .953 (24,21) |

Not available with JXX actuators and I seal.

V2, V7, V8 VERTICAL MOUNT, V-BRACKET

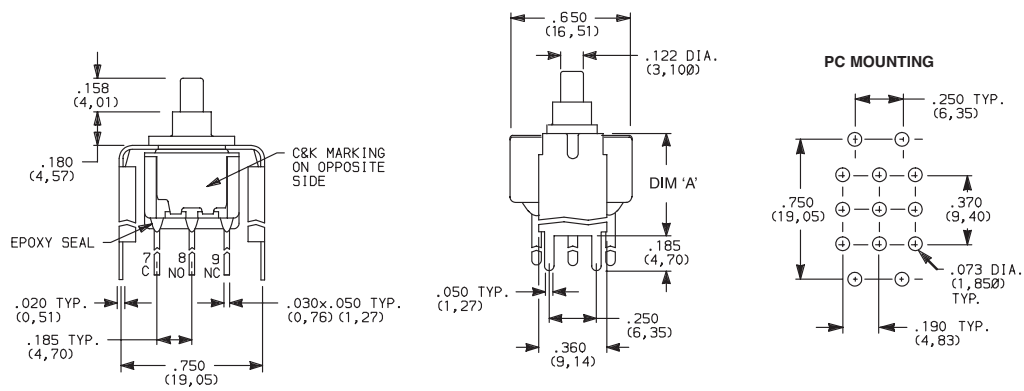

8321SD3_GE 3PDT

| OPTION CODE | DIM 'A' |
|-------------|--------------|
| V2 | .555 (14,10) |
| V7 | .630 (16,00) |
| V8 | .953 (24,21) |

Not available with JXX actuators and I seal.

V2, V7, V8 VERTICAL MOUNT, V-BRACKET

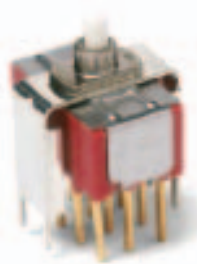
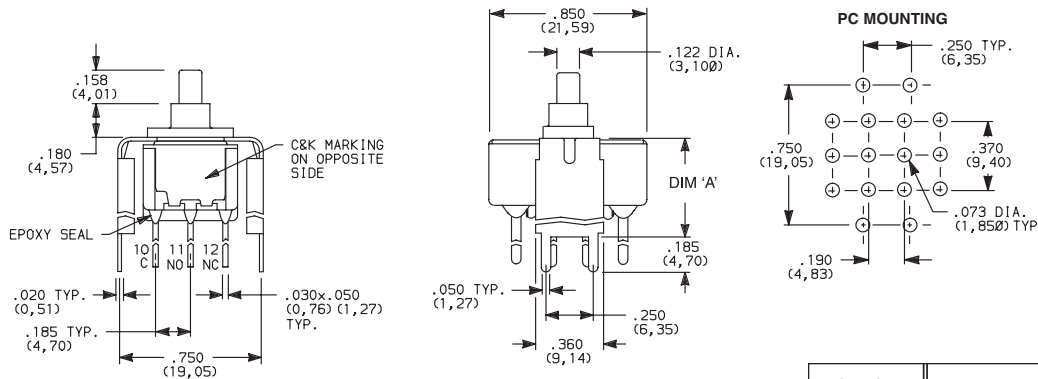

8421SD3_GE 4PDT

| OPTION CODE | DIM 'A' |
|-------------|--------------|
| V2 | .555 (14,10) |
| V7 | .630 (16,00) |
| V8 | .953 (24,21) |

Not available with JXX actuators and I seal.

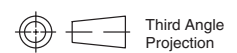

Dimensions are shown: Inches (mm)
Specifications and dimensions subject to change

www.ck-components.com



8020 Series Snap-acting Momentary Pushbutton Switches

TERMINATIONS



V3, V4, V9 VERTICAL MOUNT, V-BRACKET

V31 VERTICAL MOUNT, V-BRACKET, SNAP-IN



8121SD3_GE
SPDT

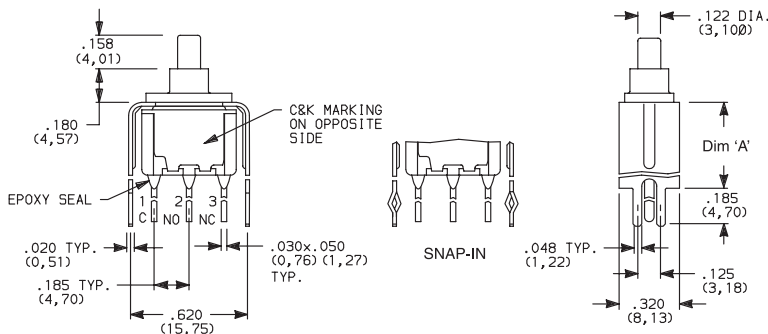

PC MOUNTING

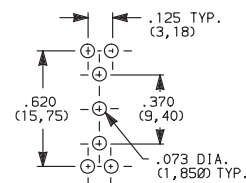

| OPTION CODE | DIM 'A' |
|----------------|---------------|
| V3, V31 | .460 (11,68) |
| V4 | .630 (16,00) |
| V9 | 1.150 (29,21) |

Not available with J8X actuators and I seal.

V3, V4, V9 VERTICAL MOUNT, V-BRACKET

V31 VERTICAL MOUNT, V-BRACKET, SNAP-IN



8221SD3_GE
DPDT

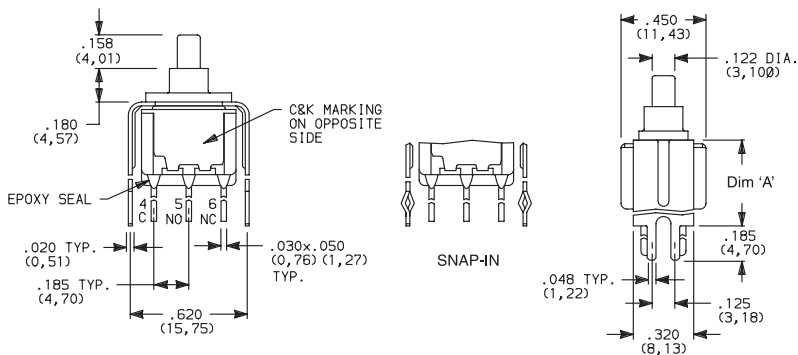

PC MOUNTING

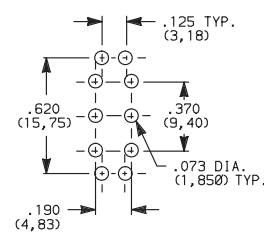

| OPTION CODE | DIM 'A' |
|----------------|---------------|
| V3, V31 | .460 (11,68) |
| V4 | .630 (16,00) |
| V9 | 1.150 (29,21) |

Not available with J8X actuators and I seal.

V4, V9 VERTICAL MOUNT, V-BRACKET



8321SD3V4GE
3PDT

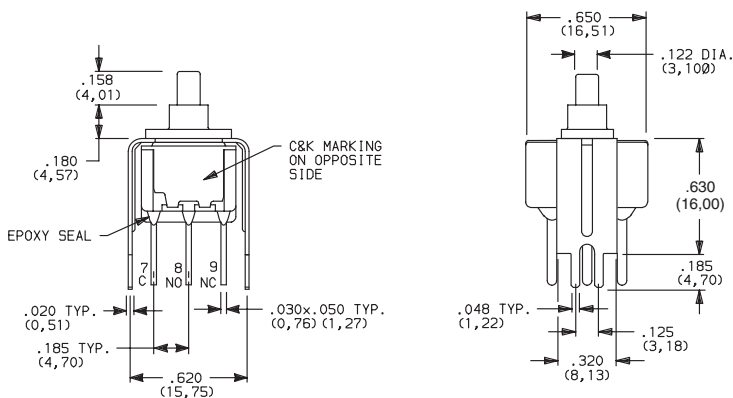

PC MOUNTING

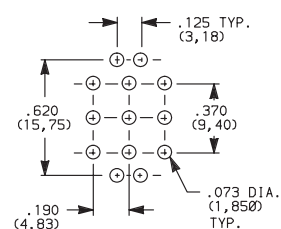

| OPTION CODE | DIM 'A' |
|-------------|---------------|
| V4 | .630 (16,00) |
| V9 | 1.150 (29,21) |

Not available with JXX actuators and I seal.

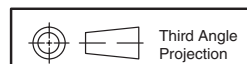

Third Angle
Projection



Dimensions are shown: Inches (mm)
Specifications and dimensions subject to change

www.ck-components.com

8020 Series Snap-acting Momentary Pushbutton Switches



A

Pushbutton

TERMINATIONS

V4, V9 VERTICAL MOUNT, V-BRACKET

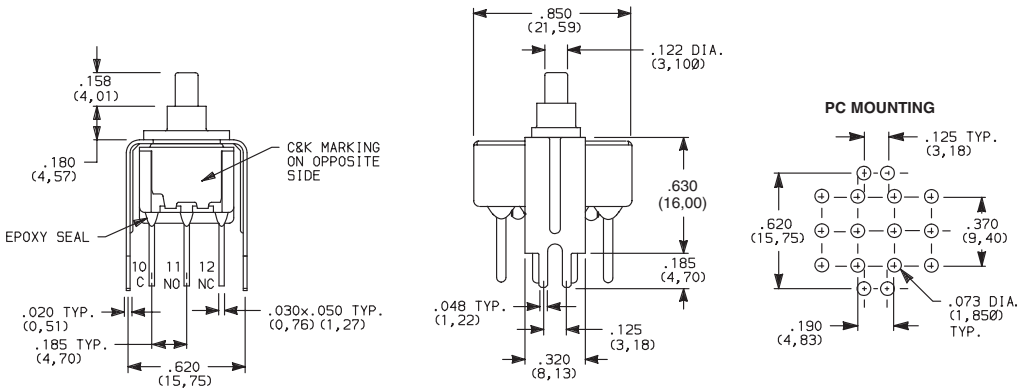

8421SD3V4GE
4PDT

| OPTION CODE | DIM 'A' |
|-------------|---------------|
| V4 | .630 (16,00) |
| V9 | 1.150 (29,21) |

Not available with JXX actuators and I seal.

CONTACT MATERIAL

| OPTION CODE | CONTACT MATERIAL | TERMINAL PLATING | RATINGS | |
|-------------|----------------------|------------------|--------------------------------|---|
| B | GOLD 1 | GOLD 1 | LOW LEVEL/DRY CIRCUIT | 8x25 MODELS ONLY: 0.4 MAX. @ 20 V AC OR DC MAX. |
| P | | MATTE-TIN 4 | | |
| G | GOLD OVER SILVER 2,3 | GOLD 3 | LOW LEVEL/DRY CIRCUIT OR POWER | 8X21, U8X1 MODELS ONLY: 0.4 VA MAX @ 20 V AC OR DC MAX. OR 1 AMP @ 120 V AC OR 28 V DC. |
| R | | MATTE-TIN 4 | | |

* Note: See Technical Data section of this catalog for RoHS compliant and compatible definitions and specifications.

- 1 ALL CONTACTS & TERMINALS: Copper alloy, with gold plate over nickel plate.
- 2 N.O. AND N.C. CONTACTS: Coin silver, with gold plate over nickel plate.
- 3 COMMON CONTACTS & ALL TERMINALS: Copper alloy, with gold plate over nickel plate.
- 4 TERMINALS: Copper alloy, with matte-tin over nickel plate.

NOTE: Any models supplied with B, P, R or G contact material are RoHS compliant.
U811-U841 models with all options (except R, R2 terminations) when ordered with mandatory G or R contact material.
B or P contact material must be ordered with 8X25 models.
G or R contact material must be ordered with 8X21, U8X1 models.
P or R contact material not available with Z, Z3 terminations.

SEAL

E EPOXY SEAL

I EPOXY POTTED BASE

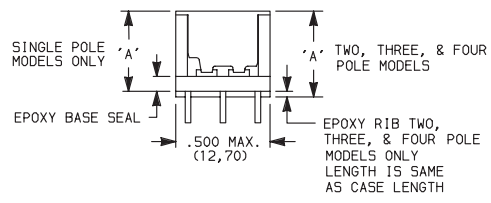
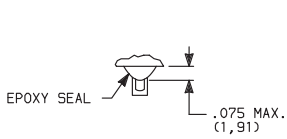

| NO. POLES | DIM 'A' |
|-----------|--------------|
| SP | .410 (10,41) |
| DP | .440 (11,18) |
| 3P | .505 (12,83) |
| 4P | .505 (12,83) |

NOTE: Available with C, W-W4, Z, Z3 terminations only.

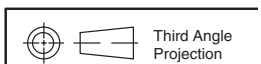

Dimensions are shown: Inches (mm)
Specifications and dimensions subject to change



www.ck-components.com



8020 Series Snap-acting Momentary Pushbutton Switches

Pushbutton

A

AVAILABLE HARDWARE

Cap

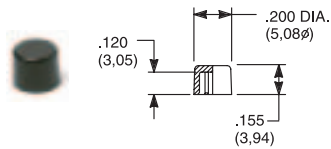

PART NO.

708901000 WHITE
708902000 BLACK
708903000 RED
708904000 ORANGE
708905000 YELLOW
708906000 GREEN
708907000 BLUE
708909000 GRAY

Material: Nylon
Finish: Gloss

Cap

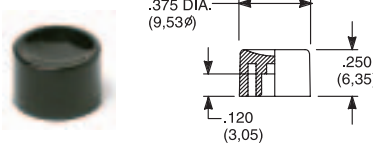

PART NO.

752701000 WHITE
752702000 BLACK
752703000 RED
752704000 ORANGE
752705000 YELLOW
752706000 GREEN
752707000 BLUE
752709000 GRAY

Material: Nylon
Finish: Gloss

Cap

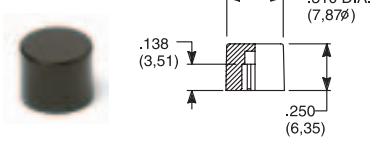

PART NO.

801801000 WHITE
801802000 BLACK
801803000 RED
801804000 ORANGE
801805000 YELLOW
801806000 GREEN
801807000 BLUE
801809000 GRAY

Material: Nylon
Finish: Gloss

Cap, Snap-fitting plunger

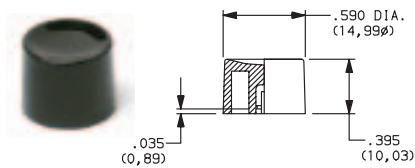

PART NO.

894001000 WHITE
894002000 BLACK
894003000 RED
894004000 ORANGE
894005000 YELLOW
894006000 GREEN
894007000 BLUE
894009000 GRAY

Material: Nylon
Finish: Gloss

Cap, Snap-fitting plunger

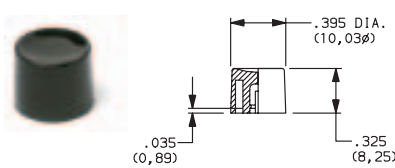

PART NO.

894101000 WHITE
894102000 BLACK
894103000 RED
894104000 ORANGE
894105000 YELLOW
894106000 GREEN
894107000 BLUE
894109000 GRAY

Material: Nylon
Finish: Gloss

Cap, J80, J81, J82, J83 & J84 options only

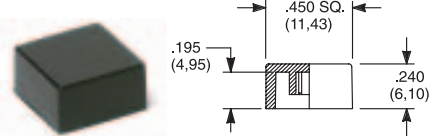

PART NO.

484601000 WHITE
484602000 BLACK
484603000 RED
484604000 ORANGE
484605000 YELLOW
484606000 GREEN
484607000 BLUE
484609000 GRAY

Material: Nylon
Finish: Gloss

PART NO.

798201000 WHITE
798202263 BLACK
798203000 RED
798204000 ORANGE
798205000 YELLOW
798206000 GREEN
798207000 BLUE
798209000 GRAY

Material: Nylon
Finish: Matte

Frame



PART NO.

615601000 WHITE
615602263 BLACK
615603000 RED
615605000 YELLOW
615606000 GREEN
615609000 GRAY

Material: Nylon
Finish: Matte

Frame



PART NO.

613301000 WHITE
613302263 BLACK
613303000 RED
613305000 YELLOW
613306000 GREEN
613309000 GRAY

Material: Nylon
Finish: Matte

Cap, J85 & J95 options only

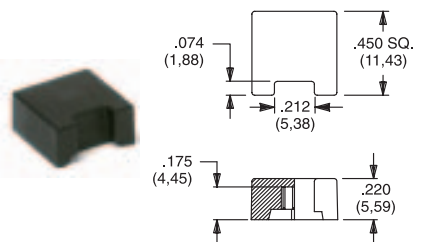

PART NO.

459701000 WHITE
459702000 BLACK
459703000 RED
459704000 ORANGE
459705000 YELLOW
459706000 GREEN
459707000 BLUE
459709000 GRAY

Material: Nylon
Finish: Gloss

PART NO.

476801000 WHITE
476802000 BLACK
476803000 RED
476804000 ORANGE
476805000 YELLOW
476806000 GREEN
476807000 BLUE
476809000 GRAY

Material: Nylon
Finish: Matte

Fits Z3 Termination female connector



PART NO.

530100000

Available in loose pieces.

NOTE: Additional nuts, locking rings and lockwashers available separately, see section "Technical Data and Additional Hardware".

Other cap & frame colors available, consult Customer Service Center.



Third Angle
Projection

Dimensions are shown: Inches (mm)
Specifications and dimensions subject to change

C&K

www.ck-components.com

8020 Series Snap-acting Momentary Pushbutton Switches



A

Pushbutton

AVAILABLE HARDWARE

Frames snap into panel opening and are independent from switch mounting. Accurate positioning of the PC mounted switch relative to the panel opening is necessary to provide proper clearance between actuator and frame. Available in two basic styles and four panel thicknesses .047-.125 in. Material: Nylon. Finish: Matte.

TYPICAL APPLICATION

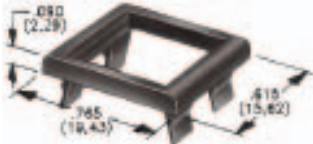
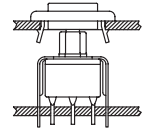

.047" (1,19) PANEL THK. .062" (1,57) PANEL THK. .090" (2,29) PANEL THK. .125" (3,18) PANEL THK.

| PART NO. | PART NO. | PART NO. | PART NO. | |
|-----------|-----------|-----------|-----------|--------|
| 432501000 | 432601000 | 432701000 | 432801000 | WHITE |
| 432502263 | 432602263 | 432702263 | 432802263 | BLACK |
| 432503000 | 432603000 | 432703000 | 432803000 | RED |
| 432505000 | 432605000 | 432705000 | 432805000 | YELLOW |
| 432506000 | 432606000 | 432706000 | 432806000 | GREEN |
| 432509000 | 432609000 | 432709000 | 432809000 | GRAY |

PANEL MOUNTING

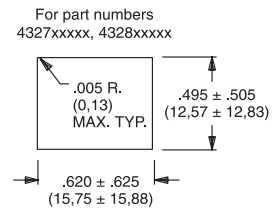
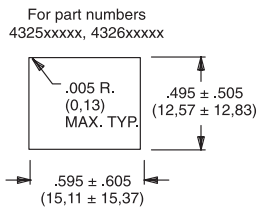

Panel Inserts

Above frames (part nos. 432XXXXXX) are also available with insert which accepts LED for indicator light assembly. Order insert separately from frame. Blank insert panel (without hole for LED) also available. **LED not included.**

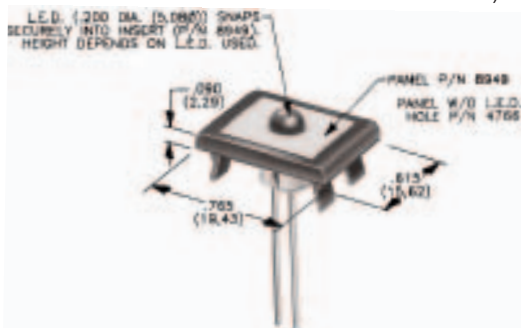

PANEL INSERT WITH HOLE FOR LED

| PART NO. |
|-----------|
| 894901000 |
| 894902000 |
| 894903000 |
| 894905000 |
| 894906000 |
| 894909000 |

BLANK PANEL INSERT WITHOUT HOLE FOR LED

| PART NO. | |
|-----------|--------|
| 476601000 | WHITE |
| 476602000 | BLACK |
| 476603000 | RED |
| 476605000 | YELLOW |
| 476606000 | GREEN |
| 476609000 | GRAY |

Special colors, custom markings available, consult Customer Service Center.

LED INFORMATION

SWITCHES WITH LED SUPPLIED: J85, J95 OPTIONS:

Rectangular LEDs are supplied on 8020 Series pushbutton switches with J85 and J95 options. These LEDs are factory installed and are not replaceable. The following specifications apply:

| OPTION CODE | COLOR | TYP. INTENSITY | TYP. FORWARD VOLTAGE | TYP. FORWARD CURRENT | MAX RATINGS AT 25°C AMBIENT TEMPERATURE | | |
|-------------|--------|----------------|----------------------|----------------------|---|----------------------------|-------------------|
| | | | | | FORWARD VOLTAGE | CONTINUOUS FORWARD CURRENT | POWER DISSIPATION |
| 6 | Green | 1.0 mcd | 2.1 V | 20 mA | 2.5 V | 50 mA | 125 mW |
| 3 | Red* | 0.5 mcd | | 10 mA | | 30 mA | 75 mW |
| 5 | Yellow | 4.0 mcd | | 20 mA | | 50 mA | 125 mW |

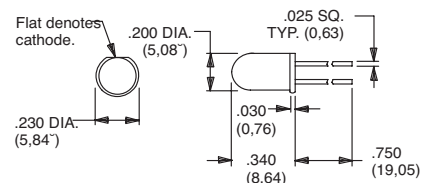

Suggested LED for J82 & J84 options. Dimensions for reference only.

Process Information: Soldering to LED leads must be completed within 5 seconds at 500°F (260°C) maximum.

Caution: Circuit elements must limit forward current of LED to 50mA max. continuous.

* Extra-bright red LED available (typ. intensity 4.5 mcd), consult Customer Service Center. LEDs are not supplied with J82, J84 options. LED snaps into switch frame surrounding actuator and is wired externally.

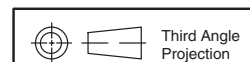

Dimensions are shown: Inches (mm)
Specifications and dimensions subject to change



www.ck-components.com