

MC74HC08A

Quad 2-Input AND Gate High-Performance Silicon-Gate CMOS

The MC74HC08A is identical in pinout to the LS08. The device inputs are compatible with Standard CMOS outputs; with pullup resistors, they are compatible with LSTTL outputs.

Features

- Output Drive Capability: 10 LSTTL Loads
- Outputs Directly Interface to CMOS, NMOS and TTL
- Operating Voltage Range: 2.0 to 6.0 V
- Low Input Current: 1 μ A
- High Noise Immunity Characteristic of CMOS Devices
- In Compliance With the JEDEC Standard No. 7A Requirements
- Chip Complexity: 24 FETs or 6 Equivalent Gates
- Pb-Free Packages are Available

LOGIC DIAGRAM

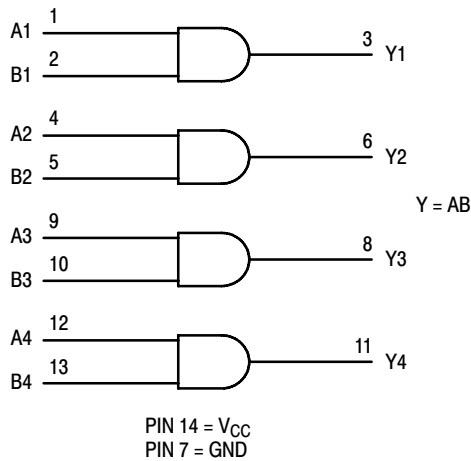

Pinout: 14-Lead Packages (Top View)

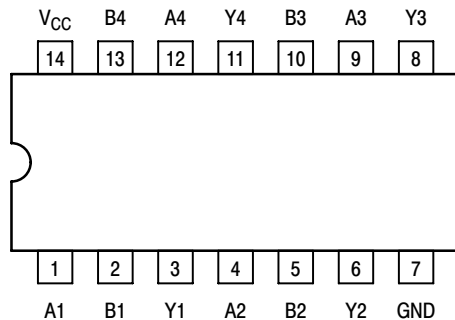

ON Semiconductor®

MARKING DIAGRAMS

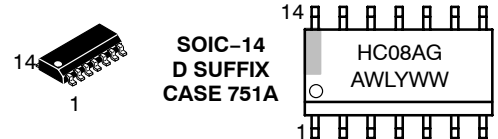
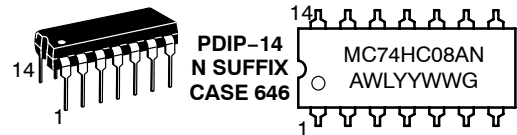

A = Assembly Location
WL or L = Wafer Lot
YY or Y = Year
WW or W = Work Week
G or ■ = Pb-Free Package

(Note: Microdot may be in either location)

FUNCTION TABLE

| Inputs | | Output |
|--------|---|--------|
| A | B | Y |
| L | L | L |
| L | H | L |
| H | L | L |
| H | H | H |

ORDERING INFORMATION

See detailed ordering and shipping information in the package dimensions section on page 3 of this data sheet.

MC74HC08A

MAXIMUM RATINGS

| Symbol | Parameter | Value | Unit |
|-----------|---|-------------------------|------|
| V_{CC} | DC Supply Voltage (Referenced to GND) | - 0.5 to + 7.0 | V |
| V_{in} | DC Input Voltage (Referenced to GND) | - 0.5 to $V_{CC} + 0.5$ | V |
| V_{out} | DC Output Voltage (Referenced to GND) | - 0.5 to $V_{CC} + 0.5$ | V |
| I_{in} | DC Input Current, per Pin | ± 20 | mA |
| I_{out} | DC Output Current, per Pin | ± 25 | mA |
| I_{CC} | DC Supply Current, V_{CC} and GND Pins | ± 50 | mA |
| P_D | Power Dissipation in Still Air, Plastic DIP† SOIC Package† TSSOP Package† | 750 500 450 | mW |
| T_{stg} | Storage Temperature | - 65 to + 150 | °C |
| T_L | Lead Temperature, 1 mm from Case for 10 Seconds Plastic DIP, SOIC or TSSOP Package | 260 | °C |

This device contains protection circuitry to guard against damage due to high static voltages or electric fields. However, precautions must be taken to avoid applications of any voltage higher than maximum rated voltages to this high-impedance circuit. For proper operation, V_{in} and V_{out} should be constrained to the range $GND \leq (V_{in} \text{ or } V_{out}) \leq V_{CC}$. Unused inputs must always be tied to an appropriate logic voltage level (e.g., either GND or V_{CC}). Unused outputs must be left open.

Stresses exceeding Maximum Ratings may damage the device. Maximum Ratings are stress ratings only. Functional operation above the Recommended Operating Conditions is not implied. Extended exposure to stresses above the Recommended Operating Conditions may affect device reliability.

†Derating — Plastic DIP: - 10 mW/°C from 65° to 125°C
SOIC Package: - 7 mW/°C from 65° to 125°C
TSSOP Package: - 6.1 mW/°C from 65° to 125°C

For high frequency or heavy load considerations, see Chapter 2 of the ON Semiconductor High-Speed CMOS Data Book (DL129/D).

RECOMMENDED OPERATING CONDITIONS

| Symbol | Parameter | Min | Max | Unit |
|-------------------|--|------|----------|------|
| V_{CC} | DC Supply Voltage (Referenced to GND) | 2.0 | 6.0 | V |
| V_{in}, V_{out} | DC Input Voltage, Output Voltage (Referenced to GND) | 0 | V_{CC} | V |
| T_A | Operating Temperature, All Package Types | - 55 | + 125 | °C |
| t_r, t_f | Input Rise and Fall Time (Figure 1) | | | ns |
| | $V_{CC} = 2.0 \text{ V}$ | 0 | 1000 | |
| | $V_{CC} = 4.5 \text{ V}$ | 0 | 500 | |
| | $V_{CC} = 6.0 \text{ V}$ | 0 | 400 | |

MC74HC08A

ORDERING INFORMATION

| Device | Package | Shipping† |
|----------------|------------------------|------------------|
| MC74HC08AN | PDIP-14 | 25 Units / Rail |
| MC74HC08ANG | PDIP-14 (Pb-Free) | |
| MC74HC08AD | SOIC-14 | 55 Units / Rail |
| MC74HC08ADG | SOIC-14 (Pb-Free) | |
| MC74HC08ADR2 | SOIC-14 | 2500/Tape & Reel |
| MC74HC08ADR2G | SOIC-14 (Pb-Free) | |
| MC74HC08ADTR2 | TSSOP-14* | |
| MC74HC08ADTR2G | TSSOP-14* | |
| MC74HC08AFEL | SOEIAJ-14 | 2000/Tape & Reel |
| MC74HC08AFELG | SOEIAJ-14 (Pb-Free) | |

†For information on tape and reel specifications, including part orientation and tape sizes, please refer to our Tape and Reel Packaging Specifications Brochure, BRD8011/D.

*This package is inherently Pb-Free.

MC74HC08A

DC CHARACTERISTICS (Voltages Referenced to GND)

| Symbol | Parameter | Condition | V _{CC} V | Guaranteed Limit | | | Unit |
|-----------------|--|---|----------------------|------------------|-------|--------|------|
| | | | | -55 to 25°C | ≤85°C | ≤125°C | |
| V _{IH} | Minimum High-Level Input Voltage | V _{out} = 0.1V or V _{CC} - 0.1V I _{out} ≤ 20μA | 2.0 | 1.50 | 1.50 | 1.50 | V |
| | | | 3.0 | 2.10 | 2.10 | 2.10 | |
| | | | 4.5 | 3.15 | 3.15 | 3.15 | |
| | | | 6.0 | 4.20 | 4.20 | 4.20 | |
| V _{IL} | Maximum Low-Level Input Voltage | V _{out} = 0.1V or V _{CC} - 0.1V I _{out} ≤ 20μA | 2.0 | 0.50 | 0.50 | 0.50 | V |
| | | | 3.0 | 0.90 | 0.90 | 0.90 | |
| | | | 4.5 | 1.35 | 1.35 | 1.35 | |
| | | | 6.0 | 1.80 | 1.80 | 1.80 | |
| V _{OH} | Minimum High-Level Output Voltage | V _{in} = V _{IH} or V _{IL} I _{out} ≤ 20μA | 2.0 | 1.9 | 1.9 | 1.9 | V |
| | | | 4.5 | 4.4 | 4.4 | 4.4 | |
| | | | 6.0 | 5.9 | 5.9 | 5.9 | |
| | | V _{in} = V _{IH} or V _{IL} I _{out} ≤ 2.4mA I _{out} ≤ 4.0mA I _{out} ≤ 5.2mA | 3.0 | 2.48 | 2.34 | 2.20 | |
| | | | 4.5 | 3.98 | 3.84 | 3.70 | |
| | | | 6.0 | 5.48 | 5.34 | 5.20 | |
| V _{OL} | Maximum Low-Level Output Voltage | V _{in} = V _{IH} or V _{IL} I _{out} ≤ 20μA | 2.0 | 0.1 | 0.1 | 0.1 | V |
| | | | 4.5 | 0.1 | 0.1 | 0.1 | |
| | | | 6.0 | 0.1 | 0.1 | 0.1 | |
| | | V _{in} = V _{IH} or V _{IL} I _{out} ≤ 2.4mA I _{out} ≤ 4.0mA I _{out} ≤ 5.2mA | 3.0 | 0.26 | 0.33 | 0.40 | |
| | | | 4.5 | 0.26 | 0.33 | 0.40 | |
| | | | 6.0 | 0.26 | 0.33 | 0.40 | |
| I _{in} | Maximum Input Leakage Current | V _{in} = V _{CC} or GND | 6.0 | ±0.1 | ±1.0 | ±1.0 | μA |
| I _{CC} | Maximum Quiescent Supply Current (per Package) | V _{in} = V _{CC} or GND I _{out} = 0μA | 6.0 | 1.0 | 10 | 40 | μA |

NOTE: Information on typical parametric values can be found in Chapter 2 of the ON Semiconductor High-Speed CMOS Data Book (DL129/D).

AC CHARACTERISTICS (C_L = 50pF, Input t_r = t_f = 6ns)

| Symbol | Parameter | V _{CC} V | Guaranteed Limit | | | Unit |
|--|--|----------------------|------------------|-------|--------|------|
| | | | -55 to 25°C | ≤85°C | ≤125°C | |
| t _{PLH} , t _{PHL} | Maximum Propagation Delay, Input A or B to Output Y (Figures 1 and 2) | 2.0 | 75 | 95 | 110 | ns |
| | | 3.0 | 30 | 40 | 55 | |
| | | 4.5 | 15 | 19 | 22 | |
| | | 6.0 | 13 | 16 | 19 | |
| t _{TLH} , t _{THL} | Maximum Output Transition Time, Any Output (Figures 1 and 2) | 2.0 | 75 | 95 | 110 | ns |
| | | 3.0 | 27 | 32 | 36 | |
| | | 4.5 | 15 | 19 | 22 | |
| | | 6.0 | 13 | 16 | 19 | |
| C _{in} | Maximum Input Capacitance | | 10 | 10 | 10 | pF |

NOTE: For propagation delays with loads other than 50 pF, and information on typical parametric values, see Chapter 2 of the ON Semiconductor High-Speed CMOS Data Book (DL129/D).

| C _{PD} | Power Dissipation Capacitance (Per Buffer)* | Typical @ 25°C, V _{CC} = 5.0 V, V _{EE} = 0 V | | pF |
|-----------------|---|--|--|----|
| | | 20 | | |
| | | | | |

* Used to determine the no-load dynamic power consumption: P_D = C_{PD} V_{CC}²f + I_{CC} V_{CC}. For load considerations, see Chapter 2 of the ON Semiconductor High-Speed CMOS Data Book (DL129/D).

MC74HC08A

PACKAGE DIMENSIONS

PDIP-14
CASE 646-06
ISSUE P

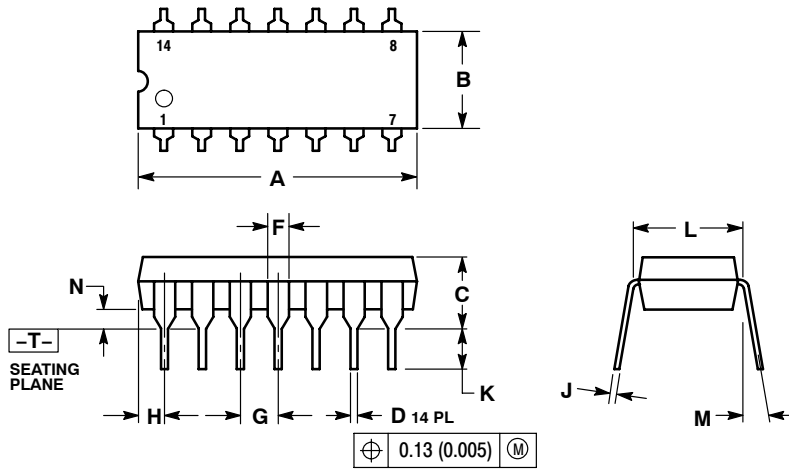

NOTES:

1. DIMENSIONING AND TOLERANCING PER ANSI Y14.5M, 1982.
2. CONTROLLING DIMENSION: INCH.
3. DIMENSION L TO CENTER OF LEADS WHEN FORMED PARALLEL.
4. DIMENSION B DOES NOT INCLUDE MOLD FLASH.
5. ROUNDED CORNERS OPTIONAL.

| DIM | INCHES | | MILLIMETERS | |
|-----|-----------|-------|-------------|-------|
| | MIN | MAX | MIN | MAX |
| A | 0.715 | 0.770 | 18.16 | 19.56 |
| B | 0.240 | 0.260 | 6.10 | 6.60 |
| C | 0.145 | 0.185 | 3.69 | 4.69 |
| D | 0.015 | 0.021 | 0.38 | 0.53 |
| F | 0.040 | 0.070 | 1.02 | 1.78 |
| G | 0.100 BSC | | 2.54 BSC | |
| H | 0.052 | 0.095 | 1.32 | 2.41 |
| J | 0.008 | 0.015 | 0.20 | 0.38 |
| K | 0.115 | 0.135 | 2.92 | 3.43 |
| L | 0.290 | 0.310 | 7.37 | 7.87 |
| M | --- | 10° | --- | 10° |
| N | 0.015 | 0.039 | 0.38 | 1.01 |

MC74HC08A

PACKAGE DIMENSIONS

SOIC-14
CASE 751A-03
ISSUE H

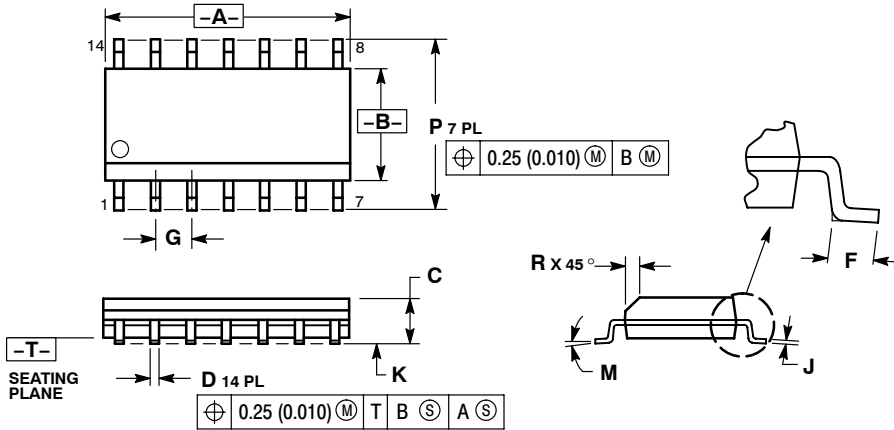

NOTES:

1. DIMENSIONING AND TOLERANCING PER ANSI Y14.5M, 1982.
2. CONTROLLING DIMENSION: MILLIMETER.
3. DIMENSIONS A AND B DO NOT INCLUDE MOLD PROTRUSION.
4. MAXIMUM MOLD PROTRUSION 0.15 (0.006) PER SIDE.
5. DIMENSION D DOES NOT INCLUDE DAMBAR PROTRUSION. ALLOWABLE DAMBAR PROTRUSION SHALL BE 0.127 (0.005) TOTAL IN EXCESS OF THE D DIMENSION AT MAXIMUM MATERIAL CONDITION.

| DIM | MILLIMETERS | | INCHES | |
|-----|-------------|------|-----------|-------|
| | MIN | MAX | MIN | MAX |
| A | 8.55 | 8.75 | 0.337 | 0.344 |
| B | 3.80 | 4.00 | 0.150 | 0.157 |
| C | 1.35 | 1.75 | 0.054 | 0.068 |
| D | 0.35 | 0.49 | 0.014 | 0.019 |
| F | 0.40 | 1.25 | 0.016 | 0.049 |
| G | 1.27 BSC | | 0.050 BSC | |
| J | 0.19 | 0.25 | 0.008 | 0.009 |
| K | 0.10 | 0.25 | 0.004 | 0.009 |
| M | 0° | 7° | 0° | 7° |
| P | 5.80 | 6.20 | 0.228 | 0.244 |
| R | 0.25 | 0.50 | 0.010 | 0.019 |

SOLDERING FOOTPRINT*

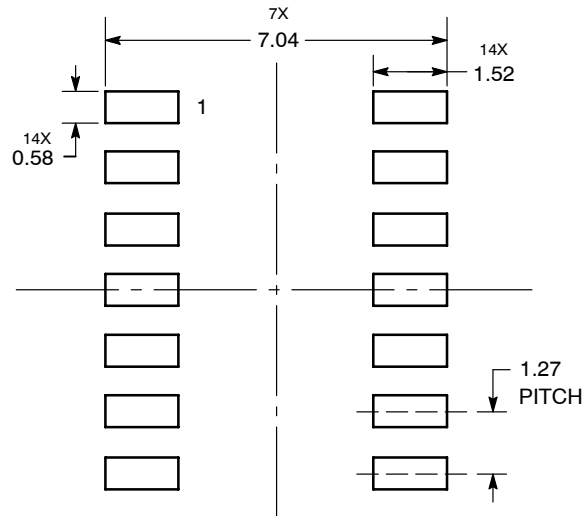

DIMENSIONS: MILLIMETERS

*For additional information on our Pb-Free strategy and soldering details, please download the ON Semiconductor Soldering and Mounting Techniques Reference Manual, SOLDERRM/D.