

# PRODUCT DATA SHEET

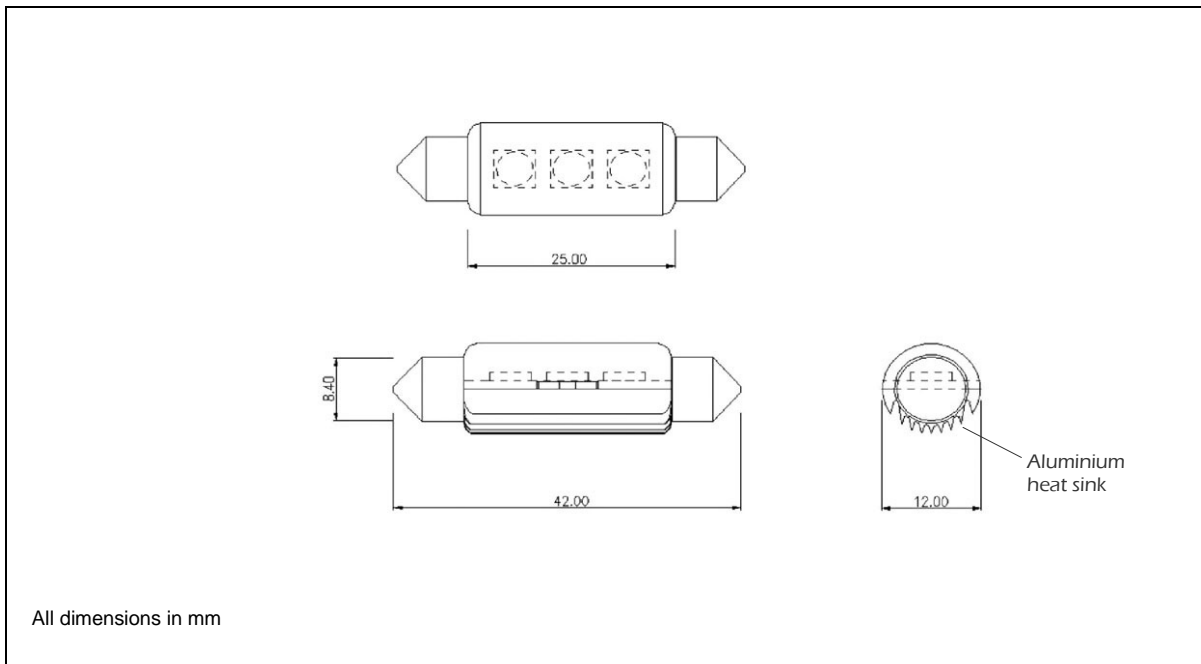

T-3<sup>3</sup>/<sub>4</sub> (T12 x 42MM LED FESTOON LAMP – 1W

FESLED24010WW



Design Voltage:	VDC VAC	24
Current Consumption:	mA	40
Power Consumption	mW	1000
Light Output:	Lm	52 ± 8
Viewing Angle:	Degrees	120°
Colour Appearance:	Warm White	
COLOUR Rendering Index	80	
Colour Temperature:	°K	2850 – 3200
LED Type:	SMD x 3	
Operating Temperature:	°C	-20 / +60
Storage Temperature:	°C	-25 / +80
Life Duration (@24V)	Hours	20,000



## Notes:

- 1) SV8.5-8 base to IEC61-1, data sheet 7004-81-x.
- 2) LED type: PLCC-6, InGaN + phosphor.
- 3) Operating Voltage: 24~28VAC / DC (bi-polarity).
- 4) Life Duration figure represents time to 50% reduction in light output compared with initial value.
- 5) Lamp body incorporates a finned aluminium heat sink.
- 6) Marking: ~ Aluminium heat sink marked "24V AC/DC"
- 7) Unit weight: 5.0g
- 8) RoHS compliant.

Clandell Ltd  
[www.clandell.com](http://www.clandell.com)