

Photoelectric sensor



**E3F2***Threaded Cylindrical Photoelectric Sensors with Built-in Amplifier for Use as an Optical Proximity Switch***Features**

- M18 DIN-sized cylindrical housing
- Housing materials: plastic, nickel plated brass and stainless steel
- Axial and radial types (with integrated 90°-optics)
- Enclosure rating IP67
- DC switching types with connectors for easy maintenance
- Full metal plug-in type
- Sensing distance separate types : 7 m, 10 m
- Retroreflective polarizing types: 2 m, 4 m
- Background suppression type: 10 cm
- Long detection distance (0.3 m, 1 m) with sensitivity adjuster for diffuse type
- Wide-beam characteristics (10 cm) for diffuse type
- Wide operating voltage range (10 to 30 VDC or 24 to 240 VAC)
- Short-circuit and reverse connection protection (DC switching type)
- UL and CSA approved (AC switching types)
- UL listed (DC switching types)

## Selection Guide

### DC-Switching Models

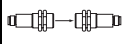
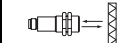
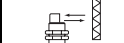
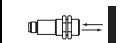
Housing Material: Plastic

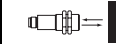
Sensing method		Appearance	Connection method	Sensing distance	Model		
					PNP output	NPN output	
<b>Through-beam</b>	Multi purpose	 axial	pre-wired	7 m	E3F2-7B4	E3F2-7C4	
			M12 connector		E3F2-7B4-P1	E3F2-7C4-P1	
	- precision detection <sup>(*)</sup> - test input		pre-wired	10 m	E3F2-10B4	E3F2-10C4	
			M12 connector		E3F2-10B4-P1	E3F2-10C4-P1	
<b>Retro-reflective</b> (incl. reflector E39-R1 or E39-R1S)	Non-polarizing (without MSR function)	 axial	pre-wired	0.1 - 2 m <sup>(2)</sup>	E3F2-R2B4	E3F2-R2C4	
			M12 connector		E3F2-R2B4-P1	E3F2-R2C4-P1	
	Polarizing (with MSR function)		Fixed sensitivity	pre-wired	0.1 - 4 m <sup>(3)</sup>	E3F2-R4B4F	E3F2-R4C4F
				M12 connector		E3F2-R4B4F-P1	E3F2-R4C4F-P1
	Adjustable sensitivity		pre-wired	E3F2-R4B4		E3F2-R4C4	
			M12 connector	E3F2-R4B4-P1		E3F2-R4C4-P1	
	Non-polarizing (without MSR function)		 radial	pre-wired	0.1 - 2 m <sup>(2)</sup>	-	-
				M12 connector		-	-
	Polarizing (with MSR function)			pre-wired	E3F2-R2RB41	E3F2-R2RC41	
				M12 connector	E3F2-R2RB41-P1	E3F2-R2RC41-P1	
<b>Diffuse reflective</b>	Fixed sensitivity Wide-beam characteristics	 axial	pre-wired	0.1 m	E3F2-DS10B4-N	E3F2-DS10C4-N	
			M12 connector		E3F2-DS10B4-P1	E3F2-DS10C4-P1	
	Adjustable sensitivity		pre-wired	0.3 m	E3F2-DS30B4	E3F2-DS30C4	
			M12 connector		E3F2-DS30B4-P1	E3F2-DS30C4-P1	
			pre-wired	1 m	E3F2-D1B4	E3F2-D1C4	
			M12 connector		E3F2-D1B4-P1	E3F2-D1C4-P1	
	Fixed sensitivity Wide-beam characteristics		 radial	pre-wired	0.1 m	-	-
				M12 connector		-	-
Adjustable sensitivity	pre-wired	0.3 m		E3F2-DS30B41	E3F2-DS30C41		
	M12 connector			E3F2-DS30B41-P1	E3F2-DS30C41-P1		
<b>Background suppression</b>	Fixed sensing distance	 axial	pre-wired	10 cm	E3F2-LS10B4	E3F2-LS10C4	
			M12 connector		E3F2-LS10B4-P1	E3F2-LS10C4-P1	







<sup>(\*)</sup> with slit E39-ES18

<sup>(2)</sup> with reflector E39-R1

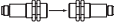
<sup>(3)</sup> with reflector E39-R1S

Note: Standard cable length is 2 m. Models provided with a 5 m long cable are available. When ordering, specify the cable length by adding the length of the cable (e.g. E3F2-R2RB4 2M or E3F2-R2RB4 5M). For other cable length please contact your OMRON sales representative.

Housing material: Metal (Nickel plated brass)





Sensing method		Appearance	Connection method	Sensing distance	Model		
					PNP output	NPN output	
<b>Through-beam</b>	Multi purpose		 axial	pre-wired	7 m	E3F2-7B4-M	E3F2-7C4-M
				M12 connector		E3F2-7B4-M1-M	E3F2-7C4-M1-M
	- precision detection - test input			pre-wired	10 m	E3F2-10B4-M	E3F2-10C4-M
						M12 connector	E3F2-10B4-M1-M
<b>Retro-reflective</b> (incl. reflector E39-R1)	Non-polarizing (without MSR function)		 axial	pre-wired	0.1 - 2 m <sup>(*)</sup>	-	-
				M12 connector		-	-
	Polarizing (with MSR function)	Fixed sensitivity		pre-wired		E3F2-R2RB4-M	E3F2-R2RC4-M
				M12 connector		E3F2-R2RB4-M1-M	E3F2-R2RC4-M1-M
		Adjustable sensitivity		pre-wired		E3F2-R4B4F-M	E3F2-R4C4F-M
				M12 connector		E3F2-R4B4F-M1-M	E3F2-R4C4F-M1-M
			pre-wired	E3F2-R4B4-M	E3F2-R4C4-M		
			M12 connector	E3F2-R4B4-M1-M	E3F2-R4C4-M1-M		
	Non-polarizing (without MSR function)		 radial	pre-wired	0.1 - 2 m <sup>(*)</sup>	-	-
				M12 connector		-	-
	Polarizing (with MSR function)			pre-wired		E3F2-R2RB41-M	E3F2-R2RC41-M
				M12 connector		E3F2-R2RB41-M1-M	E3F2-R2RC41-M1-M
<b>Diffuse reflective</b>	Fixed sensing distance Wide-beam characteristics		 axial	pre-wired	0.1 m	E3F2-DS10B4-M	E3F2-DS10C4-M
				M12 connector		E3F2-DS10B4-M1-M	E3F2-DS10C4-M1-M
	Adjustable sensing distance			pre-wired		E3F2-DS30B4-M	E3F2-DS30C4-M
				M12 connector		E3F2-DS30B4-M1-M	E3F2-DS30C4-M1-M
			pre-wired	1 m	E3F2-D1B4-M	E3F2-D1C4-M	
			M12 connector	E3F2-D1B4-M1-M	E3F2-D1C4-M1-M		
	Fixed sensing distance Wide-beam characteristics		 radial	pre-wired	0.1 m	-	-
				M12 connector		-	-
Adjustable sensing distance		pre-wired		E3F2-DS30B41-M		E3F2-DS30C41-M	
		M12 connector		E3F2-DS30B41-M1-M		E3F2-DS30C41-M1-M	
<b>Background suppression</b>	Fixed sensing distance		 axial	pre-wired	10 cm	E3F2-LS10B4-M	E3F2-LS10C4-M
				M12 connector		E3F2-LS10B4-M1-M	E3F2-LS10C4-M1-M

<sup>(\*)</sup> with reflector E39-R1

<sup>(\*)</sup> with reflector E39-R1S

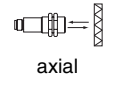
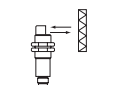
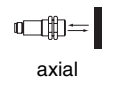
Note: Standard cable length is 2 m. Models provided with a 5 m long cable are available. When ordering, specify the cable length by adding the length of the cable (e.g. E3F2-R2RB4-M 2M or E3F2-R2RB4-M 5M). For other cable length please contact your OMRON sales representative.

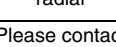
Housing material: Metal (Stainless steel)

Sensing method		Appearance	Connection	Sensing	Model	
			method	distance	PNP output	NPN output
<b>Through-beam</b>		 axial	pre-wired	7 m	<b>E3F2-7B4-S</b>	<b>E3F2-7C4-S</b>
			M12 connector		<b>E3F2-7B4-M1-S</b>	<b>E3F2-7C4-M1-S</b>
<b>Retro-reflective</b> (incl. reflector E39-R1)	Non-polarizing (without MSR function)	 axial	pre-wired	0.1 - 2 m (with reflector E39-R1)	-	-
			M12 connector		-	-
	Polarizing (with MSR function)	pre-wired	<b>E3F2-R2RB4-S</b>		<b>E3F2-R2RC4-S</b>	
		M12 connector	<b>E3F2-R2RB4-M1-S</b>		<b>E3F2-R2RC4-M1-S</b>	
	Non-polarizing (without MSR function)	 radial	pre-wired		-	-
			M12 connector		-	-
	Polarizing (with MSR function)	pre-wired	-	-		
		M12 connector	-	-		
<b>Diffuse reflective</b>	Fixed sensitivity Wide-beam characteristics	 axial	pre-wired	0.1 m	<b>E3F2-DS10B4-S</b>	<b>E3F2-DS10C4-S</b>
			M12 connector		<b>E3F2-DS10B4-M1-S</b>	<b>E3F2-DS10C4-M1-S</b>
	Adjustable sensitivity	 radial	pre-wired	0.3 m	<b>E3F2-DS30B4-S</b>	<b>E3F2-DS30C4-S</b>
			M12 connector		<b>E3F2-DS30B4-M1-S</b>	<b>E3F2-DS30C4-M1-S</b>
	Fixed sensitivity Wide-beam characteristics	 radial	pre-wired	0.1 m	-	-
			M12 connector		-	-
	Adjustable sensitivity	 radial	pre-wired	0.3 m	-	-
			M12 connector		-	-
<b>Background suppression</b>		Please contact your OMRON sales representative for these models				

Note: Standard cable length is 2 m. Models provided with a 5 m long cable are available. When ordering, specify the cable length by adding the length of the cable (e.g. E3F2-R2RB4-S 2M or E3F2-R2RB4-S 5M). For other cable length please contact your OMRON sales representative.

### AC-Switching Models

Housing material: Plastic

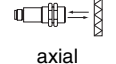
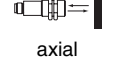
Sensing method		Appearance	Connection	Sensing	Model	
			method	distance	Light-ON	Dark-ON
<b>Through-beam</b>		 axial	pre-wired	3 m	<b>E3F2-3Z1</b>	<b>E3F2-3Z2</b>
<b>Retro-reflective</b> (incl. reflector E39-R1)	Non-polarizing (without MSR function)	 axial	pre-wired	0.1 - 2 m (with reflector E39-R1)	<b>E3F2-R2Z1</b>	<b>E3F2-R2Z2</b>
<b>Diffuse reflective</b>	Fixed sensing distance Wide-beam characteristics	 axial	pre-wired	0.1 m	<b>E3F2-DS10Z1-N</b>	<b>E3F2-DS10Z2-N</b>

Note: Standard cable length is 2 m. Models provided with a 5 m long cable are available. When ordering, specify the cable length by adding the length of the cable (e.g. E3F2-R2Z1 2M or E3F2-R2Z1 5M). For other cable length please contact your OMRON sales representative.





Accessories (Order Separately)

Name	Sensing distance (typical) [1.]	Model	Remark
Reflectors	0.1 - 3.7 m (axial) 0.1 - 2.4 m (radial)	<b>E39-R1</b>	60 x 40 mm (included in some models)
	0.1 - 4.3 m (axial)	<b>E39-R1S</b>	for E3F2-R4
	0.1 - 4.2 m (axial) 0.1 - 2.7 m (radial)	<b>E39-R7</b>	84 mm
	0.1 - 5.3 m (axial) 0.1 - 3.1 m (radial)	<b>E39-R8</b>	100 x 100 mm
	0.1 - 4.3 m (axial)	<b>E39-R40</b>	80 x 80 mm
Tape Reflectors		<b>E39-RSA</b>	35 x 10 mm
		<b>E39-RSB</b>	35 x 40 mm
		<b>E39-RS3</b>	80 x 70 mm
Lens Cap		<b>E39-F31</b>	
Mounting Bracket		<b>Y92E-B18</b>	screw mount
		<b>Y92E-G18</b>	quick access mounting
Slit		<b>E39-ES18</b>	for E3F2-10□ - precision detection

For detailed information about Accessories, refer to the main chapter "Accessories" at the end of the document.

Note: 1. Typical sensing distance corresponds to 80 % of the max. sensing distance. For details, please refer to "Engineering Data".

Sensor I/O Connectors

Cord	Shape	Cable type		Model
Standard	Straight 	2 m	Four-wire type	<b>XS2F-D421-D80-A</b>
		5 m		<b>XS2F-D421-G80-A</b>
	L-shaped 	2 m		<b>XS2F-D422-D80-A</b>
		5 m		<b>XS2F-D422-G80-A</b>
Vibration-proof robot cable	Straight 	2 m		<b>XS2F-D421-D80-R</b>
		5 m		<b>XS2F-D421-G80-R</b>
	L-shaped 	2 m		<b>XS2F-D422-D80-R</b>
		5 m		<b>XS2F-D422-G80-R</b>

Ordering Information: type list

DC-Switching Models, plastic

Model	Sensing method, sensing distance	Appearance	Connection (cable-length)	Control output	Comments
E3F2-7B4 2M	Through-beam, 7 m	axial	Pre-wired (2 m)*	PNP	Receiver and Emitter
E3F2-7B4-P1	Through-beam, 7 m	axial	Connector	PNP	Receiver and Emitter
E3F2-7C4 2M	Through-beam, 7 m	axial	Pre-wired (2 m)*	NPN	Receiver and Emitter
E3F2-7C4-P1	Through-beam, 7 m	axial	Connector	NPN	Receiver and Emitter
E3F2-7DB4 2M	Through-beam, 7 m	axial	Pre-wired (2 m)*	PNP	Receiver only
E3F2-7DB4-P1	Through-beam, 7 m	axial	Connector	PNP	Receiver only
E3F2-7DC4 2M	Through-beam, 7 m	axial	Pre-wired (2 m)*	NPN	Receiver only
E3F2-7DC4-P1	Through-beam, 7 m	axial	Connector	NPN	Receiver only
E3F2-7L 2M	Through-beam, 7 m	axial	Pre-wired (2 m)*	N.A.	Emitter only
E3F2-7L -P1	Through-beam, 7 m	axial	Connector	N.A.	Emitter only
E3F2-10B4 2M	Through-beam, 10m	axial	Pre-wired (2m)*	PNP	Receiver and Emitter (precision detection and test input)
E3F2-10B4-P1	Through-beam, 10m	axial	Connector	PNP	Receiver and Emitter (precision detection and test input)
E3F2-10DB4 2M	Through-beam, 10m	axial	Pre-wired (2m)*	PNP	Receiver only (precision detection and test input)
E3F2-10DB4-P1	Through-beam, 10m	axial	Connector	PNP	Receiver only (precision detection and test input)
E3F2-10C4 2M	Through-beam, 10m	axial	Pre-wired (2m)*	NPN	Receiver and Emitter (precision detection and test input)
E3F2-10C4-P1	Through-beam, 10m	axial	Connector	NPN	Receiver and Emitter (precision detection and test input)
E3F2-10DC4 2M	Through-beam, 10m	axial	Pre-wired (2m)*	NPN	Receiver only (precision detection and test input)
E3F2-10DC4-P1	Through-beam, 10m	axial	Connector	NPN	Receiver only (precision detection and test input)
E3F2-10LB 2M	Through-beam, 10m	axial	Pre-wired (2m)*	PNP	Emitter only (precision detection and test input)
E3F2-10LB-P1	Through-beam, 10m	axial	Connector	PNP	Emitter only (precision detection and test input)
E3F2-DS10B4-N 2M	Diffuse reflective, 0.1 m	axial	Pre-wired (2 m)*	PNP	Wide-beam characteristic
E3F2-DS10B4-P1	Diffuse reflective, 0.1 m	axial	Connector	PNP	Wide-beam characteristic
E3F2-DS10C4-N 2M	Diffuse reflective, 0.1 m	axial	Pre-wired (2 m)*	NPN	Wide-beam characteristic
E3F2-DS10C4-P1	Diffuse reflective, 0.1 m	axial	Connector	NPN	Wide-beam characteristic
E3F2-DS30B4 2M	Diffuse reflective, 0.3 m	axial	Pre-wired (2 m)*	PNP	Sensitivity adjuster
E3F2-DS30B41 2M	Diffuse reflective, 0.3 m	radial	Pre-wired (2 m)*	PNP	Sensitivity adjuster
E3F2-DS30B41-P1	Diffuse reflective, 0.3 m	radial	Connector	PNP	Sensitivity adjuster
E3F2-DS30B4-P1	Diffuse reflective, 0.3 m	axial	Connector	PNP	Sensitivity adjuster
E3F2-DS30C4 2M	Diffuse reflective, 0.3 m	axial	Pre-wired (2 m)*	NPN	Sensitivity adjuster
E3F2-DS30C41 2M	Diffuse reflective, 0.3 m	radial	Pre-wired (2 m)*	NPN	Sensitivity adjuster
E3F2-DS30C41-P1	Diffuse reflective, 0.3 m	radial	Connector	NPN	Sensitivity adjuster
E3F2-DS30C4-P1	Diffuse reflective, 0.3 m	axial	Connector	NPN	Sensitivity adjuster
E3F2-D1B4 2M	Diffuse reflective, 1 m	axial	Pre-wired (2 m)*	PNP	Sensitivity adjuster
E3F2-D1B4-P1	Diffuse reflective, 1 m	axial	Connector	PNP	Sensitivity adjuster
E3F2-D1C4 2M	Diffuse reflective, 1 m	axial	Pre-wired (2 m)*	NPN	Sensitivity adjuster
E3F2-D1C4-P1	Diffuse reflective, 1 m	axial	Connector	NPN	Sensitivity adjuster
E3F2-LS10B4 2M	Background suppression, 10 cm	axial	Pre-wired (2 m)*	PNP	Background suppression
E3F2-LS10B4-P1	Background suppression, 10 cm	axial	Connector	PNP	Background suppression
E3F2-LS10C4 2M	Background suppression, 10 cm	axial	Pre-wired (2 m)*	NPN	Background suppression
E3F2-LS10C4-P1	Background suppression, 10 cm	axial	Connector	NPN	Background suppression
E3F2-R2B4 2M	Retroreflective, 2 m	axial	Pre-wired (2 m)*	PNP	Non-polarizing
E3F2-R2B4-E 2M	Retroreflective, 2 m	axial	Pre-wired (2 m)*	PNP	Non-polarizing, without reflector
E3F2-R2B4-P1	Retroreflective, 2 m	axial	Connector	PNP	Non-polarizing
E3F2-R2B4-P1-E	Retroreflective, 2 m	axial	Connector	PNP	Non-polarizing, without reflector
E3F2-R2C4 2M	Retroreflective, 2 m	axial	Pre-wired (2 m)*	NPN	Non-polarizing
E3F2-R2C4-E 2M	Retroreflective, 2 m	axial	Pre-wired (2 m)*	NPN	Non-polarizing, without reflector
E3F2-R2C4-P1	Retroreflective, 2 m	axial	Connector	NPN	Non-polarizing

Model	Sensing method, sensing distance	Appearance	Connection (cable-length)	Control output	Comments
E3F2-R2C4-P1-E	Retroreflective, 2 m	axial	Connector	NPN	Non-polarizing, without reflector
E3F2-R2RB41 2M	Retroreflective, 2 m	radial	Pre-wired (2 m)*	PNP	Polarizing
E3F2-R2RB41-E 2M	Retroreflective, 2 m	radial	Pre-wired (2 m)*	PNP	Polarizing, without reflector
E3F2-R2RB41-P1	Retroreflective, 2 m	radial	Connector	PNP	Polarizing
E3F2-R2RB41-P1-E	Retroreflective, 2 m	radial	Connector	PNP	Polarizing, without reflector
E3F2-R2RC41 2M	Retroreflective, 2 m	radial	Pre-wired (2 m)*	NPN	Polarizing
E3F2-R2RC41-E 2M	Retroreflective, 2 m	radial	Pre-wired (2 m)*	NPN	Polarizing, without reflector
E3F2-R2RC41-P1	Retroreflective, 2 m	radial	Connector	NPN	Polarizing
E3F2-R2RC41-P1-E	Retroreflective, 2 m	radial	Connector	NPN	Polarizing, without reflector
E3F2-R4B4 2M	Retroreflective, 4m	axial	Pre-wired (2m)*	PNP	Polarizing, sensitivity adjuster
E3F2-R4B4-E 2M	Retroreflective, 4m	axial	Pre-wired (2m)*	PNP	Polarizing, sensitivity adjuster, w/o reflector
E3F2-R4B4F 2M	Retroreflective, 4m	axial	Pre-wired (2m)*	PNP	Polarizing, fixed sensitivity
E3F2-R4B4F-E 2M	Retroreflective, 4m	axial	Pre-wired (2m)*	PNP	Polarizing, fixed sensitivity w/o reflector
E3F2-R4C4 2M	Retroreflective, 4m	axial	Pre-wired (2m)*	NPN	Polarizing, sensitivity adjuster
E3F2-R4C4-E 2M	Retroreflective, 4m	axial	Pre-wired (2m)*	NPN	Polarizing, sensitivity adjuster, w/o reflector
E3F2-R4C4F 2M	Retroreflective, 4m	axial	Pre-wired (2m)*	NPN	Polarizing, fixed sensitivity
E3F2-R4C4F-E 2M	Retroreflective, 4m	axial	Pre-wired (2m)*	NPN	Polarizing, fixed sensitivity w/o reflector
E3F2-R4B4-P1	Retroreflective, 4m	axial	Connector	PNP	Polarizing, sensitivity adjuster
E3F2-R4B4-P1-E	Retroreflective, 4m	axial	Connector	PNP	Polarizing, sensitivity adjuster, w/o reflector
E3F2-R4B4F-P1	Retroreflective, 4m	axial	Connector	PNP	Polarizing, fixed sensitivity
E3F2-R4B4F-P1-E	Retroreflective, 4m	axial	Connector	PNP	Polarizing, fixed sensitivity w/o reflector
E3F2-R4C4-P1	Retroreflective, 4m	axial	Connector	NPN	Polarizing, sensitivity adjuster
E3F2-R4C4-P1-E	Retroreflective, 4m	axial	Connector	NPN	Polarizing, sensitivity adjuster, w/o reflector
E3F2-R4C4F-P1	Retroreflective, 4m	axial	Connector	NPN	Polarizing, fixed sensitivity
E3F2-R4C4F-P1-E	Retroreflective, 4m	axial	Connector	NPN	Polarizing, fixed sensitivity w/o reflector

\* Standard cable length is 2 m. Models provided with a 5 m long cable are available. When ordering, specify the cable length by adding the length of the cable (e.g. E3F2-R2RB41 2M or E3F2-R2RB41 5M). For other cable length please contact your OMRON sales representative.

DC-Switching Models, metal (nickel plated brass)

Model	Sensing method, sensing range	Appearance	Connection (cable-length)	Control output	Comments
E3F2-7B4-M 2M	Through-beam, 7 m	axial	Pre-wired (2 m)*	PNP	Receiver and Emitter
E3F2-7B4-M1-M	Through-beam, 7 m	axial	Connector	PNP	Receiver and Emitter
E3F2-7C4-M 2M	Through-beam, 7 m	axial	Pre-wired (2 m)*	NPN	Receiver and Emitter
E3F2-7C4-M1-M	Through-beam, 7 m	axial	Connector	NPN	Receiver and Emitter
E3F2-7DB4-M 2M	Through-beam, 7 m	axial	Pre-wired (2 m)*	PNP	Receiver only
E3F2-7DB4-M1-M	Through-beam, 7 m	axial	Connector	PNP	Receiver only
E3F2-7DC4-M 2M	Through-beam, 7 m	axial	Pre-wired (2 m)*	NPN	Receiver only
E3F2-7DC4-M1-M	Through-beam, 7 m	axial	Connector	NPN	Receiver only
E3F2-7L-M 2M	Through-beam, 7 m	axial	Pre-wired (2 m)*	N.A	Emitter only
E3F2-7L-M1-M	Through-beam, 7 m	axial	Connector	N.A	Emitter only
E3F2-10B4-M 2M	Through-beam, 10m	axial	Pre-wired (2m)*	PNP	Receiver and Emitter (precision detection and test input)
E3F2-10B4-M1-M	Through-beam, 10m	axial	Connector	PNP	Receiver and Emitter (precision detection and test input)
E3F2-10DB4-M 2M	Through-beam, 10m	axial	Pre-wired (2m)*	PNP	Receiver only (precision detection and test input)
E3F2-10DB4-M1-M	Through-beam, 10m	axial	Connector	PNP	Receiver only (precision detection and test input)
E3F2-10C4-M 2M	Through-beam, 10m	axial	Pre-wired (2m)*	NPN	Receiver and Emitter (precision detection and test input)
E3F2-10C4-M1-M	Through-beam, 10m	axial	Connector	NPN	Receiver and Emitter (precision detection and test input)
E3F2-10DC4-M 2M	Through-beam, 10m	axial	Pre-wired (2m)*	NPN	Receiver only (precision detection and test input)
E3F2-10DC4-M1-M	Through-beam, 10m	axial	Connector	NPN	Receiver only (precision detection and test input)
E3F2-10LB-M 2M	Through-beam, 10m	axial	Pre-wired (2m)*	PNP	Emitter only (precision detection and test input)

Model	Sensing method, sensing range	Appearance	Connection (cable-length)	Control output	Comments
E3F2-10LB-M 2M	Through-beam, 10m	axial	Pre-wired (2m)*	PNP	Emitter only (precision detection and test input)
E3F2-10LB-M1-M	Through-beam, 10m	axial	Connector	PNP	Emitter only (precision detection and test input)
E3F2-DS10B4-M 2M	Diffuse reflective, 0.1 m	axial	Pre-wired (2 m)*	PNP	Wide-beam characteristic
E3F2-DS10B4-M1-M	Diffuse reflective, 0.1 m	axial	Connector	PNP	Wide-beam characteristic
E3F2-DS10C4-M 2M	Diffuse reflective, 0.1 m	axial	Pre-wired (2 m)*	NPN	Wide-beam characteristic
E3F2-DS10C4-M1-M	Diffuse reflective, 0.1 m	axial	Connector	NPN	Wide-beam characteristic
E3F2-DS30B41-M 2M	Diffuse reflective, 0.3 m	radial	Pre-wired (2 m)*	PNP	Sensitivity adjuster
E3F2-DS30B41-M1-M	Diffuse reflective, 0.3 m	radial	Connector	PNP	Sensitivity adjuster
E3F2-DS30B4-M 2M	Diffuse reflective, 0.3 m	axial	Pre-wired (2 m)*	PNP	Sensitivity adjuster
E3F2-DS30B4-M1-M	Diffuse reflective, 0.3 m	axial	Connector	PNP	Sensitivity adjuster
E3F2-DS30C41-M 2M	Diffuse reflective, 0.3 m	radial	Pre-wired (2 m)*	NPN	Sensitivity adjuster
E3F2-DS30C41-M1-M	Diffuse reflective, 0.3 m	radial	Connector	NPN	Sensitivity adjuster
E3F2-DS30C4-M 2M	Diffuse reflective, 0.3 m	axial	Pre-wired (2 m)*	NPN	Sensitivity adjuster
E3F2-DS30C4-M1-M	Diffuse reflective, 0.3 m	axial	Connector	NPN	Sensitivity adjuster
E3F2-D1B4-M 2M	Diffuse reflective, 1 m	axial	Pre-wired (2m)*	PNP	Sensitivity adjuster
E3F2-D1B4-M1-M	Diffuse reflective, 1 m	axial	Connector	PNP	Sensitivity adjuster
E3F2-D1C4-M 2M	Diffuse reflective, 1 m	axial	Pre-wired (2m)*	NPN	Sensitivity adjuster
E3F2-D1C4-M1-M	Diffuse reflective, 1 m	axial	Connector	NPN	Sensitivity adjuster
E3F2-LS10B4-M 2M	Background suppression, 10 cm	axial	Pre-wired (2m)*	PNP	Background suppression
E3F2-LS10B4-M1-M	Background suppression, 10 cm	axial	Connector	PNP	Background suppression
E3F2-LS10C4-M 2M	Background suppression, 10 cm	axial	Pre-wired (2m)*	NPN	Background suppression
E3F2-LS10C4-M1-M	Background suppression, 10 cm	axial	Connector	NPN	Background suppression
E3F2-R2RB41-M 2M	Retroreflective, 2 m	radial	Pre-wired (2 m)*	PNP	Polarizing
E3F2-R2RB41-M1-M	Retroreflective, 2 m	radial	Connector	PNP	Polarizing
E3F2-R2RB41-M1-M-E	Retroreflective, 2 m	radial	Connector	PNP	Polarizing, without reflector
E3F2-R2RB41-M-E 2M	Retroreflective, 2 m	radial	Pre-wired (2 m)*	PNP	Polarizing, without reflector
E3F2-R2RB4-M 2M	Retroreflective, 2 m	axial	Pre-wired (2 m)*	PNP	Polarizing
E3F2-R2RB4-M1-M	Retroreflective, 2 m	axial	Connector	PNP	Polarizing
E3F2-R2RB4-M1-M-E	Retroreflective, 2 m	axial	Connector	PNP	Polarizing, without reflector
E3F2-R2RB4-M-E 2M	Retroreflective, 2 m	axial	Pre-wired (2 m)*	PNP	Polarizing, without reflector
E3F2-R2RC41-M 2M	Retroreflective, 2 m	radial	Pre-wired (2 m)*	NPN	Polarizing
E3F2-R2RC41-M1-M	Retroreflective, 2 m	radial	Connector	NPN	Polarizing
E3F2-R2RC41-M1-M-E	Retroreflective, 2 m	radial	Connector	NPN	Polarizing, without reflector
E3F2-R2RC41-M-E 2M	Retroreflective, 2 m	radial	Pre-wired (2 m)*	NPN	Polarizing, without reflector
E3F2-R2RC4-M 2M	Retroreflective, 2 m	axial	Pre-wired (2 m)*	NPN	Polarizing
E3F2-R2RC4-M1-M	Retroreflective, 2 m	axial	Connector	NPN	Polarizing
E3F2-R2RC4-M1-M-E	Retroreflective, 2 m	axial	Connector	NPN	Polarizing, without reflector
E3F2-R2RC4-M-E 2M	Retroreflective, 2 m	axial	Pre-wired (2 m)*	NPN	Polarizing, without reflector
E3F2-R4B4-M 2M	Retroreflective, 4m	axial	Pre-wired (2m)*	PNP	Polarizing, sensitivity adjuster
E3F2-R4B4-M-E 2M	Retroreflective, 4m	axial	Pre-wired (2m)*	PNP	Polarizing, sensitivity adjuster, w/o reflector
E3F2-R4B4F-M 2M	Retroreflective, 4m	axial	Pre-wired (2m)*	PNP	Polarizing, fixed sensitivity
E3F2-R4B4F-M-E 2M	Retroreflective, 4m	axial	Pre-wired (2m)*	PNP	Polarizing, fixed sensitivity w/o reflector
E3F2-R4C4-M 2M	Retroreflective, 4m	axial	Pre-wired (2m)*	NPN	Polarizing, sensitivity adjuster
E3F2-R4C4-M-E 2M	Retroreflective, 4m	axial	Pre-wired (2m)*	NPN	Polarizing, sensitivity adjuster, w/o reflector
E3F2-R4C4F-M 2M	Retroreflective, 4m	axial	Pre-wired (2m)*	NPN	Polarizing, fixed sensitivity
E3F2-R4C4F-M-E 2M	Retroreflective, 4m	axial	Pre-wired (2m)*	NPN	Polarizing, fixed sensitivity w/o reflector
E3F2-R4B4-M1-M	Retroreflective, 4m	axial	Connector	PNP	Polarizing, sensitivity adjuster
E3F2-R4B4-M1-M-E	Retroreflective, 4m	axial	Connector	PNP	Polarizing, sensitivity adjuster, w/o reflector
E3F2-R4B4F-M1-M	Retroreflective, 4m	axial	Connector	PNP	Polarizing, fixed sensitivity
E3F2-R4B4F-M1-M-E	Retroreflective, 4m	axial	Connector	PNP	Polarizing, fixed sensitivity w/o reflector
E3F2-R4C4-M1-M	Retroreflective, 4m	axial	Connector	NPN	Polarizing, sensitivity adjuster
E3F2-R4C4-M1-M-E	Retroreflective, 4m	axial	Connector	NPN	Polarizing, sensitivity adjuster, w/o reflector
E3F2-R4C4F-M1-M	Retroreflective, 4m	axial	Connector	NPN	Polarizing, fixed sensitivity



Model	Sensing method, sensing range	Appearance	Connection (cable-length)	Control output	Comments
E3F2-R4C4F-M1-M-E	Retroreflective, 4m	axial	Connector	NPN	Polarizing, fixed sensitivity w/o reflector

\* Standard cable length is 2 m. Models provided with a 5 m long cable are available. When ordering, specify the cable length by adding the length of the cable (e.g. E3F2-R2RB41-M 2M or E3F2-R2RB41-M 5M). For other cable length please contact your OMRON sales representative.

DC-Switching Models, metal (stainless steel)

Model	Sensing method, sensing range	Appearance	Connection (cable-length)	Control output	Comments
E3F2-7B4-M1-S	Through-beam, 7 m	axial	Connector	PNP	Receiver and Emitter
E3F2-7B4-S 2M	Through-beam, 7 m	axial	Pre-wired (2 m)*	PNP	Receiver and Emitter
E3F2-7C4-M1-S	Through-beam, 7 m	axial	Connector	NPN	Receiver and Emitter
E3F2-7C4-S 2M	Through-beam, 7 m	axial	Pre-wired (2 m)*	NPN	Receiver and Emitter
E3F2-7DB4-M1-S	Through-beam, 7 m	axial	Connector	PNP	Receiver only
E3F2-7DB4-S 2M	Through-beam, 7 m	axial	Pre-wired (2 m)*	PNP	Receiver only
E3F2-7DC4-M1-S	Through-beam, 7 m	axial	Connector	NPN	Receiver only
E3F2-7DC4-S 2M	Through-beam, 7 m	axial	Pre-wired (2 m)*	NPN	Receiver only
E3F2-7L-M1-S	Through-beam, 7 m	axial	Connector	N.A.	Emitter only
E3F2-7L-S 2M	Through-beam, 7 m	axial	Pre-wired (2 m)*	N.A.	Emitter only
E3F2-DS10B4-M1-S	Diffuse reflective, 0.1 m	axial	Connector	PNP	Wide-beam characteristic
E3F2-DS10B4-S 2M	Diffuse reflective, 0.1 m	axial	Pre-wired (2 m)*	PNP	Wide-beam characteristic
E3F2-DS10C4-M1-S	Diffuse reflective, 0.1 m	axial	Connector	NPN	Wide-beam characteristic
E3F2-DS10C4-S 2M	Diffuse reflective, 0.1 m	axial	Pre-wired (2 m)*	NPN	Wide-beam characteristic
E3F2-DS30B4-M1-S	Diffuse reflective, 0.3 m	axial	Connector	PNP	Sensitivity adjuster
E3F2-DS30B4-S 2M	Diffuse reflective, 0.3 m	axial	Pre-wired (2 m)*	PNP	Sensitivity adjuster
E3F2-DS30C4-M1-S	Diffuse reflective, 0.3 m	axial	Connector	NPN	Sensitivity adjuster
E3F2-DS30C4-S 2M	Diffuse reflective, 0.3 m	axial	Pre-wired (2 m)*	NPN	Sensitivity adjuster
E3F2-R2RB4-M1-S	Retroreflective, 2 m	axial	Connector	PNP	Polarizing
E3F2-R2RB4-M1-S-E	Retroreflective, 2 m	axial	Connector	PNP	Polarizing, without reflector
E3F2-R2RB4-S 2M	Retroreflective, 2 m	axial	Pre-wired (2 m)*	PNP	Polarizing
E3F2-R2RB4-S-E 2M	Retroreflective, 2 m	axial	Pre-wired (2 m)*	PNP	Polarizing, without reflector
E3F2-R2RC4-M1-S	Retroreflective, 2 m	axial	Connector	NPN	Polarizing
E3F2-R2RC4-M1-S-E	Retroreflective, 2 m	axial	Connector	NPN	Polarizing, without reflector
E3F2-R2RC4-S 2M	Retroreflective, 2 m	axial	Pre-wired (2 m)*	NPN	Polarizing
E3F2-R2RC4-S-E 2M	Retroreflective, 2 m	axial	Pre-wired (2 m)*	NPN	Polarizing, without reflector

\* Standard cable length is 2 m. Models provided with a 5 m long cable are available. When ordering, specify the cable length by adding the length of the cable (e.g. E3F2-R2RB41-S 2M or E3F2-R2RB41-S 5M). For other cable length please contact your OMRON sales representative.

AC-Switching Models, plastic

Model	Sensing method, sensing range	Appearance	Connection (cable-length)	Control output	Comments
E3F2-3LZ 2M	Through-beam, 3 m	axial	Pre-wired (2 m)*	N.A.	Emitter only
E3F2-3DZ1 2M	Through-beam, 3 m	axial	Pre-wired (2 m)*	Light-ON	Receiver only
E3F2-3DZ2 2M	Through-beam, 3 m	axial	Pre-wired (2 m)*	Dark-ON	Receiver only
E3F2-3Z1 2M	Through-beam, 3 m	axial	Pre-wired (2 m)*	Light-ON	Receiver and Emitter
E3F2-3Z2 2M	Through-beam, 3 m	axial	Pre-wired (2 m)*	Dark-ON	Receiver and Emitter
E3F2-R2Z1 2M	Retroreflective, 2 m	axial	Pre-wired (2 m)*	Light-ON	Non-polarizing
E3F2-R2Z2 2M	Retroreflective, 2 m	axial	Pre-wired (2 m)*	Dark-ON	Non-polarizing
E3F2-R2Z1-E 2M	Retroreflective, 2 m	axial	Pre-wired (2 m)*	Light-ON	Non-polarizing, without reflector
E3F2-R2Z2-E 2M	Retroreflective, 2 m	axial	Pre-wired (2 m)*	Dark-ON	Non-polarizing, without reflector
E3F2-DS10Z1-N 2M	Diffuse reflective, 0.1 m	axial	Pre-wired (2 m)*	Light-ON	Wide-beam characteristic
E3F2-DS10Z2-N 2M	Diffuse reflective, 0.1 m	axial	Pre-wired (2 m)*	Dark-ON	Wide-beam characteristic

\* Standard cable length is 2 m. Models provided with a 5 m long cable are available. When ordering, specify the cable length by adding the length of the cable (e.g. E3F2-R2Z1 2M or E3F2-R2Z1 5M). For other cable length please contact your OMRON sales representative.

# Specifications

## Ratings / Characteristics of DC Switching Models

Item	E3F2-7□	E3F2-10□	E3F2-R2□4□	E3F2-R2R□	E3F2-R4□□	E3F2-DS10□	E3F2-DS30□	E3F2-D1□4□	E3F2-LS10□4□
Sensing method	Through-beam		Retroreflective			Diffuse reflective			
	- multi purpose	- Precision detection [7.] - test input	Non-polarizing	Polarizing		Wide beam characteristic	Adjustable sensing distance		Background suppression
Power supply voltage	10 to 30 V DC		12 to 24 V DC			10 to 30 V DC			
Current consumption	50 mA max.		25 mA max.	30 mA max.		25 mA max.	30 mA max.		
Rated sensing distance [1.]	7 m	10 m	0.1 - 2 m (with reflector E39-R1)		0.1 - 4 m (with reflector E39-R1S)	0.1 m (5 x 5 cm white mat paper)	0.3 m (10 x 10 cm white mat paper)	1 m (30 x 30 cm white mat paper)	0.1 m (10 x 10 cm white mat paper)
Typical sensing distance for different reflector types (ref. to accessories) [2.]	-		E39-R1: 4.0 m E39-R7: 4.5 m E39-R8: 5.3 m	E39-R1: axial 3.7 m radial 2.4 m E39-R7: axial 4.2 m radial 2.7 m E39-R8: axial 5.3 m radial 3.1 m	E39-R1S: 4.3 m E39-R7: 4.8 m E39-R8: 5.6 m E39-R40: 4.3 m E39-RS3: 2 m	-			
Standard object	Opaque: 11 mm dia. min.		Opaque: 56 mm dia. min.			-			
Directional angle	3° to 20°		-			-			
Differential travel (hysteresis)	-		-			20% max.		5% max	
Black/white error	-		-			-		3%	
Response time	Operation and Reset: 2.5 ms max.				1 ms max	2.5 ms max.		1 ms max.	
Control output	Transistor (open collector), load current: 100 mA max. (residual voltage: 2 V max.)								
Power reset time	50 ms		100 ms max.		50 ms		100 ms		
Ambient illumination	Incandescent lamp: 3000 lx max. / Sunlight: 10000 lx max.								
Ambient temperature	Operating: -25 to 55 °C / Storage: -30 to 70 °C (with no icing or condensation)								
Ambient humidity	Operating: 35% to 85% / Storage: 35% to 95% (without condensation)								
Insulation resistance	20 M min. at 500 V DC between energized parts and case								
Dielectric strength	1000 VAC max., 50 / 60 Hz for 1 min between energized parts and case								
Vibration resistance	10 to 55 Hz, 1.5 mm double amplitude for 2 hrs each direction (X, Y, Z)								
Shock resistance	Destruction: 500 m/s <sup>2</sup> each direction (X, Y, Z)								
Enclosure ratings	IP67 [3.]; NEMA 1, 2, 4								
Light source	Infrared LED (880 nm/850 nm)			Red LED (660 nm)		Infrared LED (880 nm)			Red LED (660 nm)
Indicators	Light incident / power indicator for light source (red)	Output (orange) / light emission (red)	Light incident / power indicator for light source (red)		Light incident (red) / stability (green)	Light incident / power indicator for light source (red)		Light incident (red) / stability (green)	Output indicator (orange) / stability (green)
Sensitivity adjustment	Fixed				Fixed / Adjustable	Fixed	Adjustable		Fixed
Connection method	2 m, 5 m pre-wired cable (PVC, dia. 4 mm (18 / 0.12) [4.]) or M12-connector								
Test Input	-		[8.]	-		-			
Operation mode	Light-ON or Dark-ON selectable by wiring								
Weight (approx.)									
Plastic case	pre-wired (2 m)	120 g		60 g					
	connector	40 g		20 g					
Metal case	pre-wired (2 m)	180 g		90 g					
	connector	120 g		50 g					
Circuit protection	Output short-circuit and power supply reverse polarity								
Housing materials	Plastic (case: ABS; lens: PMMA)								
	Nickel brass	Nickel brass	-	Nickel brass	Nickel brass	Nickel brass	Nickel brass	Nickel brass	Nickel brass
	Stainless steel [5.]	-	-	Stainless steel [5.]	-	Stainless steel [5.]	Stainless steel [5.]	-	- [6.]

- Note: 1. For stable sensing distance in detail, please refer to "Engineering Data"  
 2. Typical sensing distance corresponds to 80 % of the max. sensing distance.  
 3. The enclosure rating IP67 of OMRON internal standards correspond to stricter test requirements than the standard IEC 60529 (refer to chapter "Precautions")  
 4. For other cable materials (e.g. PUR) please contact your OMRON sales representative.  
 5. Material-specification for stainless steel housing case: 1.4305 (W.-No.), 303 (AISI), 2346 (SS). For other stainless steel materials please contact your OMRON sales representative.  
 6. Please contact your OMRON sales representative for the availability of stainless steel BGS types.  
 7. with slit E39-ES18  
 8. PNP models -B4: Vcc to Vcc -2.5 V: Emitting OFF (Source current: 3 mA max.) / Open or 0 to 2.5 V: Emitting ON (Leakage current: 0.1 mA max.)  
 NPN models -C4: 0 to 2.5 V: Emitting OFF (Source current: 3 mA max.) / Open or Vcc to Vcc -2.5 V: Emitting ON (Leakage current: 0.1 mA max.)

Ratings / Characteristics of AC Switching Models

Item	E3F2-3Z1 E3F2-3Z2	E3F2-R2Z1 E3F2-R2Z2	E3F2-DS10Z1 E3F2-DS10Z2
Sensing method	Through-beam	Non-polarizing Retroreflective	Diffuse reflective (wide-beam characteristic)
Power supply voltage	24 to 240 VAC ±10 %, 50 / 60 Hz		
Current consumption	10 mA max.	5 mA max.	
Rated sensing distance[1.]	3 m	0.1 - 2 m (with reflector E39-R1)	0.1 m (5 x 5 cm white mat paper)
Typical sensing distance for different reflector types [2.]	–	E39-R1: 3,4 m E39-R7: 3,9 m E39-R8: 5,2 m	–
Detectable object	Opaque object: 11 mm min.	Opaque object: 56 mm min.	Opaque objects
Directional angle	3° to 20°		–
Differential travel	–		20 % max.
Response time	30 ms max.		
Control output	AC solid state (SCR) 200 mA max.; residual voltage: 5 V max. at 200 mA		
Power reset time	100 ms		
Ambient illumination	Incandescent lamp: 3000 lx max. Sunlight: 10000 lx max.		
Ambient temperature [5.]	Operating: -25 to 55 °C / Storage: -30 to 70 °C (with no icing or condensation)		
Ambient humidity	Operating: 35% to 85% / Storage: 35% to 95% (without condensation)		
Insulation resistance	20 M min. at 500 V DC between energized parts and case		
Dielectric strength	1500 VAC, 50 / 60 Hz for 1 min between energized parts and case		
Vibration resistance	10 to 55 Hz, 1.5 mm double amplitude for 2 hrs each direction (X, Y, Z)		
Shock resistance	500 m/sqr (approx. 50 g) for each direction (X, Y, Z)		
Enclosure rating	IP67 [3.]; NEMA 1, 2, 4		
Light source	Infrared LED (880 nm)		
Indicators	Light incident/power indicator for light source (red)		
Sensitivity adjustment	Fixed		
Connection method	2 m, 5 m pre-wired cable (PVC dia. 4 mm (14 / 0.15) [4.]		
Operation mode	Light-ON or Dark-ON (fixed)		
Circuit protection	None		
Weight (approx.)	110 g (pre-wired 2 m cable)		
Housing materials	Plastic (case: ABS; lens: PMMA)		

Note: 1. For stable sensing distance in detail, please refer to "Engineering Data"

2. Typical sensing distance corresponds to 80 % of the max. sensing distance.

3. The enclosure rating IP67 of OMRON internal standards correspond to stricter test requirements than the standard IEC 60529 (refer to chapter "Precautions")

4. For other cable materials (e.g. PUR) please contact your OMRON sales representative.

# Engineering Data (Typical)

## Operating Range (typical)

**Through-beam Models (axial)**  
E3F2-7□4-□

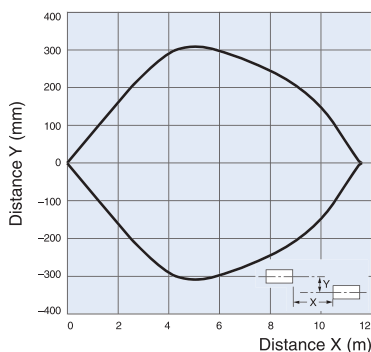

**Through-beam Models (axial)**  
E3F2-3Z□

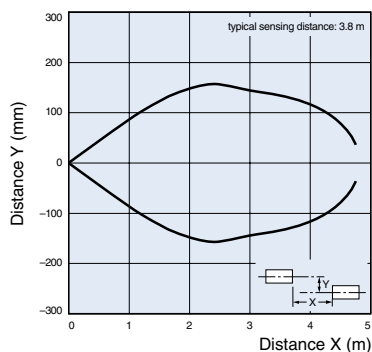

**Through-beam Models (axial)**  
E3F2-10□

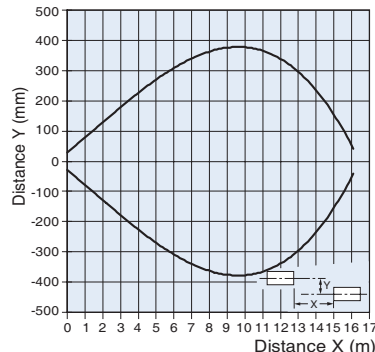

**Retroreflective Models (axial)**  
E3F2-R2□4-□ (non polarizing)  
and reflectors

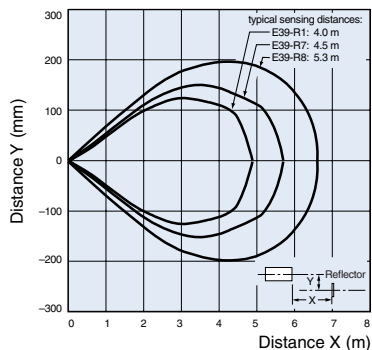

**Retroreflective Models (axial)**  
E3F2-R2Z□ (non polarizing)  
and reflectors

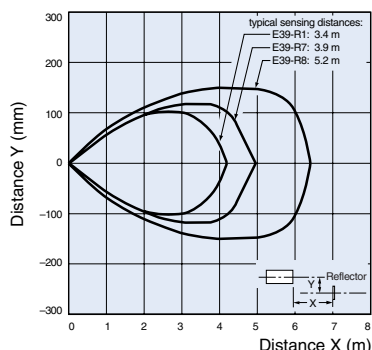

**Retroreflective Models (axial)**  
E3F2-R2R□4-□ (polarizing)  
and reflectors

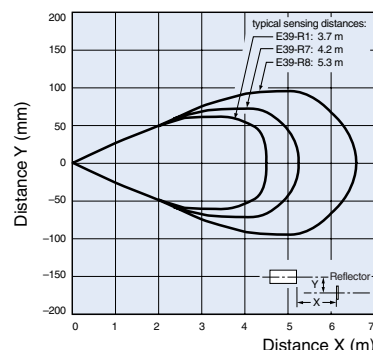

**Retro-reflective Models (axial)**  
E3F2-R4□4-□ (polarizing)

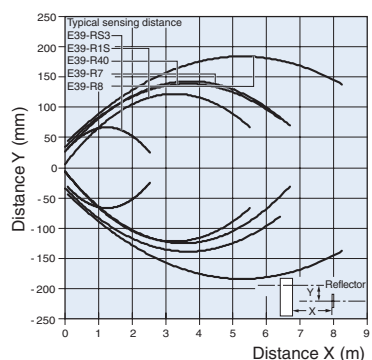

**Retroreflective Models (radial)**  
E3F2-R2R□41-□ (polarizing)  
and reflectors

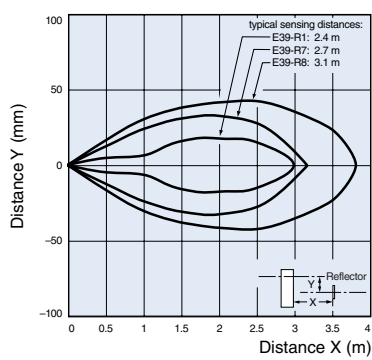

**Diffuse reflective Models (axial)**  
**E3F2-DS10□4□ (wide-beam type)**

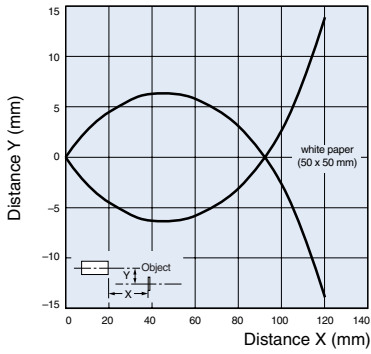

**Diffuse reflective Models (axial)**  
**E3F2-DS10Z□ (wide-beam type)**

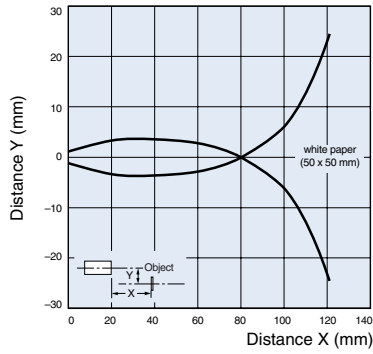

**Diffuse reflective Models (axial)**  
**E3F2-DS30□4□**

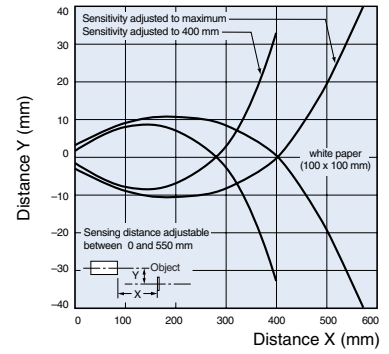

**Diffuse reflective Models (radial)**  
**E3F2-DS30□41□**

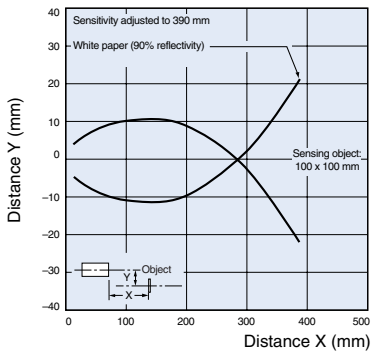

**Diffuse reflective Models (axial)**  
**E3F2-D1□4□**

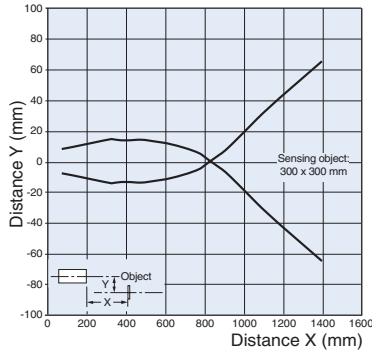

**Excess Gain Ratio vs. Distance (typical)**

**Through-beam Models (axial)**  
**E3F2-7□4□**

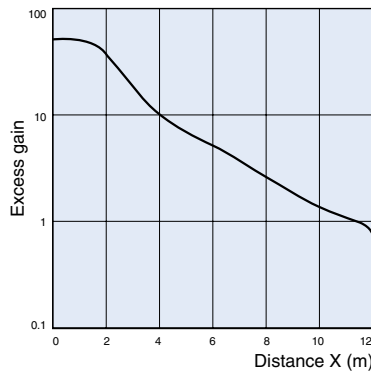

**Through-beam Models (axial)**  
**E3F2-3Z□**

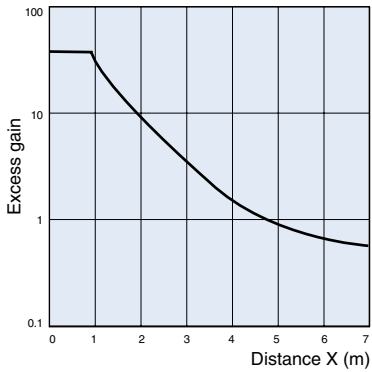

**Through-beam Models (axial)**  
**E3F2-10□**

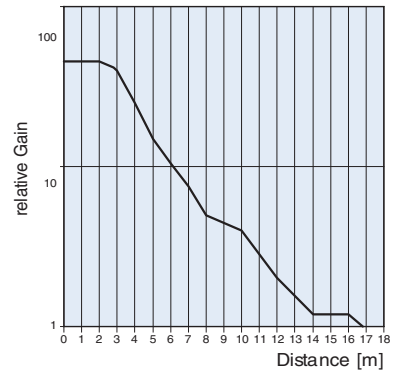

**Retroreflective Models (axial)  
E3F2-R2□4□ (non polarizing)  
and reflectors**

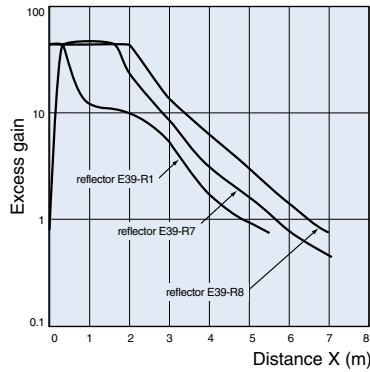

**Retroreflective Models (axial)  
E3F2-R2Z□ (non polarizing)  
and reflectors**

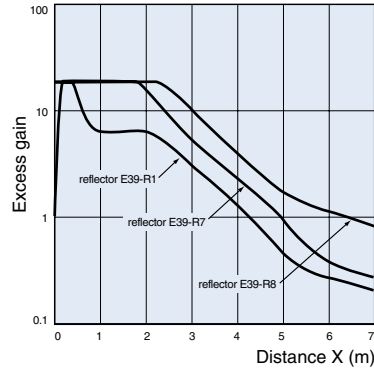

**Retroreflective Models (axial)  
E3F2-R2R□4□ (polarizing)  
and reflectors**

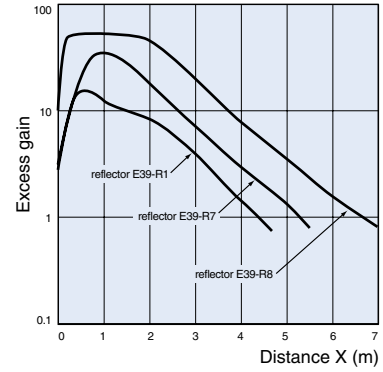

**Retroreflective Models (axial)  
E3F2-R4□4□**

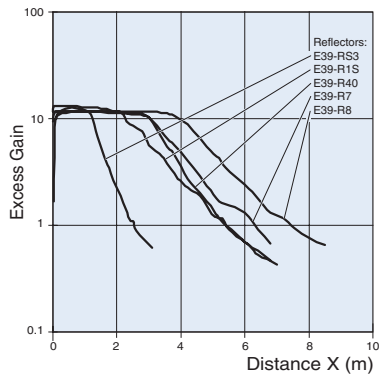

**Retroreflective Models (radial)  
E3F2-R2R□41□ (polarizing)  
and reflectors**

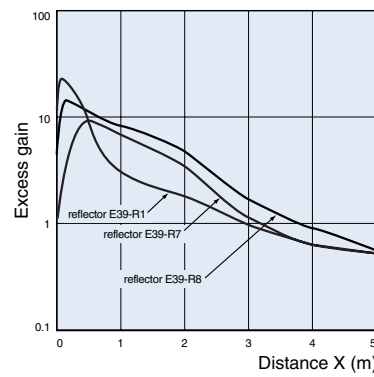

**Diffuse reflective Models (axial)  
E3F2-DS10□4□ (wide-beam type)**

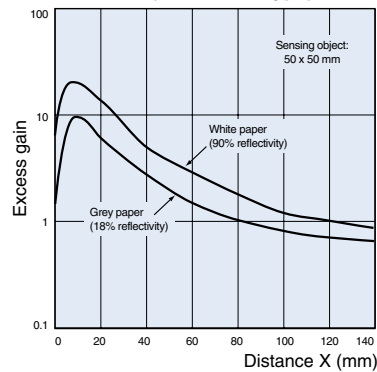

**Diffuse reflective Models (axial)  
E3F2-DS10Z□ (wide-beam type)**

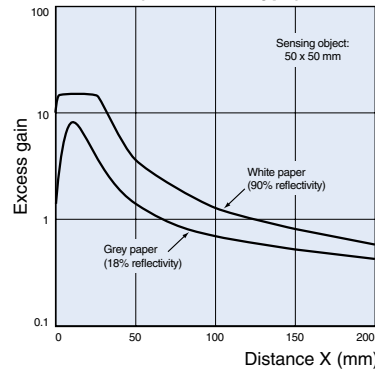

**Diffuse reflective Models (axial)  
E3F2-DS30□4□**

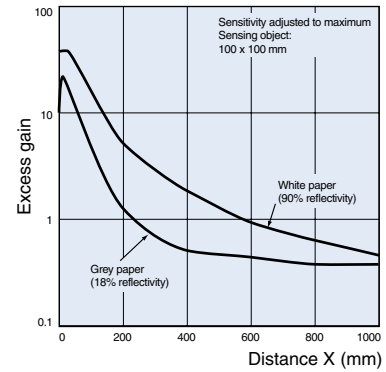

**Diffuse reflective Models (radial)**  
E3F2-DS30□41-□

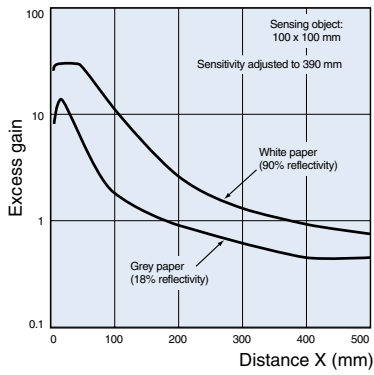

**Diffuse reflective Models (axial)**  
E3F2-D1□4-□

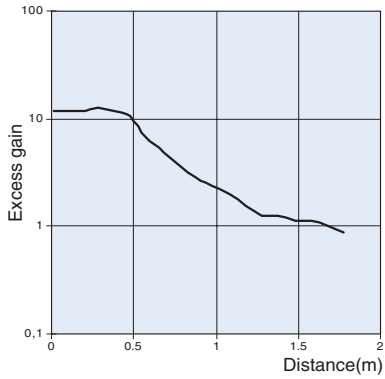

**Light spot vs sensing distance**

**Background suppression Models**  
E3F2-LS□

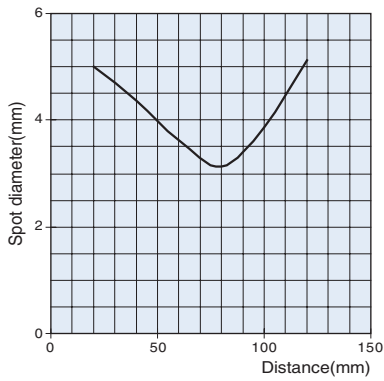

**Incline (left and right)**

**Background suppression Models**  
E3F2-LS□

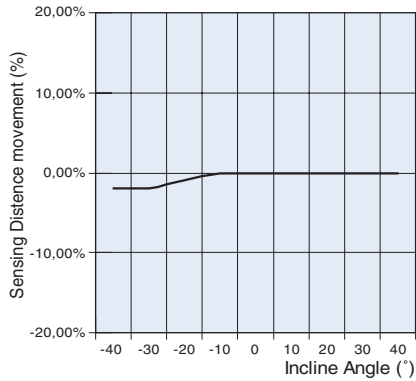

**Incline (up and down)**

**Background suppression Models**  
E3F2-LS□

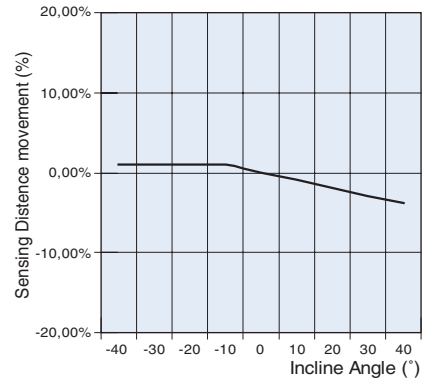

**Object material vs sensing distance**

**Background suppression Models**  
E3F2-LS□

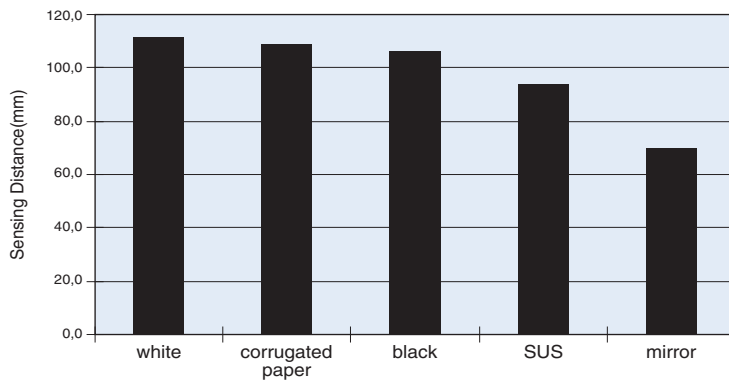

# Operation

## Output Circuits

### Structure of Sensor I/O Connector

Classification	Wire color	Connector pin No.	Use
DC	Brown	①	Power supply (+V)
	White	②	Mode selection Lon/Don
	Blue	③	Power supply (0 V)
	Black	④	Output

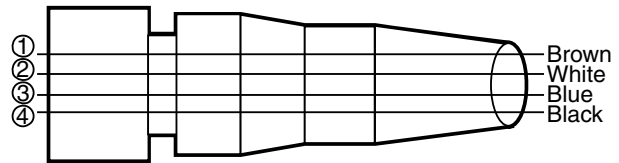

XS2F-D42□-D80-□

XS2F-G42□-G80-□

### PNP Output

Model	Output transistor status	Timing chart	Connection method	Output circuit
E3F2-□B4-□ (except for E3F2-10B4-□ and E3F2-LS10B4-□)				<p>Through-beam emitter</p> <p>Connector Pin Arrangement</p>
	ON when light is incident. (Light-ON)	<p>Incident Interrupted</p> <p>Output indicator (red) ON OFF</p> <p>Output transistor ON OFF</p> <p>Load (relay) Operate Release</p>	<p>Connect the pink (Pin ②) and brown (Pin ①) cords or open the pink cord (Pin ②).</p>	<p>Connector Pin Arrangement</p> <p>* Only on models E3F2-R4B4-□ and E3F2-D1B4-□</p>
	ON when light is interrupted. (Dark-ON)	<p>Incident Interrupted</p> <p>Output indicator (red) ON OFF</p> <p>Output transistor ON OFF</p> <p>Load (relay) Operate Release</p>	<p>Connect the pink (Pin ②) and blue (Pin ③) cords.</p>	<p>Connector Pin Arrangement</p> <p>* Only on models E3F2-R4B4-□ and E3F2-D1B4-□</p>



Model	Output transistor status	Timing chart	Connection method	Output circuit
E3F2-10B4-□		<p>Test input</p> <p>Light emission</p> <p>Indicator</p>		<p>Through-beam emitter</p>
	ON when light is incident. (Light-ON)	<p>Incident Interrupted</p> <p>Output indicator (orange)</p> <p>Output transistor</p> <p>Load (relay)</p>	Connect the pink (Pin ②) and brown (Pin ①) cords or open the pink cord (Pin ②).	<p><b>Connector Pin Arrangement</b></p>
	ON when light is interrupted. (Dark-ON)	<p>Incident Interrupted</p> <p>Output indicator (orange)</p> <p>Output transistor</p> <p>Load (relay)</p>	Connect the pink (Pin ②) and blue (Pin ③) cords.	<p><b>Connector Pin Arrangement</b></p>
E3F2-LS10B4-□	ON when light is incident. (Light-ON)	<p>Incident Interrupted</p> <p>Output indicator (orange)</p> <p>Output transistor</p> <p>Load (relay)</p>	Connect the pink (Pin ②) and brown (Pin ①) cords or open the pink cord (Pin ②).	<p><b>Connector Pin Arrangement</b></p>
	ON when light is interrupted. (Dark-ON)	<p>Incident Interrupted</p> <p>Output indicator (orange)</p> <p>Output transistor</p> <p>Load (relay)</p>	Connect the pink (Pin ②) and blue (Pin ③) cords.	<p><b>Connector Pin Arrangement</b></p>

Note: Terminal numbers for connector type.

NPN Output

Model	Output transistor status	Timing chart	Connection method	Output circuit
E3F2-□C4-□ (except for E3F2-10C4-□ and E3F2-LS10C4-□)	-	-	-	<p>Through-beam emitter</p> <p>Connector Pin Arrangement</p>
	ON when light is incident. (Light-ON)	<p>Incident Interrupted</p>	Connect the pink (Pin ②) and brown (Pin ①) cords or open the pink cord (Pin ②).	<p>Connector Pin Arrangement</p> <p>* Only on models E3F2-R4C4-□ and E3F2-D1C4-□</p>
	ON when light is interrupted. (Dark-ON)	<p>Incident Interrupted</p>	Connect the pink (Pin ②) and blue (Pin ③) cords.	<p>Connector Pin Arrangement</p> <p>* Only on models E3F2-R4C4-□ and E3F2-D1C4-□</p>
E3F2-10C4-□	-	<p>Test input</p>	-	<p>Through-beam emitter</p>
	ON when light is incident. (Light-ON)	<p>Incident Interrupted</p>	Connect the pink (Pin ②) and brown (Pin ①) cords or open the pink cord (Pin ②).	<p>Connector Pin Arrangement</p>
	ON when light is interrupted. (Dark-ON)	<p>Incident Interrupted</p>	Connect the pink (Pin ②) and blue (Pin ③) cords.	<p>Connector Pin Arrangement</p>

Model	Output transistor status	Timing chart	Connection method	Output circuit
E3F2-LS10C4-□	ON when light is incident. (Light-ON)		Connect the pink (Pin ②) and brown (Pin ①) cords or open the pink cord (Pin ②).	<p>Connector Pin Arrangement</p>
	ON when light is interrupted. (Dark-ON)		Connect the pink (Pin ②) and blue (Pin ③) cords.	<p>Connector Pin Arrangement</p>

Note: Terminal numbers for connector type.

AC Output

Model	Output transistor status	Timing chart	Connection method	Output circuit
E3F2-3LZ	—	—	—	<p>Through-beam emitter</p>
E3F2-3Z1 E3F2-R2Z1 E3F2-DS10Z1-N	ON when light is incident. (Light-ON)		—	
E3F2-3Z2 E3F2-R2Z2 E3F2-DS10Z2-N	ON when light is interrupted. (Dark-ON)		—	

Dimensions Note: All units are in millimeters unless otherwise indicated

DC-Switching Models, plastic, axial type

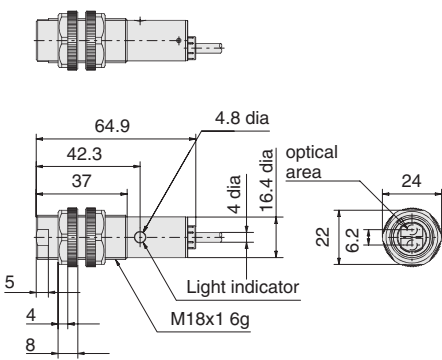
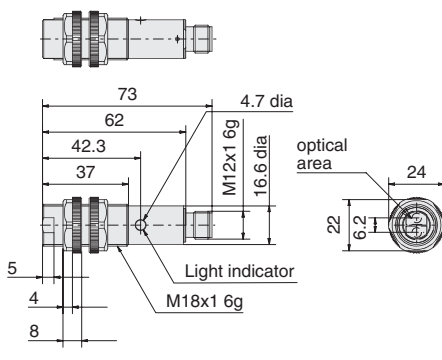
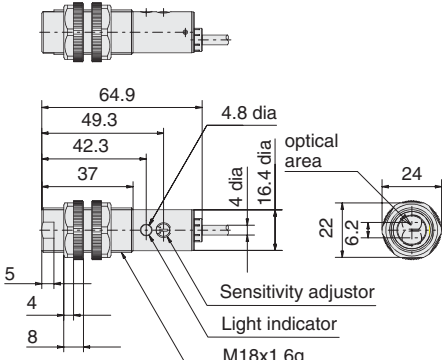
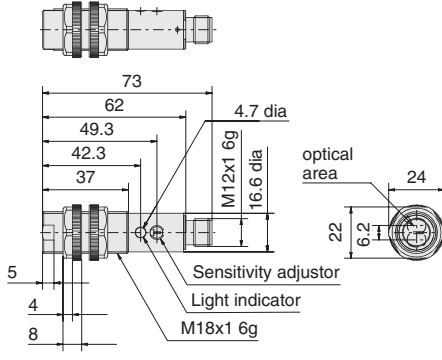
Cable type	Connector type
<p>Without potentiometer</p> <p><b>E3F2-7□</b>  <b>E3F2-10□</b>  <b>E3F2-R2□4</b>  <b>E3F2-DS10□4-N</b>  <b>E3F2-LS10□4</b>  <b>E3F2-R4□4F</b></p> 	<p><b>E3F2-7□-P1</b>  <b>E3F2-10□-P1</b>  <b>E3F2-R2□4-P1</b>  <b>E3F2-DS10□4-P1</b>  <b>E3F2-LS10□4-P1</b>  <b>E3F2-R4□4F-P1</b></p> 
<p>With potentiometer</p> <p><b>E3F2-DS30□4</b>  <b>E3F2-D1□4</b></p> 	<p><b>E3F2-DS30□4-P1</b>  <b>E3F2-D1□4-P1</b></p> 

DC-Switching Models, plastic, radial type

Cable type	Connector type
<p>Without potentiometer</p> <p><b>E3F2-R2R□41</b></p>	<p><b>E3F2-R2R□41-P1</b></p>
<p>With potentiometer</p> <p><b>E3F2-DS30□41</b></p>	<p><b>E3F2-DS30□41-P1</b></p>

DC-Switching Models, metal (brass and stainless steel), axial type

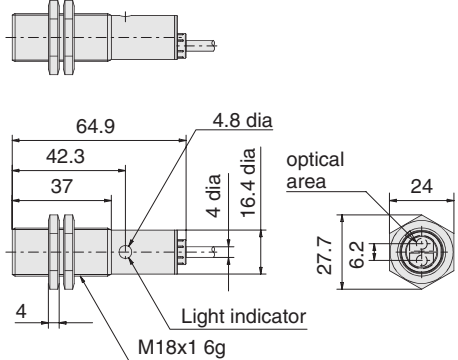
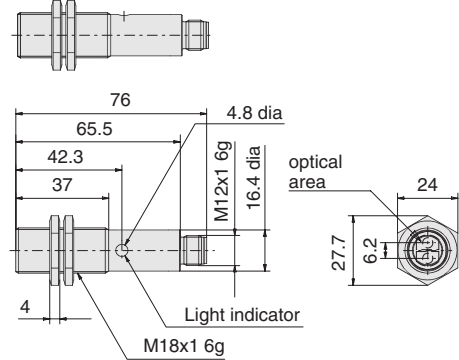
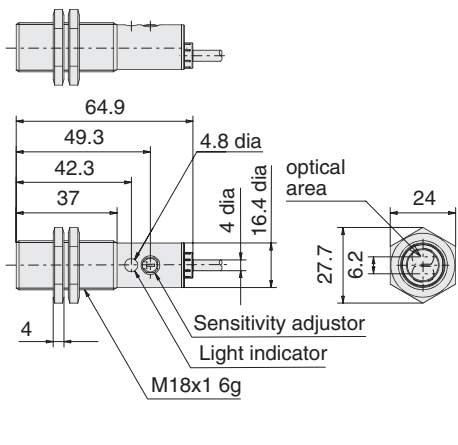
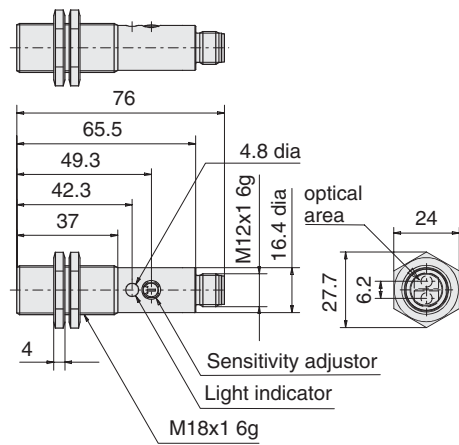
Cable type	Connector type
Without potentiometer	
<p> <b>E3F2-7□-M</b>      <b>E3F2-7□-S</b>  <b>E3F2-10□-M</b>  <b>E3F2-R2R□4-M</b>      <b>E3F2-R2R□4-S</b>  <b>E3F2-DS10□4-M</b>      <b>E3F2-DS10□4-S</b>  <b>E3F2-LS10□4-M</b>  <b>E3F2-R4□4F-M</b> </p> 	<p> <b>E3F2-7□-M1-M</b>      <b>E3F2-7□-M1-S</b>  <b>E3F2-10□-M1-M</b>  <b>E3F2-R2R□4-M1-M</b>      <b>E3F2-R2R□4-M1-S</b>  <b>E3F2-DS10□4-M1-M</b>      <b>E3F2-DS10□4-M1-S</b>  <b>E3F2-LS10□4-M1-M</b>  <b>E3F2-R4□4F-M1-M</b> </p> 
With potentiometer	
<p> <b>E3F2-DS30□4-M</b>      <b>E3F2-DS30□4-S</b>  <b>E3F2-R4□4-M</b>  <b>E3F2-D1□4-M</b> </p> 	<p> <b>E3F2-DS30□4-M1-M</b>      <b>E3F2-DS30□4-M1-S</b>  <b>E3F2-R4□4-M1-M</b>  <b>E3F2-D1□4-M1-M</b> </p> 

DC-Switching Models, metal (brass and stainless steel), radial type

Cable type		Connector type	
Without potentiometer			
<b>E3F2-R2R□41-M</b>	<b>E3F2-R2R□41-S</b>	<b>E3F2-R2R□41-M1</b>	<b>E3F2-R2R□41-M1-S</b>
With potentiometer			
<b>E3F2-DS30□41-M</b>	<b>E3F2-DS30□41-S</b>	<b>E3F2-DS30□41-M1-M</b>	<b>E3F2-DS30□41-M1-S</b>

AC-Switching Models, plastic, axial type

Cable type	
Without potentiometer	
<b>E3F2-3Z□</b>	<b>E3F2-R2Z□</b>
<b>E3F2-DS10Z□-N</b>	

Accessories (Order Separately)

Reflectors

**E39-R1**  
**E39-R1S**



Material, reflective surface: acrylic  
Rear surface: ABS

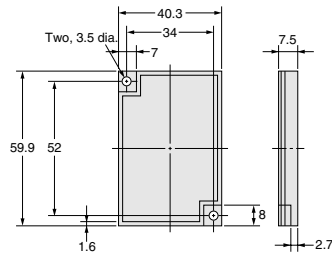

**E39-R3**



Material, reflective surface: acrylic  
Rear surface: ABS

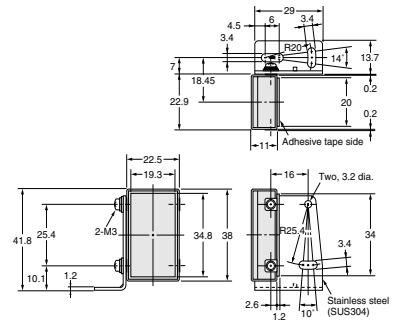

**E39-R7**

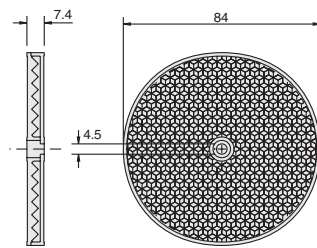

**E39-R8**

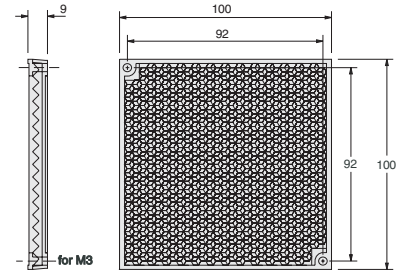
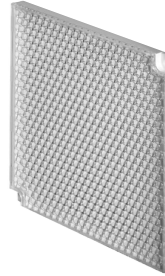

**E39-R40**

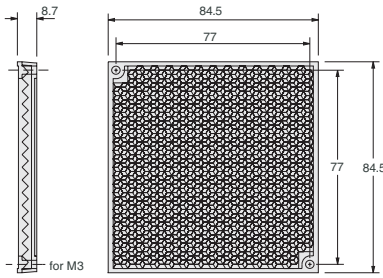

Tape Reflectors

**E39-RS3**

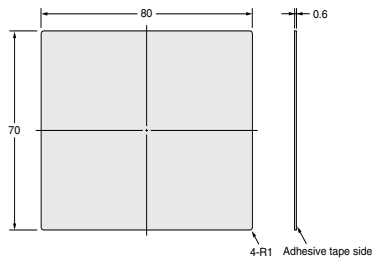
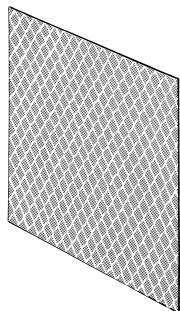

**E39-RSA**

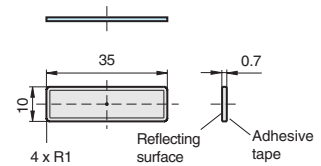

**E39-RSB**

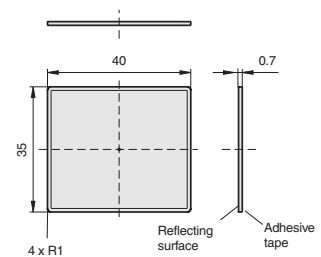
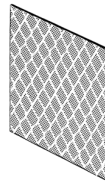



Installation

**Mounting Bracket  
Y92E-B18**

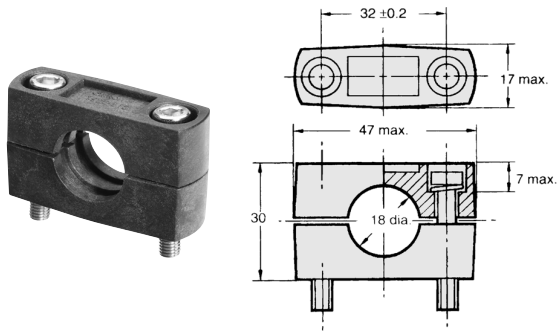

**Note:**  
Hexagon bolt: M5 x 32  
Material: plastic

**Lens Cap  
E39-F31**

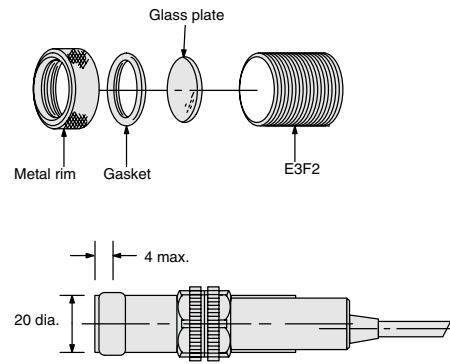

**Mounting Bracket  
Y92E-G18**

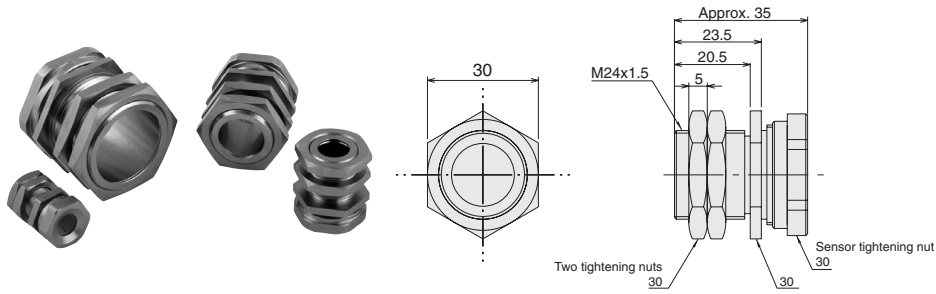

**Slit (for precision detection with E3F2-10□)  
E39-ES18**

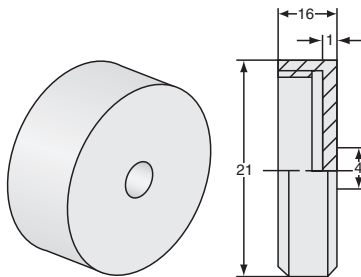

## Precautions

The E3F2 Photoelectric Sensor is not a safety component for ensuring the safety of people which is defined in EC directive (91/368/EEC) and covered by separate European standards or by any other regulations or standards.

### Degree of protection

The E3F2 photoelectric sensors have a degree of protection rated with IP67. In this case, the sensors have passed the OMRON heat shock test before the IP67-test of IEC 60529 (submersion at 1m water depth for 30 min). Afterwards the sensors have been tested according to the OMRON waterproof test.

**Heat shock:** Alternating, fast temperature changes between -25°C and +55°C are executed for 5 cycles and 1 hour for each temperature. Function and isolation are checked.

**Water proof:** The sensors are submerged alternating in water of +2°C and +55°C. 20 cycles with 1 hour for each temperature are executed. Function, water tightness and electrical isolation are checked.

Do not expose the photoelectric sensor to excessive shock during installation, keeping within IP 67 standards.

### Wiring

If the input/output lines of the photoelectric sensor are placed in the same conduit or duct as power lines or high-voltage lines, the photoelectric sensor could be induced to malfunction, or even be damaged by electrical noise. Separate the wiring, or use shielded lines as input/output lines to the photoelectric sensor.

Do not connect the black wire to the brown wire without a load. Direct connection of these wires may damage the photoelectric sensor (AC switching type).

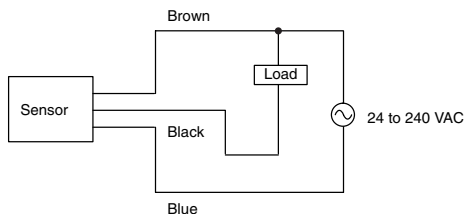

When using the photoelectric sensor in the vicinity of an inverter motor, ensure to connect the protective earth ground wire of the motor to earth. Failure to ground the motor may result in malfunction of the sensor.

When you use the photoelectric sensor at temperatures exceeding 45°C, the load current must be within the described values as shown in the figure below.

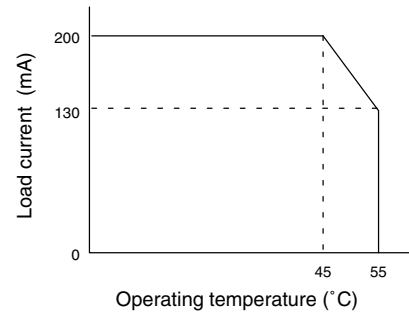

### Installation

Do not exceed a torque of

- 2.0 Nm ( 20 kgf cm) when tightening mounting nuts for plastic models
- 20.0 Nm (200 kgf cm) when tightening mounting nuts for metal models

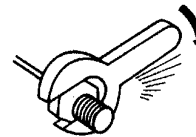



Cat. No. E224-E2-02

In the interest of product improvement, specifications are subject to change without notice.

---

**OMRON EUROPE B.V.**

Wegalaan 67-69,  
NL-2132 JD, Hoofddorp,  
The Netherlands  
Phone: +31 23 568 13 00  
Fax: +31 23 568 13 88  
[www.eu.omron.com](http://www.eu.omron.com)