

- Easy mounting and removal of Switch Unit.
- Increase wiring efficiency with three-row mounting of Switch Blocks.
- Finger protection mechanism on Switch Unit provided as a standard feature.
- Mounted using either open-type (fork-type) or closed-type (round-type) crimp terminals.
- IP65 oil resistance (non-lighted models)
IP65 (lighted models)
EN60947-5-1



Ordering Information

Model Number Legend

The model numbers used to order sets of Units are illustrated below. One set comprises the Pushbutton, Lamp (lighted models only), and Switch.

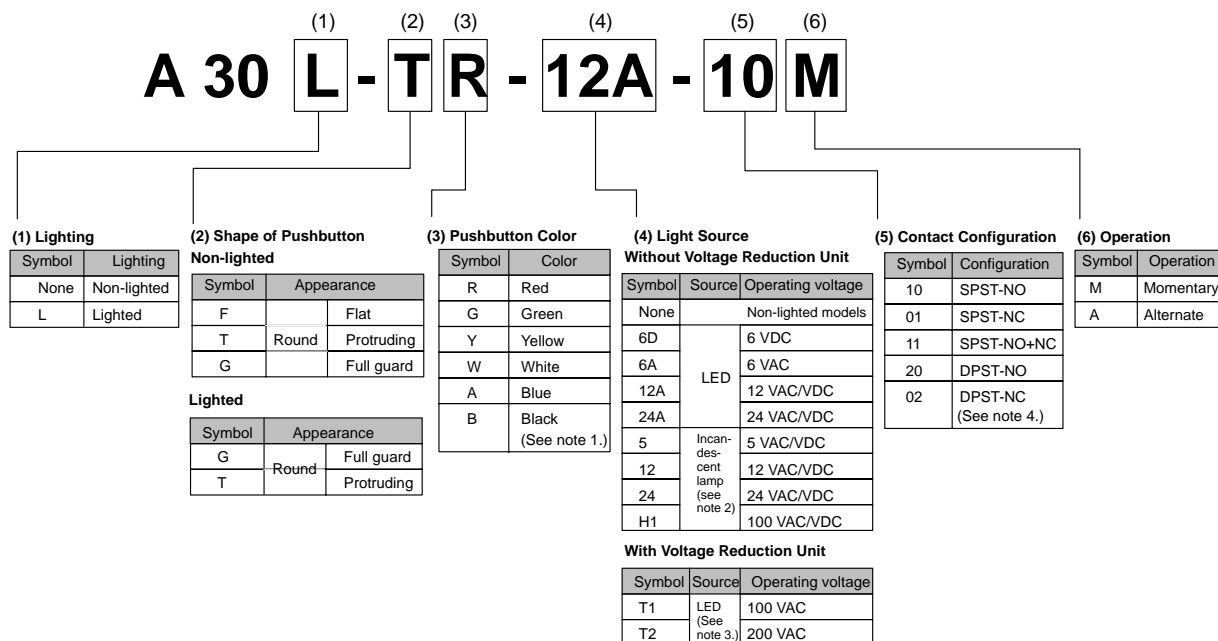

- Note:**
1. Non-lighted models only.
 2. Super-bright LEDs can only be ordered individually.
 3. 24-VAC/VDC LEDs are built-in.
 4. For the contact ratings, refer to page 214.

■ List of Models

Pushbutton Switches (Non-lighted Models)

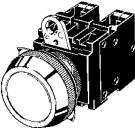
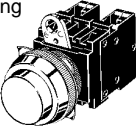
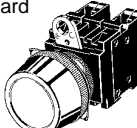
Model	A30-F	A30-T	A30-G
Shape	Round		
	Flat 	Protruding 	Full guard 

Pushbutton Switches (Lighted Models)

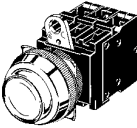
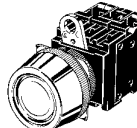
Model	A30L-T	A30L-G
Shape	Round	
	Protruding 	Full guard 

■ Ordering as a Set

Shipped as a set which includes the Pushbutton, Lamp (lighted models only), and Switch.

Non-lighted Models (Round)

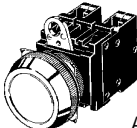
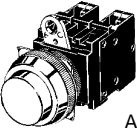
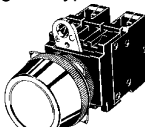
Appearance	Output	Momentary operation (self-resetting)	Alternate operation (self-holding)	Illumination color
Flat type  A30-F	SPST-NO	A30-F□-10M	A30-F□-10A	Insert one of the following letters into the box □. R (red) Y (yellow) G (green) W (white) A (blue) B (black)
	SPST-NC	A30-F□-01M	A30-F□-01A	
	SPST-NO + NC	A30-F□-11M	A30-F□-11A	
	DPST-NO	A30-F□-20M	A30-F□-20A	
	DPST-NC	A30-F□-02M	A30-F□-02A	
Protruding type  A30-T	SPST-NO	A30-T□-10M	A30-T□-10A	
	SPST-NC	A30-T□-01M	A30-T□-01A	
	SPST-NO + NC	A30-T□-11M	A30-T□-11A	
	DPST-NO	A30-T□-20M	A30-T□-20A	
	DPST-NC	A30-T□-02M	A30-T□-02A	
Full guard type  A30-G	SPST-NO	A30-G□-10M	A30-G□-10A	
	SPST-NC	A30-G□-01M	A30-G□-01A	
	SPST-NO + NC	A30-G□-11M	A30-G□-11A	
	DPST-NO	A30-G□-20M	A30-G□-20A	
	SPST-NC	A30-G□-02M	A30-G□-02A	

Lighted Models (Round)

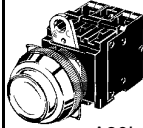
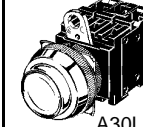
Appearance	Output	Lighting	Rated voltage	Momentary operation (self-resetting)	Alternate operation (self-holding)	Illumination color
Protruding models LED-lighting without Voltage Reduction Unit  A30L-T	SPST-NO	LED	6 VDC	A30L-T□-6D-10M	A30L-T□-6D-10A	Insert one of the following letters into the box □. R (red) Y (yellow) G (green) W (white) A (blue)
			6 VAC	A30L-T□-6A-10M	A30L-T□-6A-10A	
			12 VDC/VAC	A30L-T□-12A-10M	A30L-T□-12A-10A	
			24 VDC/VAC	A30L-T□-24A-10M	A30L-T□-24A-10A	
	SPST-NC		6 VDC	A30L-T□-6D-01M	A30L-T□-6D-01A	
			6 VAC	A30L-T□-6A-01M	A30L-T□-6A-01A	
			12 VDC/VAC	A30L-T□-12A-01M	A30L-T□-12A-01A	
			24 VDC/VAC	A30L-T□-24A-01M	A30L-T□-24A-01A	
	SPST-NO + NC		6 VDC	A30L-T□-6D-11M	A30L-T□-6D-11A	
			6 VAC	A30L-T□-6A-11M	A30L-T□-6A-11A	
			12 VDC/VAC	A30L-T□-12A-11M	A30L-T□-12A-11A	
			24 VDC/VAC	A30L-T□-24A-11M	A30L-T□-24A-11A	
	DPST-NO		6 VDC	A30L-T□-6D-20M	A30L-T□-6D-20A	
			6 VAC	A30L-T□-6A-20M	A30L-T□-6A-20A	
			12 VDC/VAC	A30L-T□-12A-20M	A30L-T□-12A-20A	
			24 VDC/VAC	A30L-T□-24A-20M	A30L-T□-24A-20A	
	DPST-NC		6 VDC	A30L-T□-6D-02M	A30L-T□-6D-02A	
			6 VAC	A30L-T□-6A-02M	A30L-T□-6A-02A	
			12 VDC/VAC	A30L-T□-12A-02M	A30L-T□-12A-02A	
			24 VDC/VAC	A30L-T□-24A-02M	A30L-T□-24A-02A	
Protruding models LED reduced-voltage lighting with Voltage Reduction Unit  A30L-T	SPST-NO	100 VAC	A30L-T□-T1-10M	A30L-T□-T1-10A		
		200 VAC	A30L-T□-T2-10M	A30L-T□-T2-10A		
	SPST-NC	100 VAC	A30L-T□-T1-01M	A30L-T□-T1-01A		
		200 VAC	A30L-T□-T2-01M	A30L-T□-T2-01A		
	SPST-NO + NC	100 VAC	A30L-T□-T1-11M	A30L-T□-T1-11A		
		200 VAC	A30L-T□-T2-11M	A30L-T□-T2-11A		
	DPST-NO	100 VAC	A30L-T□-T1-20M	A30L-T□-T1-20A		
		200 VAC	A30L-T□-T2-20M	A30L-T□-T2-20A		
	DPST-NC	100 VAC	A30L-T□-T1-02M	A30L-T□-T1-02A		
		200 VAC	A30L-T□-T2-02M	A30L-T□-T2-02A		

Lighted Models (Round)

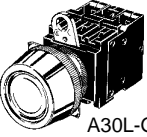
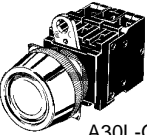
Appearance	Output	Lighting	Rated voltage	Momentary operation (self-resetting)	Alternate operation (self-holding)	Illumination color
Full guard models LED-lighting without Voltage Reduction Unit  A30L-G	SPST-NO	LED	6 VDC	A30L-G□-6D-10M	A30L-G□-6D-10A	Insert one of the following letters into the box □. R (red) Y (yellow) G (green) W (white) A (blue)
			6 VAC	A30L-G□-6A-10M	A30L-G□-6A-10A	
			12 VDC/VAC	A30L-G□-12A-10M	A30L-G□-12A-10A	
			24 VDC/VAC	A30L-G□-24A-10M	A30L-G□-24A-10A	
	SPST-NC		6 VDC	A30L-G□-6D-01M	A30L-G□-6D-01A	
			6 VAC	A30L-G□-6A-01M	A30L-G□-6A-01A	
			12 VDC/VAC	A30L-G□-12A-01M	A30L-G□-12A-01A	
			24 VDC/VAC	A30L-G□-24A-01M	A30L-G□-24A-01A	
	SPST-NO + NC		6 VDC	A30L-G□-6D-11M	A30L-G□-6D-11A	
			6 VAC	A30L-G□-6A-11M	A30L-G□-6A-11A	
			12 VDC/VAC	A30L-G□-12A-11M	A30L-G□-12A-11A	
			24 VDC/VAC	A30L-G□-24A-11M	A30L-G□-24A-11A	
	DPST-NO		6 VDC	A30L-G□-6D-20M	A30L-G□-6D-20A	
			6 VAC	A30L-G□-6A-20M	A30L-G□-6A-20A	
			12 VDC/VAC	A30L-G□-12A-20M	A30L-G□-12A-20A	
			24 VDC/VAC	A30L-G□-24A-20M	A30L-G□-24A-20A	
DPST-NC	6 VDC	A30L-G□-6D-02M	A30L-G□-6D-02A			
	6 VAC	A30L-G□-6A-02M	A30L-G□-6A-02A			
	12 VDC/VAC	A30L-G□-12A-02M	A30L-G□-12A-02A			
	24 VDC/VAC	A30L-G□-24A-02M	A30L-G□-24A-02A			
Full guard models LED reduced-voltage lighting with Voltage Reduction Unit  A30L-G	SPST-NO	100 VAC	A30L-G□-T1-10M	A30L-G□-T1-10A		
		200 VAC	A30L-G□-T2-10M	A30L-G□-T2-10A		
	SPST-NC	100 VAC	A30L-G□-T1-01M	A30L-G□-T1-01A		
		200 VAC	A30L-G□-T2-01M	A30L-G□-T2-01A		
	SPST-NO + NC	100 VAC	A30L-G□-T1-11M	A30L-G□-T1-11A		
		200 VAC	A30L-G□-T2-11M	A30L-G□-T2-11A		
	DPST-NO	100 VAC	A30L-G□-T1-20M	A30L-G□-T1-20A		
		200 VAC	A30L-G□-T2-20M	A30L-G□-T2-20A		
	DPST-NC	100 VAC	A30L-G□-T1-02M	A30L-G□-T1-02A		
		200 VAC	A30L-G□-T2-02M	A30L-G□-T2-02A		

■ Ordering Individually

Pushbuttons, Lamps, and Switches can be ordered separately. Combinations that are not available as sets can be created using individual Units. Also, store the parts as spares for maintenance and repairs.

Non-lighted Models

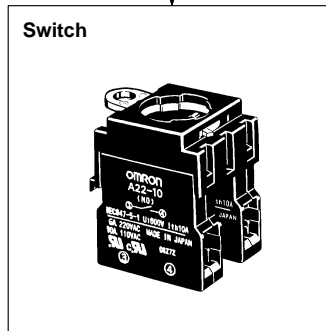
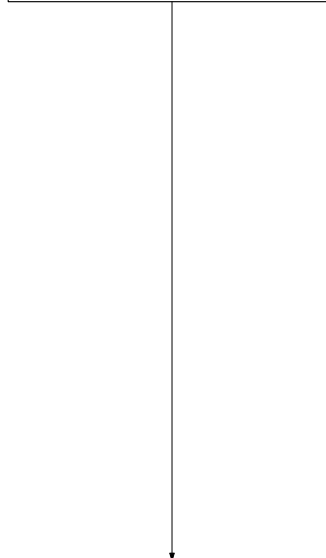
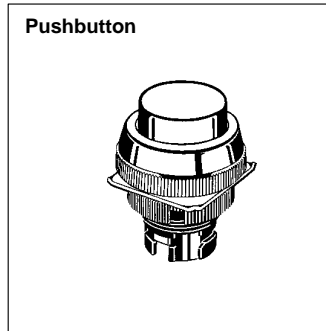

Lighted Models without Voltage Reduction Unit

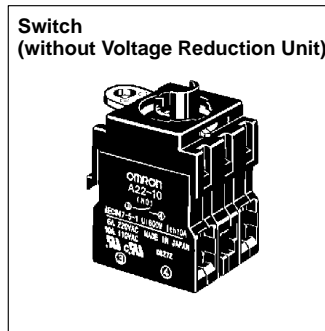
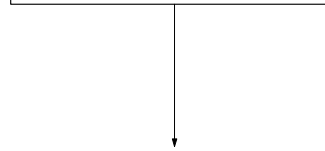
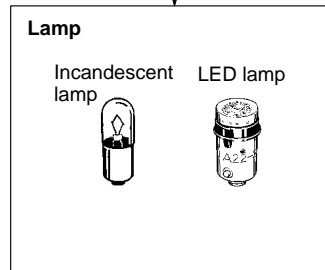
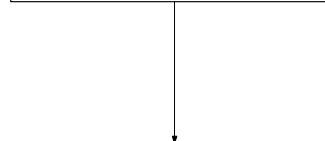
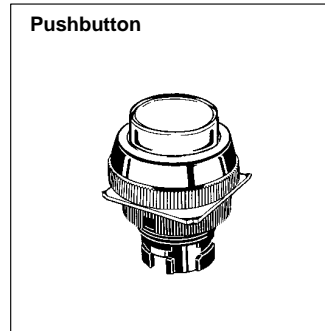

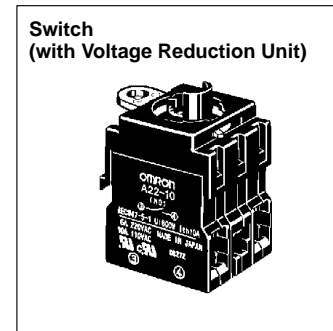
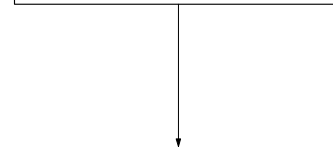
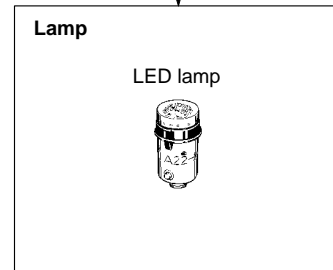
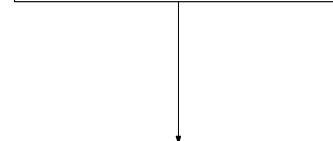
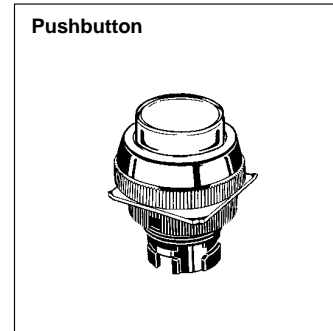

Lighted Models with Voltage Reduction Unit



■ Pushbutton Switches (Subassembly)

Pushbutton

Non-lighted Models

Sealant	IP65 oil-resistant models		
	Flat	Protruding	Full guard
Appearance			
Pushbutton color			
Red	A30-FR	A30-TR	A30-GR
Green	A30-FG	A30-TG	A30-GG
Yellow	A30-FY	A30-TY	A30-GY
White	A30-FW	A30-TW	A30-GW
Blue	A30-FA	A30-TA	A30-GA
Black	A30-FB	A30-TB	A30-GB

Lighted Models

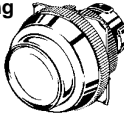
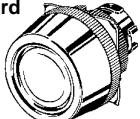
Sealant	IP65	
	Protruding	Full guard
Appearance		
Pushbutton color		
Red	A30L-TR	A30L-GR
Green	A30L-TG	A30L-GG
Yellow	A30L-TY	A30L-GY
White	A30L-TW	A30L-GW
Blue	A30L-TA	A30L-GA

Note: Common to incandescent lamps and LED lamps.

Lamp

LED Lamps

Appearance	Rated voltage	Color	6 V	12 V	24 V	Super-bright 24 V
	DC	Red	A22-6DR	---	---	---
		Green	A22-6DG	---	---	---
		Yellow (See note 2.)	A22-6DY	---	---	---
		Blue	A22-6DA	---	---	---
	AC	Red	A22-6AR	---	---	---
		Green	A22-6AG	---	---	---
		Yellow (See note 2.)	A22-6AY	---	---	---
		Blue	A22-6AA	---	---	---
	AC/DC	Red	---	A22-12AR	A22-24AR	A22-24ASR
		Green	---	A22-12AG	A22-24AG	A22-24ASG
		Yellow (See note 2.)	---	A22-12AY	A22-24AY	A22-24ASY
		Blue	---	A22-12AA	A22-24AA	A22-24ASA

Note: 1. If using low-voltage lighting, select A22-24A□ models.

2. Select if the Pushbutton is yellow or white.

Incandescent Lamp

Rated voltage	6 VDC/VAC	14 VDC/VAC	28 VDC/VAC	130 VDC/VAC
Appearance				
	A22-5	A22-12	A22-24	A22-H1

Switch (Standard Load)

Without Low Voltage Unit





	Classification	Non-lighted		Lighted	
		Appearance		Appearance	
		Operation		Operation	
Contact configuration		Momentary	Alternate	Momentary	Alternate
Standard load	SPST-NO	A22-10M	A22-10A	A22L-10M	A22L-10A
	SPST-NC	A22-01M	A22-01A	A22L-01M	A22L-01A
	SPST-NO + NC	A22-11M	A22-11A	A22L-11M	A22L-11A
	DPST-NO	A22-20M	A22-20A	A22L-20M	A22L-20A
	DPST-NC	A22-02M	A22-02A	A22L-02M	A22L-02A

With Low Voltage Unit

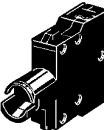
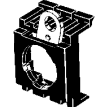

	Classification	Lighted 110 VAC		Lighted 220 VAC	
		Appearance		Appearance	
		Operation		Operation	
Contact configuration		Momentary	Alternate	Momentary	Alternate
Standard load	SPST-NO	A22L-10M-T1	A22L-10A-T1	A22L-10M-T2	A22L-10A-T2
	SPST-NC	A22L-01M-T1	A22L-01A-T1	A22L-01M-T2	A22L-01A-T2
	SPST-NO + NC	A22L-11M-T1	A22L-11A-T1	A22L-11M-T2	A22L-11A-T2
	DPST-NO	A22L-20M-T1	A22L-20A-T1	A22L-20M-T2	A22L-20A-T2
	DPST-NC	A22L-02M-T1	A22L-02A-T1	A22L-02M-T2	A22L-02A-T2

Note: The diagrams show a typical DPST-NO configuration. If using a Low Voltage Unit, select A22-24A□ models.

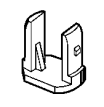
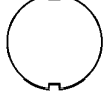
■ Accessories (Order Separately)

Name	Appearance	Classification		Model	Remarks
Switch Blocks		SPST-NO	Standard load	A22-10	Equipped as standard. Use when adding or replacing Switch Blocks.
			Microload	A22-10S	
		SPST-NC	Standard load	A22-01	
			Microload	A22-01S	
		DPST-NO	Standard load	A22-20	
			Microload	A22-20S	
		DPST-NC	Standard load	A22-02	
			Microload	A22-02S	
DPST-NO + NC		Standard load	A22-11		
		Microload	A22-11S		
Lamp Socket		Direct lighting		A22-TN	Use to change lighting method.
		Low-voltage lighting	100 VAC	A22-T1	
			200 VAC	A22-T2	
Mounting Board		Momentary operation		A22-3200	Use when purchasing and mounting individual Switch Blocks and lighting units.
		Alternate operation		A22-3210	
Colored Cap		Red		A22Z-30TR	Use to change the color of the Pushbutton of (round) lighted Pushbutton Switches.
		Green		A22Z-30TG	
		Yellow		A22Z-30TY	
		White		A22Z-30TW	
		Blue		A22Z-30TA	
3-unit Spacer		---		A22Z-3003	Use to mount 3 Switch Blocks on a non-lighted Pushbutton Switch. You cannot use emergency stop, Knob-type Selector Switch, or Key-type Selector Switches. Refer to page 220 for details.
Character Film		Not printed (round)		A22Z-3460	Print the characters onto the film, and then affix to the plate on the Pushbutton Switch display light. (The back of the film is coated with an adhesive.)
		Printed characters (round)		A22Z-3460-1	
			○	A22Z-3460-2	
			START	A22Z-3460-3	
			STOP	A22Z-3460-4	

Tools

Name	Appearance	Classification	Model	Remarks
Lamp Extractor		---	A22Z-3901	Use this rubber tool to easily mount and remove lamps.
Tightening Tool		---	A22Z-3905	Use to tighten the fastening nuts on the rear of the panel, and to replace the cap on the emergency stop switch (lighted models).

Specifications

■ Ratings

Contacts (Standard Load)

Rated power current (A)	Rated voltage (V)	Rated current (A)			
		Inductive load	Resistive load	Inductive load	Resistive load
10 A	24 VAC	10	10	---	---
	110 VAC	5	10		
	220 VAC	3	6		
	380 VAC	2	3		
	440 VAC	1	2		
	24 VDC	---	---	1.5	10
	110 VDC			0.5	2
	220 VDC			0.2	0.6
380 VDC			0.1	0.2	

Note: 1. The rated current shown was tested at JIS C4520 conditions. The ratings given are for the following test conditions, based on JIS C4505.

Ambient temperature: $20 \pm 2^\circ\text{C}$

Ambient humidity: $65 \pm 5\%$

Operating frequency: 20 operations/min.

2. Minimum applicable load is 10 mA at 5 VDC.

Contacts (Microload)

Ratings	50 mA at 24 VDC (resistive load)
Minimum applicable load	1 mA at 5 VDC

LED Lamp

Rated voltage	Rated current	Power voltage
6 VDC	60 mA (20 mA)	6 VDC $\pm 5\%$
6 VAC	60 mA (20 mA)	6 VDC $\pm 5\%$
12 VAC/VDC	30 mA (10 mA)	12 VAC/VDC $\pm 5\%$
24 VAC/VDC	15 mA (10 mA)	24 VAC/VDC $\pm 5\%$

Note: Ratings in parentheses show rated current for blue LEDs.

Super-bright LED Lamp

Rated voltage	Rated current	Power voltage
24 VAC/VDC	15 mA	24 VAC/VDC $\pm 5\%$

Incandescent Lamp

Rated voltage	Rated current	Power voltage
6 VAC/VDC	200 mA	5 V
14 VAC/VDC	80 mA	12 V
28 VAC/VDC	40 mA	24 V
130 VAC/VDC	20 mA	100 V

Low-voltage Lighting

Rated voltage	Power voltage	Applicable lamp (BA9S/13 metal cap)
110 VAC	100 VAC	LED lamp A22-24A□
220 VAC	200 VAC	

■ Characteristics

		Pushbutton Switch		Knob-type Selector Switch		Key-type Selector Switch
		Non-lighted models A30-F, A30-T, A30-G	Lighted models A30L-T, A30L-G	Non-lighted models A30S	Lighted models A30W	Non-lighted models A30K
Operating frequency	Mechanical	Momentary: 60 operations/minute max.		Manual reset: 30 operations/minute max. Automatic reset: 30 operations/minute max.		
	Electrical	30 operations/minute				
Insulation resistance		100 MΩ min. (at 500 VDC)				
Dielectric strength		2,500 VAC, 50/60 Hz for 1 minute between terminals of same polarity 2,500 VAC, 50/60 Hz for 1 minute between terminals of different polarity, between current-carrying metal parts and ground				
Vibration		Malfunction: 10 to 55 Hz, 1.5 mm double amplitude for 1 ms max.				
Shock	Destruction	1,000 m/s ²	1,000 m/s ²	1,000 m/s ²	1,000 m/s ²	1,000 m/s ²
	Malfunction	1,000 m/s ² max.	600 m/s ² max.	1,000 m/s ² max.	600 m/s ² max.	1,000 m/s ² max.
Life expectancy	Mechanical	Momentary 5,000,000 operations min.		500,000 operations min.	100,000 operations min.	500,000 operations min.
	Electrical	500,000 operations min.		500,000 operations min.	100,000 operations min.	500,000 operations min.
Ambient operating temperature (with no icing or condensation)		-20°C to 70°C	-20°C to 55°C	-20°C to 70°C	-20°C to 55°C	-20°C to 70°C
Ambient operating humidity		35% to 85%				
Ambient storage temperature		-40°C to 70°C				
Degree of protection		IP65 (oil-resistant)	IP65	IP65 (oil-resistant)	IP65	IP65 (oil-resistant)
Electric shock protection class		Class II				
PTI (proof tracking index)		175				
Pollution degree		3 (IEC947-5-1)				

■ Approved Standards Ratings

UL, cUL (File No. E41515)
6 A at 220 VAC, 10 A at 110 VAC

EN60947-5-1 (Low Voltage Directive)
Rated current: 10 A, rated voltage: 220 VAC

■ Operating Characteristics (for SPST-NO + NC Contacts)

Name	Pushbutton Switch	Knob-type Selector Switch		Key-type Selector Switch	
	Lighted/non-lighted Pushbutton Switch	Manual reset	Automatic reset	Manual reset	Automatic reset
	A30-F, A30-T, A30-G, A30L-T, A30L-G	A30S, A30W		A30K	
TTF max.	29.4 N	0.34 N·m (See note.)	2 notches: 0.25 N·m 3 notches: 0.34 N·m (See note.)	0.34 N·m (See note.)	2 notches: 0.25 N·m 3 notches: 0.34 N·m (See note.)
TT	5.5 mm max.	2 notches: Approx 90° (3 notches: Approx 45°)		2 notches: Approx 90° (3 notches: Approx 45°)	
RF	---	0.34 N·m max.	---	0.34 N·m max.	---

Note: Shows the rotational torque value of the Knob-type Selector Switch and the Key-type Selector Switch.

Nomenclature

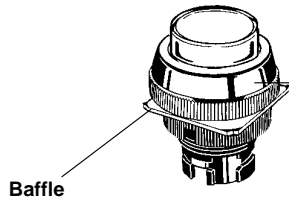

Pushbutton

- **Available Colors**
 Non-lighted models
 Red, Green, Yellow, White, Blue, Black
 Lighted models
 Red, Green, Yellow, White, Blue



Lamp

- **Light source:**
 LED lamp
 Incandescent lamp

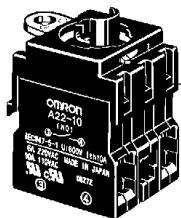

Switch

Contacts

- SPST-NO, SPST-NC, SPST-NO + NC, DPST-NO, DPST-NC
 (Minimum applicable load: 10 mA at 5 VDC)
- **Lighting method**
 Non-lighted
 Lighted (without Voltage Reduction Unit)
 Lighted (with Voltage Reduction Unit)

(The above diagrams show the lighted models.)

Operation

Terminal Arrangement (Bottom View)

Non-lighted models (SPST-NO + NC)	Lighted models (SPST-NO + NC)	Non-lighted models (DPST-NO + NC)

Terminal Connections

Name	Non-lighted models (SPST-NO + NC)	Non-lighted models (DPST-NO + NC)	Lighted models (SPST-NO + NC) without Low Voltage Unit	Lighted models (SPST-NO + NC) with Low Voltage Unit
Terminal connections	Bottom view 	Bottom view 	Bottom view 	Bottom view

■ Panel Cutout

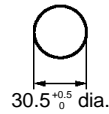

Baffle is fitted as a standard.

When applying a coating such as paint to the panel, dimensions after the coating must satisfy the specified dimensions.

Recommended panel thickness: 1.5 to 5 mm.

Dimensions

Note: All units are in millimeters unless otherwise indicated. For dimension of accessories. Refer to page 188 to 190.

■ Pushbutton Switches (Lighted and Non-lighted Models)

Note: The dimensions given are for the momentary operation switch.

A30-F (Flat)

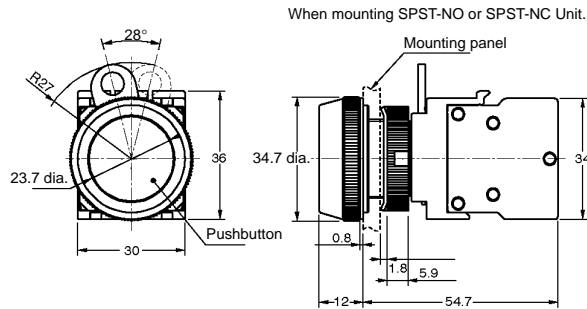
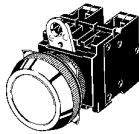

A30-T/A30L-T (Protruding)

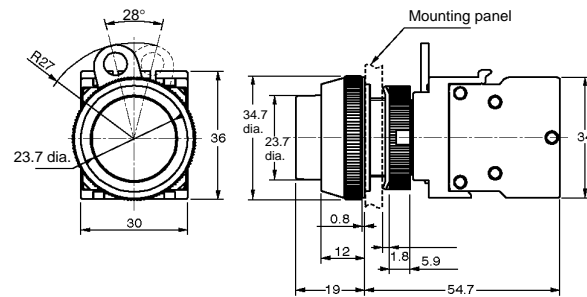
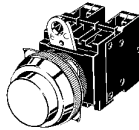

A30-G/A30L-G (Full Guard)

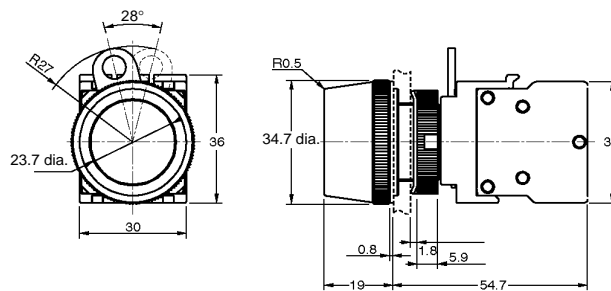
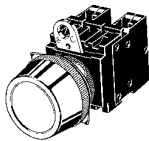

Note: 1. The alternate operation pushbutton is 9.2 mm longer.

2. The lighted Pushbutton Switch has the same dimensions as shown above, both with the Low Voltage Unit and without the Low Voltage Unit.

Precautions

Caution

Do not apply a voltage higher than the maximum rated operating voltage between the incandescent lamp terminals, as there is a risk that the incandescent lamp or LED lamp will be damaged, and the Pushbutton will be ejected.

Refer to the *Common Precautions* for Pushbutton Switches on page 11.

Correct Use

Mounting

Always make sure that the power is turned OFF before mounting, removing, or wiring the Switch, or performing maintenance. Also, do not touch the terminals when power is being supplied, as this may cause electric shock.

Do not tighten the mounting ring more than is necessary using radio pliers or a similar tool, as there is a risk of damage to the mounting ring. Tighten to a torque between 0.98 and 1.96 N·m.

Recommended panel thickness: 1.5 to 5 mm

Wiring

If using a special DC LED, wire the X1 terminal to the + terminal.

For the terminal screws, use M3.5 Phillips or regular screws with built-in square metal washers.

Tighten the terminal screws to a torque of 1.08 to 1.27 N·m.

You can wire solid wires, twisted wires, or crimp terminals.

- Suitable wiring materials:
Twisted wire: 2 mm² max.
Solid wire: Ø1.6 mm max.

Bare Crimp Terminals

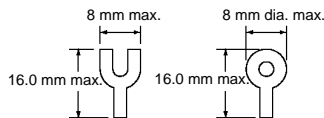

Insulated Covered Crimp Terminals

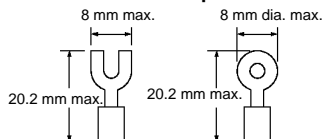

After wiring to the Switch, provide an appropriate insulation distance.

Operating Environment

The structure with the IP65 degree of protection will not be affected by direct water splashing onto the front side of the panel at any angle.

LED

No external resistors are required because the Switch has built-in LED current-limiting resistors.

If using commercial products, select the following: BA9S/13□ metal, total length 26 mm max., 2.6 W max.

Other

When applying a coating such as paint to the panel, dimensions after the coating must satisfy the specified dimensions.

Panel Cutout Dimensions

The panel cutout dimensions are shown below.
Recommended panel thickness is 1.5 to 5 mm.

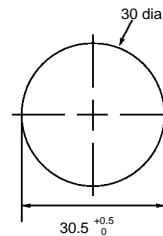

When applying a coating such as paint to the panel, dimensions after the coating must satisfy the specified dimensions.

Matrix Mounting

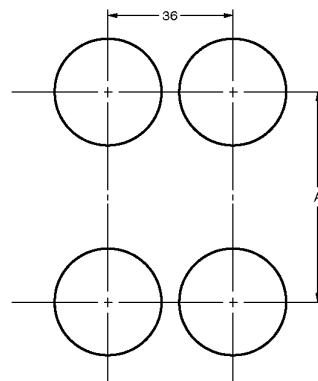

The pitch A, between the centers of the mounting holes, is shown below.

Type of crimp terminal	Switch block	A
Lead wire wired directly	A22-10, A22-10S A22-01, A22-01S	45 mm min.
	A22-20, A22-20S A22-02, A22-02S A22-11, A22-11S	55 mm min.
Bare crimp terminal	A22-10, A22-10S A22-01, A22-01S	51 mm min.
	A22-20, A22-20S A22-02, A22-02S A22-11, A22-11S	61 mm min.
Insulated covered crimp terminal	A22-10, A22-10S A22-01, A22-01S	60 mm min.
	A22-20, A22-20S A22-02, A22-02S A22-11, A22-11S	70 mm min.

- Note:**
1. The dimensions shown above are the minimum dimensions when using wiring materials conforming to the materials given on page 218. If using materials other than those specified, the wiring characteristics will be different, so check the pitch beforehand, and then make the settings.
 2. If using a Pushbutton with external dimensions exceeding 30 mm, set the pitch to suit the Pushbutton's dimensions. (If matrix mounting A22-M□ models, places labelled 36 mm in the matrix mounting diagram become 40 mm.)

ALL DIMENSIONS SHOWN ARE IN MILLIMETERS.

To convert millimeters into inches, multiply by 0.03937. To convert grams into ounces, multiply by 0.03527.

Cat. No. A132-E1-1