

- Easy mounting and removal of Switch Unit.
- Increase wiring efficiency with three-row mounting of Switch Blocks.
- Finger protection mechanism on Switch Unit provided as a standard feature.
- Mounted using either open-type (fork-type) or closed-type (round-type) crimp terminals.
- IP65 oil resistance (non-lighted models)
IP65 (lighted models)
EN60947-5-1



Ordering Information

Model Number Legend

The model numbers used to order sets of Units are illustrated below. One set comprises the Pushbutton, Lamp (lighted models only), and Switch.

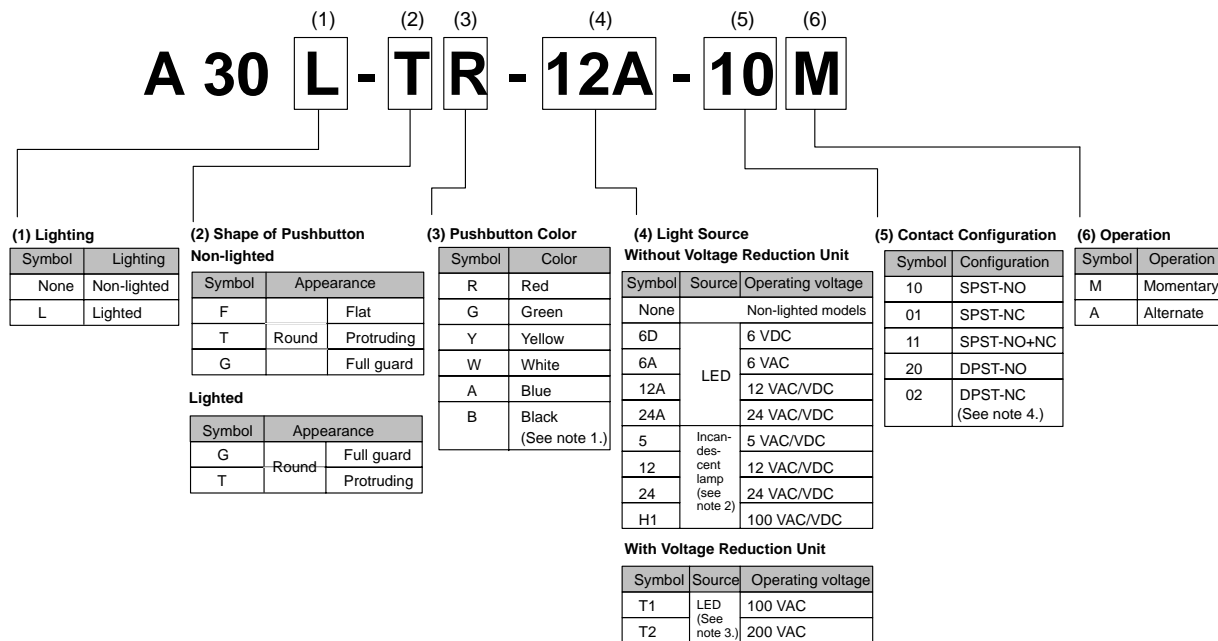

- Note:**
1. Non-lighted models only.
 2. Super-bright LEDs can only be ordered individually.
 3. 24-VAC/VDC LEDs are built-in.
 4. For the contact ratings, refer to page 214.

■ List of Models

Pushbutton Switches (Non-lighted Models)

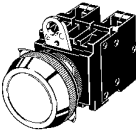
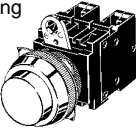
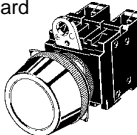
| Model | A30-F | A30-T | A30-G |
|-------|---|--|---|
| Shape | Round | | |
| | Flat  | Protruding  | Full guard  |

Pushbutton Switches (Lighted Models)

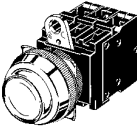
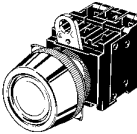
| Model | A30L-T | A30L-G |
|-------|---|---|
| Shape | Round | |
| | Protruding  | Full guard  |

■ Ordering as a Set

Shipped as a set which includes the Pushbutton, Lamp (lighted models only), and Switch.

Non-lighted Models (Round)

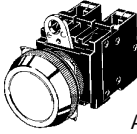
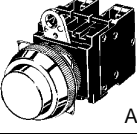
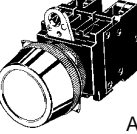
| Appearance | Output | Momentary operation (self-resetting) | Alternate operation (self-holding) | Illumination color |
|---|--------------|---|---------------------------------------|---|
| Flat type  A30-F | SPST-NO | A30-F□-10M | A30-F□-10A | Insert one of the following letters into the box □. R (red) Y (yellow) G (green) W (white) A (blue) B (black) |
| | SPST-NC | A30-F□-01M | A30-F□-01A | |
| | SPST-NO + NC | A30-F□-11M | A30-F□-11A | |
| | DPST-NO | A30-F□-20M | A30-F□-20A | |
| | DPST-NC | A30-F□-02M | A30-F□-02A | |
| Protruding type  A30-T | SPST-NO | A30-T□-10M | A30-T□-10A | |
| | SPST-NC | A30-T□-01M | A30-T□-01A | |
| | SPST-NO + NC | A30-T□-11M | A30-T□-11A | |
| | DPST-NO | A30-T□-20M | A30-T□-20A | |
| | DPST-NC | A30-T□-02M | A30-T□-02A | |
| Full guard type  A30-G | SPST-NO | A30-G□-10M | A30-G□-10A | |
| | SPST-NC | A30-G□-01M | A30-G□-01A | |
| | SPST-NO + NC | A30-G□-11M | A30-G□-11A | |
| | DPST-NO | A30-G□-20M | A30-G□-20A | |
| | SPST-NC | A30-G□-02M | A30-G□-02A | |

Lighted Models (Round)

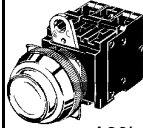
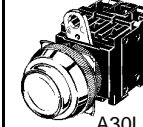
| Appearance | Output | Lighting | Rated voltage | Momentary operation (self-resetting) | Alternate operation (self-holding) | Illumination color |
|--|--------------|----------|----------------|--------------------------------------|------------------------------------|--|
| Protruding models LED-lighting without Voltage Reduction Unit  A30L-T | SPST-NO | LED | 6 VDC | A30L-T□-6D-10M | A30L-T□-6D-10A | Insert one of the following letters into the box □. R (red) Y (yellow) G (green) W (white) A (blue) |
| | | | 6 VAC | A30L-T□-6A-10M | A30L-T□-6A-10A | |
| | | | 12 VDC/VAC | A30L-T□-12A-10M | A30L-T□-12A-10A | |
| | | | 24 VDC/VAC | A30L-T□-24A-10M | A30L-T□-24A-10A | |
| | SPST-NC | | 6 VDC | A30L-T□-6D-01M | A30L-T□-6D-01A | |
| | | | 6 VAC | A30L-T□-6A-01M | A30L-T□-6A-01A | |
| | | | 12 VDC/VAC | A30L-T□-12A-01M | A30L-T□-12A-01A | |
| | | | 24 VDC/VAC | A30L-T□-24A-01M | A30L-T□-24A-01A | |
| | SPST-NO + NC | | 6 VDC | A30L-T□-6D-11M | A30L-T□-6D-11A | |
| | | | 6 VAC | A30L-T□-6A-11M | A30L-T□-6A-11A | |
| | | | 12 VDC/VAC | A30L-T□-12A-11M | A30L-T□-12A-11A | |
| | | | 24 VDC/VAC | A30L-T□-24A-11M | A30L-T□-24A-11A | |
| | DPST-NO | | 6 VDC | A30L-T□-6D-20M | A30L-T□-6D-20A | |
| | | | 6 VAC | A30L-T□-6A-20M | A30L-T□-6A-20A | |
| | | | 12 VDC/VAC | A30L-T□-12A-20M | A30L-T□-12A-20A | |
| | | | 24 VDC/VAC | A30L-T□-24A-20M | A30L-T□-24A-20A | |
| | DPST-NC | | 6 VDC | A30L-T□-6D-02M | A30L-T□-6D-02A | |
| | | | 6 VAC | A30L-T□-6A-02M | A30L-T□-6A-02A | |
| | | | 12 VDC/VAC | A30L-T□-12A-02M | A30L-T□-12A-02A | |
| | | | 24 VDC/VAC | A30L-T□-24A-02M | A30L-T□-24A-02A | |
| Protruding models LED reduced-voltage lighting with Voltage Reduction Unit  A30L-T | SPST-NO | 100 VAC | A30L-T□-T1-10M | A30L-T□-T1-10A | | |
| | | 200 VAC | A30L-T□-T2-10M | A30L-T□-T2-10A | | |
| | SPST-NC | 100 VAC | A30L-T□-T1-01M | A30L-T□-T1-01A | | |
| | | 200 VAC | A30L-T□-T2-01M | A30L-T□-T2-01A | | |
| | SPST-NO + NC | 100 VAC | A30L-T□-T1-11M | A30L-T□-T1-11A | | |
| | | 200 VAC | A30L-T□-T2-11M | A30L-T□-T2-11A | | |
| | DPST-NO | 100 VAC | A30L-T□-T1-20M | A30L-T□-T1-20A | | |
| | | 200 VAC | A30L-T□-T2-20M | A30L-T□-T2-20A | | |
| | DPST-NC | 100 VAC | A30L-T□-T1-02M | A30L-T□-T1-02A | | |
| | | 200 VAC | A30L-T□-T2-02M | A30L-T□-T2-02A | | |

Lighted Models (Round)

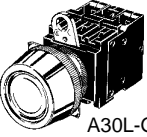
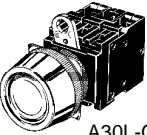
| Appearance | Output | Lighting | Rated voltage | Momentary operation (self-resetting) | Alternate operation (self-holding) | Illumination color |
|--|--------------|-----------------|-----------------|--------------------------------------|------------------------------------|--|
| Full guard models LED-lighting without Voltage Reduction Unit  A30L-G | SPST-NO | LED | 6 VDC | A30L-G□-6D-10M | A30L-G□-6D-10A | Insert one of the following letters into the box □. R (red) Y (yellow) G (green) W (white) A (blue) |
| | | | 6 VAC | A30L-G□-6A-10M | A30L-G□-6A-10A | |
| | | | 12 VDC/VAC | A30L-G□-12A-10M | A30L-G□-12A-10A | |
| | | | 24 VDC/VAC | A30L-G□-24A-10M | A30L-G□-24A-10A | |
| | SPST-NC | | 6 VDC | A30L-G□-6D-01M | A30L-G□-6D-01A | |
| | | | 6 VAC | A30L-G□-6A-01M | A30L-G□-6A-01A | |
| | | | 12 VDC/VAC | A30L-G□-12A-01M | A30L-G□-12A-01A | |
| | | | 24 VDC/VAC | A30L-G□-24A-01M | A30L-G□-24A-01A | |
| | SPST-NO + NC | | 6 VDC | A30L-G□-6D-11M | A30L-G□-6D-11A | |
| | | | 6 VAC | A30L-G□-6A-11M | A30L-G□-6A-11A | |
| | | | 12 VDC/VAC | A30L-G□-12A-11M | A30L-G□-12A-11A | |
| | | | 24 VDC/VAC | A30L-G□-24A-11M | A30L-G□-24A-11A | |
| | DPST-NO | | 6 VDC | A30L-G□-6D-20M | A30L-G□-6D-20A | |
| | | | 6 VAC | A30L-G□-6A-20M | A30L-G□-6A-20A | |
| | | | 12 VDC/VAC | A30L-G□-12A-20M | A30L-G□-12A-20A | |
| | | | 24 VDC/VAC | A30L-G□-24A-20M | A30L-G□-24A-20A | |
| DPST-NC | 6 VDC | A30L-G□-6D-02M | A30L-G□-6D-02A | | | |
| | 6 VAC | A30L-G□-6A-02M | A30L-G□-6A-02A | | | |
| | 12 VDC/VAC | A30L-G□-12A-02M | A30L-G□-12A-02A | | | |
| | 24 VDC/VAC | A30L-G□-24A-02M | A30L-G□-24A-02A | | | |
| Full guard models LED reduced-voltage lighting with Voltage Reduction Unit  A30L-G | SPST-NO | 100 VAC | A30L-G□-T1-10M | A30L-G□-T1-10A | | |
| | SPST-NC | 200 VAC | A30L-G□-T2-10M | A30L-G□-T2-10A | | |
| | | 100 VAC | A30L-G□-T1-01M | A30L-G□-T1-01A | | |
| | SPST-NO + NC | 200 VAC | A30L-G□-T2-01M | A30L-G□-T2-01A | | |
| | | 100 VAC | A30L-G□-T1-11M | A30L-G□-T1-11A | | |
| | DPST-NO | 200 VAC | A30L-G□-T2-11M | A30L-G□-T2-11A | | |
| | | 100 VAC | A30L-G□-T1-20M | A30L-G□-T1-20A | | |
| | DPST-NC | 200 VAC | A30L-G□-T2-20M | A30L-G□-T2-20A | | |
| | | 100 VAC | A30L-G□-T1-02M | A30L-G□-T1-02A | | |
| | | | 200 VAC | A30L-G□-T2-02M | A30L-G□-T2-02A | |

■ Ordering Individually

Pushbuttons, Lamps, and Switches can be ordered separately. Combinations that are not available as sets can be created using individual Units. Also, store the parts as spares for maintenance and repairs.

Non-lighted Models

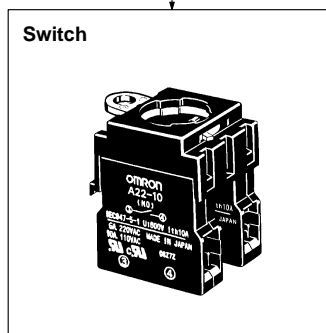
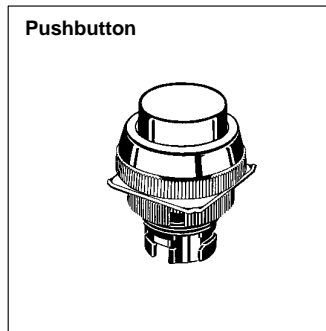

Lighted Models without Voltage Reduction Unit

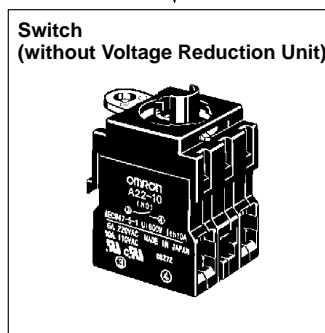
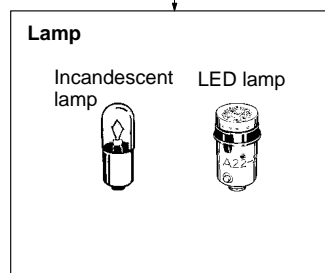
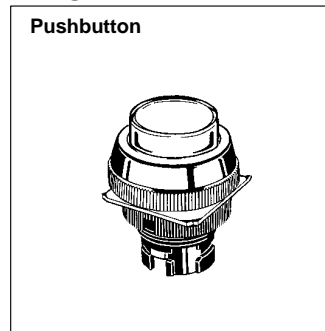

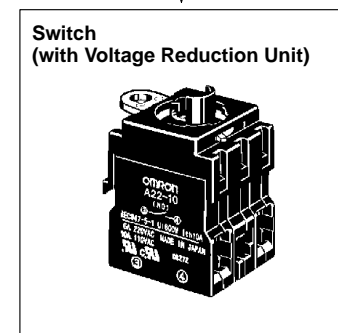
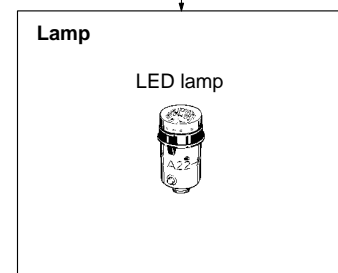
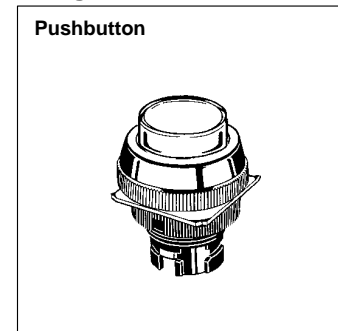

Lighted Models with Voltage Reduction Unit



■ Pushbutton Switches (Subassembly)

Pushbutton

Non-lighted Models

| Sealant | IP65 oil-resistant models | | |
|------------------|---|--|---|
| | Flat | Protruding | Full guard |
| Appearance |  |  |  |
| Pushbutton color | | | |
| Red | A30-FR | A30-TR | A30-GR |
| Green | A30-FG | A30-TG | A30-GG |
| Yellow | A30-FY | A30-TY | A30-GY |
| White | A30-FW | A30-TW | A30-GW |
| Blue | A30-FA | A30-TA | A30-GA |
| Black | A30-FB | A30-TB | A30-GB |

Lighted Models

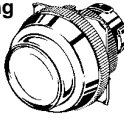
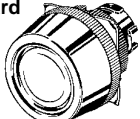
| Sealant | IP65 | |
|------------------|---|--|
| | Protruding | Full guard |
| Appearance |  |  |
| Pushbutton color | | |
| Red | A30L-TR | A30L-GR |
| Green | A30L-TG | A30L-GG |
| Yellow | A30L-TY | A30L-GY |
| White | A30L-TW | A30L-GW |
| Blue | A30L-TA | A30L-GA |

Note: Common to incandescent lamps and LED lamps.

Lamp

LED Lamps

| Appearance | Rated voltage | Color | 6 V | 12 V | 24 V | Super-bright 24 V |
|---|---------------|----------------------|---------|----------|----------|----------------------|
| | | | | | | |
|  | DC | Red | A22-6DR | --- | --- | --- |
| | | Green | A22-6DG | --- | --- | --- |
| | | Yellow (See note 2.) | A22-6DY | --- | --- | --- |
| | | Blue | A22-6DA | --- | --- | --- |
| | AC | Red | A22-6AR | --- | --- | --- |
| | | Green | A22-6AG | --- | --- | --- |
| | | Yellow (See note 2.) | A22-6AY | --- | --- | --- |
| | | Blue | A22-6AA | --- | --- | --- |
| | AC/DC | Red | --- | A22-12AR | A22-24AR | A22-24ASR |
| | | Green | --- | A22-12AG | A22-24AG | A22-24ASG |
| | | Yellow (See note 2.) | --- | A22-12AY | A22-24AY | A22-24ASY |
| | | Blue | --- | A22-12AA | A22-24AA | A22-24ASA |

Note: 1. If using low-voltage lighting, select A22-24A□ models.

2. Select if the Pushbutton is yellow or white.

Incandescent Lamp

| Rated voltage | 6 VDC/VAC | 14 VDC/VAC | 28 VDC/VAC | 130 VDC/VAC |
|---|-----------|------------|------------|-------------|
| Appearance | | | | |
|  | A22-5 | A22-12 | A22-24 | A22-H1 |

Switch (Standard Load)

Without Low Voltage Unit





| | Classification | Non-lighted | | Lighted | |
|-----------------------|----------------|-------------|-----------|------------|-----------|
| | | Appearance | | Appearance | |
| | | Operation | | Operation | |
| Contact configuration | | Momentary | Alternate | Momentary | Alternate |
| Standard load | SPST-NO | A22-10M | A22-10A | A22L-10M | A22L-10A |
| | SPST-NC | A22-01M | A22-01A | A22L-01M | A22L-01A |
| | SPST-NO + NC | A22-11M | A22-11A | A22L-11M | A22L-11A |
| | DPST-NO | A22-20M | A22-20A | A22L-20M | A22L-20A |
| | DPST-NC | A22-02M | A22-02A | A22L-02M | A22L-02A |

With Low Voltage Unit

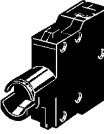
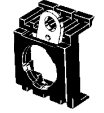

| | Classification | Lighted 110 VAC | | Lighted 220 VAC | |
|-----------------------|----------------|-----------------|-------------|-----------------|-------------|
| | | Appearance | | Appearance | |
| | | Operation | | Operation | |
| Contact configuration | | Momentary | Alternate | Momentary | Alternate |
| Standard load | SPST-NO | A22L-10M-T1 | A22L-10A-T1 | A22L-10M-T2 | A22L-10A-T2 |
| | SPST-NC | A22L-01M-T1 | A22L-01A-T1 | A22L-01M-T2 | A22L-01A-T2 |
| | SPST-NO + NC | A22L-11M-T1 | A22L-11A-T1 | A22L-11M-T2 | A22L-11A-T2 |
| | DPST-NO | A22L-20M-T1 | A22L-20A-T1 | A22L-20M-T2 | A22L-20A-T2 |
| | DPST-NC | A22L-02M-T1 | A22L-02A-T1 | A22L-02M-T2 | A22L-02A-T2 |

Note: The diagrams show a typical DPST-NO configuration. If using a Low Voltage Unit, select A22-24A□ models.

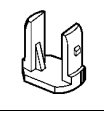
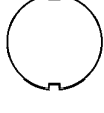
■ Accessories (Order Separately)

| Name | Appearance | Classification | | Model | Remarks |
|----------------|---|----------------------------|---------------|-------------|--|
| Switch Blocks |  | SPST-NO | Standard load | A22-10 | Equipped as standard. Use when adding or replacing Switch Blocks. |
| | | | Microload | A22-10S | |
| | | SPST-NC | Standard load | A22-01 | |
| | | | Microload | A22-01S | |
| |  | DPST-NO | Standard load | A22-20 | |
| | | | Microload | A22-20S | |
| | | DPST-NC | Standard load | A22-02 | |
| | | | Microload | A22-02S | |
| DPST-NO + NC | | Standard load | A22-11 | | |
| | | Microload | A22-11S | | |
| Lamp Socket |  | Direct lighting | | A22-TN | Use to change lighting method. |
| | | Low-voltage lighting | 100 VAC | A22-T1 | |
| | | | 200 VAC | A22-T2 | |
| Mounting Board |  | Momentary operation | | A22-3200 | Use when purchasing and mounting individual Switch Blocks and lighting units. |
| | | Alternate operation | | A22-3210 | |
| Colored Cap |  | Red | | A22Z-30TR | Use to change the color of the Pushbutton of (round) lighted Pushbutton Switches. |
| | | Green | | A22Z-30TG | |
| | | Yellow | | A22Z-30TY | |
| | | White | | A22Z-30TW | |
| | | Blue | | A22Z-30TA | |
| 3-unit Spacer |  | --- | | A22Z-3003 | Use to mount 3 Switch Blocks on a non-lighted Pushbutton Switch. You cannot use emergency stop, Knob-type Selector Switch, or Key-type Selector Switches. Refer to page 220 for details. |
| Character Film |  | Not printed (round) | | A22Z-3460 | Print the characters onto the film, and then affix to the plate on the Pushbutton Switch display light. (The back of the film is coated with an adhesive.) |
| | | Printed characters (round) | | A22Z-3460-1 | |
| | | | ○ | A22Z-3460-2 | |
| | | | START | A22Z-3460-3 | |
| | | | STOP | A22Z-3460-4 | |

Tools

| Name | Appearance | Classification | Model | Remarks |
|-----------------|---|----------------|-----------|---|
| Lamp Extractor |  | --- | A22Z-3901 | Use this rubber tool to easily mount and remove lamps. |
| Tightening Tool |  | --- | A22Z-3905 | Use to tighten the fastening nuts on the rear of the panel, and to replace the cap on the emergency stop switch (lighted models). |

Specifications

■ Ratings

Contacts (Standard Load)

| Rated power current (A) | Rated voltage (V) | Rated current (A) | | | |
|-------------------------|-------------------|-------------------|----------------|----------------|----------------|
| | | Inductive load | Resistive load | Inductive load | Resistive load |
| 10 A | 24 VAC | 10 | 10 | --- | --- |
| | 110 VAC | 5 | 10 | | |
| | 220 VAC | 3 | 6 | | |
| | 380 VAC | 2 | 3 | | |
| | 440 VAC | 1 | 2 | | |
| | 24 VDC | --- | --- | 1.5 | 10 |
| | 110 VDC | | | 0.5 | 2 |
| | 220 VDC | | | 0.2 | 0.6 |
| 380 VDC | | | 0.1 | 0.2 | |

Note: 1. The rated current shown was tested at JIS C4520 conditions. The ratings given are for the following test conditions, based on JIS C4505.

Ambient temperature: $20 \pm 2^\circ\text{C}$

Ambient humidity: $65 \pm 5\%$

Operating frequency: 20 operations/min.

2. Minimum applicable load is 10 mA at 5 VDC.

Contacts (Microload)

| | |
|--------------------------------|----------------------------------|
| Ratings | 50 mA at 24 VDC (resistive load) |
| Minimum applicable load | 1 mA at 5 VDC |

LED Lamp

| Rated voltage | Rated current | Power voltage |
|---------------|---------------|----------------------|
| 6 VDC | 60 mA (20 mA) | 6 VDC $\pm 5\%$ |
| 6 VAC | 60 mA (20 mA) | 6 VDC $\pm 5\%$ |
| 12 VAC/VDC | 30 mA (10 mA) | 12 VAC/VDC $\pm 5\%$ |
| 24 VAC/VDC | 15 mA (10 mA) | 24 VAC/VDC $\pm 5\%$ |

Note: Ratings in parentheses show rated current for blue LEDs.

Super-bright LED Lamp

| Rated voltage | Rated current | Power voltage |
|---------------|---------------|----------------------|
| 24 VAC/VDC | 15 mA | 24 VAC/VDC $\pm 5\%$ |

Incandescent Lamp

| Rated voltage | Rated current | Power voltage |
|---------------|---------------|---------------|
| 6 VAC/VDC | 200 mA | 5 V |
| 14 VAC/VDC | 80 mA | 12 V |
| 28 VAC/VDC | 40 mA | 24 V |
| 130 VAC/VDC | 20 mA | 100 V |

Low-voltage Lighting

| Rated voltage | Power voltage | Applicable lamp (BA9S/13 metal cap) |
|---------------|---------------|-------------------------------------|
| 110 VAC | 100 VAC | LED lamp |
| 220 VAC | 200 VAC | A22-24A□ |

■ Characteristics

| | | Pushbutton Switch | | Knob-type Selector Switch | | Key-type Selector Switch |
|---|-------------|--|----------------------------------|---|---------------------------|-----------------------------|
| | | Non-lighted models A30-F, A30-T, A30-G | Lighted models A30L-T, A30L-G | Non-lighted models A30S | Lighted models A30W | Non-lighted models A30K |
| Operating frequency | Mechanical | Momentary: 60 operations/minute max. | | Manual reset: 30 operations/minute max. Automatic reset: 30 operations/minute max. | | |
| | Electrical | 30 operations/minute | | | | |
| Insulation resistance | | 100 MΩ min. (at 500 VDC) | | | | |
| Dielectric strength | | 2,500 VAC, 50/60 Hz for 1 minute between terminals of same polarity 2,500 VAC, 50/60 Hz for 1 minute between terminals of different polarity, between current-carrying metal parts and ground | | | | |
| Vibration | | Malfunction: 10 to 55 Hz, 1.5 mm double amplitude for 1 ms max. | | | | |
| Shock | Destruction | 1,000 m/s ² | 1,000 m/s ² | 1,000 m/s ² | 1,000 m/s ² | 1,000 m/s ² |
| | Malfunction | 1,000 m/s ² max. | 600 m/s ² max. | 1,000 m/s ² max. | 600 m/s ² max. | 1,000 m/s ² max. |
| Life expectancy | Mechanical | Momentary 5,000,000 operations min. | | 500,000 operations min. | 100,000 operations min. | 500,000 operations min. |
| | Electrical | 500,000 operations min. | | 500,000 operations min. | 100,000 operations min. | 500,000 operations min. |
| Ambient operating temperature (with no icing or condensation) | | -20°C to 70°C | -20°C to 55°C | -20°C to 70°C | -20°C to 55°C | -20°C to 70°C |
| Ambient operating humidity | | 35% to 85% | | | | |
| Ambient storage temperature | | -40°C to 70°C | | | | |
| Degree of protection | | IP65 (oil-resistant) | IP65 | IP65 (oil-resistant) | IP65 | IP65 (oil-resistant) |
| Electric shock protection class | | Class II | | | | |
| PTI (proof tracking index) | | 175 | | | | |
| Pollution degree | | 3 (IEC947-5-1) | | | | |

■ Approved Standards Ratings

UL, cUL (File No. E41515)
6 A at 220 VAC, 10 A at 110 VAC

EN60947-5-1 (Low Voltage Directive)
Rated current: 10 A, rated voltage: 220 VAC

■ Operating Characteristics (for SPST-NO + NC Contacts)

| Name | Pushbutton Switch | Knob-type Selector Switch | | Key-type Selector Switch | |
|----------|---------------------------------------|---|--|---|--|
| | Lighted/non-lighted Pushbutton Switch | Manual reset | Automatic reset | Manual reset | Automatic reset |
| | A30-F, A30-T, A30-G, A30L-T, A30L-G | A30S, A30W | | A30K | |
| TTF max. | 29.4 N | 0.34 N·m (See note.) | 2 notches: 0.25 N·m 3 notches: 0.34 N·m (See note.) | 0.34 N·m (See note.) | 2 notches: 0.25 N·m 3 notches: 0.34 N·m (See note.) |
| TT | 5.5 mm max. | 2 notches: Approx 90° (3 notches: Approx 45°) | | 2 notches: Approx 90° (3 notches: Approx 45°) | |
| RF | --- | 0.34 N·m max. | --- | 0.34 N·m max. | --- |

Note: Shows the rotational torque value of the Knob-type Selector Switch and the Key-type Selector Switch.

Nomenclature

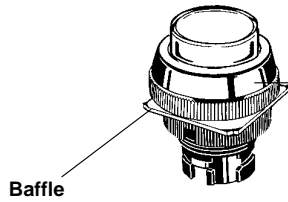

Pushbutton

- **Available Colors**
 Non-lighted models
 Red, Green, Yellow, White, Blue, Black
 Lighted models
 Red, Green, Yellow, White, Blue



Lamp

- **Light source:**
 LED lamp
 Incandescent lamp

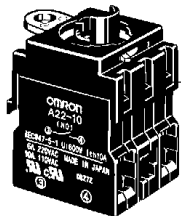

Switch

Contacts

- SPST-NO, SPST-NC, SPST-NO + NC, DPST-NO, DPST-NC
 (Minimum applicable load: 10 mA at 5 VDC)
- **Lighting method**
 Non-lighted
 Lighted (without Voltage Reduction Unit)
 Lighted (with Voltage Reduction Unit)

(The above diagrams show the lighted models.)

Operation

Terminal Arrangement (Bottom View)

| Non-lighted models (SPST-NO + NC) | Lighted models (SPST-NO + NC) | Non-lighted models (DPST-NO + NC) |
|-----------------------------------|-------------------------------|-----------------------------------|
| | | |

Terminal Connections

| Name | Non-lighted models (SPST-NO + NC) | Non-lighted models (DPST-NO + NC) | Lighted models (SPST-NO + NC) without Low Voltage Unit | Lighted models (SPST-NO + NC) with Low Voltage Unit |
|----------------------|-----------------------------------|-----------------------------------|--|---|
| Terminal connections | Bottom view | Bottom view | Bottom view | Bottom view |

■ Panel Cutout

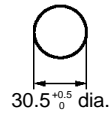

Baffle is fitted as a standard.

When applying a coating such as paint to the panel, dimensions after the coating must satisfy the specified dimensions.

Recommended panel thickness: 1.5 to 5 mm.

Dimensions

Note: All units are in millimeters unless otherwise indicated. For dimension of accessories. Refer to page 188 to 190.

■ Pushbutton Switches (Lighted and Non-lighted Models)

Note: The dimensions given are for the momentary operation switch.

A30-F (Flat)

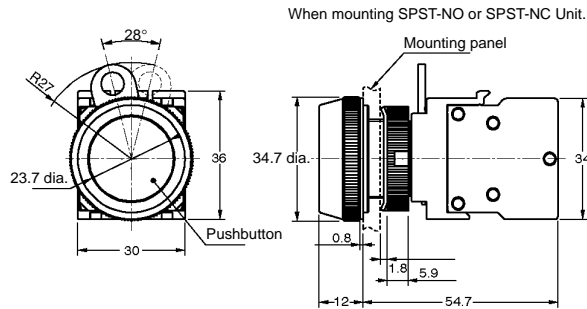
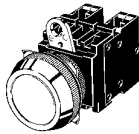

A30-T/A30L-T (Protruding)

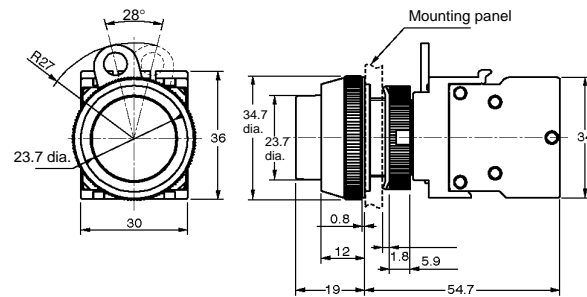
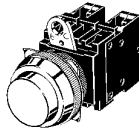

A30-G/A30L-G (Full Guard)

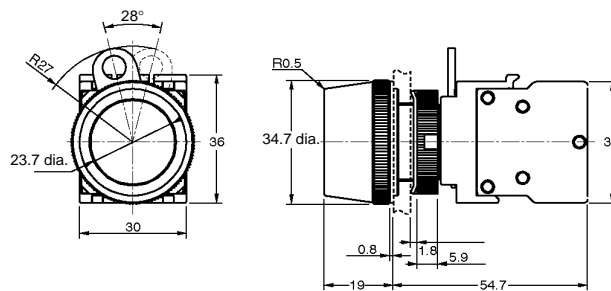
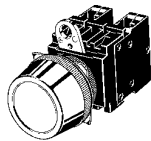

Note: 1. The alternate operation pushbutton is 9.2 mm longer.

2. The lighted Pushbutton Switch has the same dimensions as shown above, both with the Low Voltage Unit and without the Low Voltage Unit.

Precautions

Caution

Do not apply a voltage higher than the maximum rated operating voltage between the incandescent lamp terminals, as there is a risk that the incandescent lamp or LED lamp will be damaged, and the Pushbutton will be ejected.

Refer to the *Common Precautions* for Pushbutton Switches on page 11.

Correct Use

Mounting

Always make sure that the power is turned OFF before mounting, removing, or wiring the Switch, or performing maintenance. Also, do not touch the terminals when power is being supplied, as this may cause electric shock.

Do not tighten the mounting ring more than is necessary using radio pliers or a similar tool, as there is a risk of damage to the mounting ring. Tighten to a torque between 0.98 and 1.96 N·m.

Recommended panel thickness: 1.5 to 5 mm

Wiring

If using a special DC LED, wire the X1 terminal to the + terminal.

For the terminal screws, use M3.5 Phillips or regular screws with built-in square metal washers.

Tighten the terminal screws to a torque of 1.08 to 1.27 N·m.

You can wire solid wires, twisted wires, or crimp terminals.

- Suitable wiring materials:
Twisted wire: 2 mm² max.
Solid wire: Ø1.6 mm max.

Bare Crimp Terminals

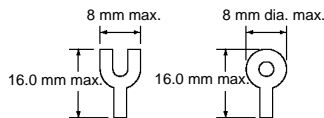

Insulated Covered Crimp Terminals

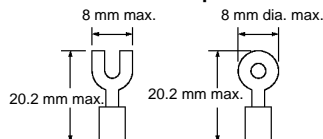

After wiring to the Switch, provide an appropriate insulation distance.

Operating Environment

The structure with the IP65 degree of protection will not be affected by direct water splashing onto the front side of the panel at any angle.

LED

No external resistors are required because the Switch has built-in LED current-limiting resistors.

If using commercial products, select the following: BA9S/13□ metal, total length 26 mm max., 2.6 W max.

Other

When applying a coating such as paint to the panel, dimensions after the coating must satisfy the specified dimensions.

Panel Cutout Dimensions

The panel cutout dimensions are shown below.
Recommended panel thickness is 1.5 to 5 mm.

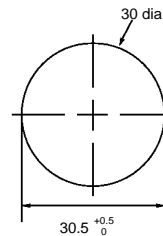

When applying a coating such as paint to the panel, dimensions after the coating must satisfy the specified dimensions.

Matrix Mounting

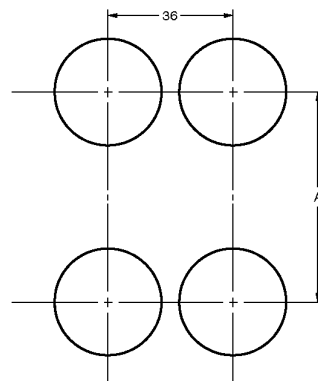

The pitch A, between the centers of the mounting holes, is shown below.

| Type of crimp terminal | Switch block | A |
|----------------------------------|---|------------|
| Lead wire wired directly | A22-10, A22-10S A22-01, A22-01S | 45 mm min. |
| | A22-20, A22-20S A22-02, A22-02S A22-11, A22-11S | 55 mm min. |
| | | |
| Bare crimp terminal | A22-10, A22-10S A22-01, A22-01S | 51 mm min. |
| | A22-20, A22-20S A22-02, A22-02S A22-11, A22-11S | 61 mm min. |
| | | |
| Insulated covered crimp terminal | A22-10, A22-10S A22-01, A22-01S | 60 mm min. |
| | A22-20, A22-20S A22-02, A22-02S A22-11, A22-11S | 70 mm min. |

- Note:**
1. The dimensions shown above are the minimum dimensions when using wiring materials conforming to the materials given on page 218. If using materials other than those specified, the wiring characteristics will be different, so check the pitch beforehand, and then make the settings.
 2. If using a Pushbutton with external dimensions exceeding 30 mm, set the pitch to suit the Pushbutton's dimensions. (If matrix mounting A22-M□ models, places labelled 36 mm in the matrix mounting diagram become 40 mm.)

ALL DIMENSIONS SHOWN ARE IN MILLIMETERS.

To convert millimeters into inches, multiply by 0.03937. To convert grams into ounces, multiply by 0.03527.

Cat. No. A132-E1-1