

C&K E Series Sealed Miniature Rocker and Lever Handle Switches

Features/Benefits

- Sealed against solder and cleaning process contaminants
- ESD Resistance—all actuator options
- Rocker, case & bushing UL 94V-0

Typical Applications

- Telecommunications
- Instrumentation
- Computers & peripherals

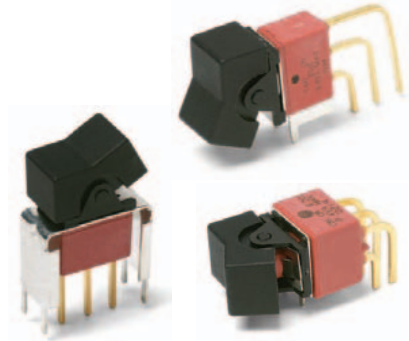

Specifications

CONTACT RATING: B contact material: 0.4 VA max. @ 20 V AC or DC max. Q contact material (E1XX & E2XX Models): 7.5 AMPS @125 V AC or 28 V DC; 3 AMPS @ 250 V AC. (E3XX Models): 5 AMPS @ 125 V AC or 28 V DC; 2 AMPS @ 250 V AC. See page G-36 for additional ratings.

ELECTRICAL LIFE: E1XX and E2XX models: 40,000 make-and-break cycles at full load. E3XX models: 30,000 cycles.

CONTACT RESISTANCE: Below 10 m Ω typ. initial @ 2-4 V DC, 100 mA, for both silver and gold plated contacts.

INSULATION RESISTANCE: 10⁹ Ω min.

ELECTROSTATIC DISCHARGE (ESD) OPTION: All actuator options: 15,000 V DC max. @ sea level, actuator to terminals.

DIELECTRIC STRENGTH: 1000 Vrms min. @ sea level.

OPERATING TEMPERATURE: -30°C to 85°C.

SOLDERABILITY: Per MIL-STD-202F method 208D, or EIA RS-186E method 9 (1 hour steam aging).

Materials

CASE & BUSHING: Glass filled nylon 6/6, flame retardant, heat stabilized (UL 94V-0).

ACTUATOR: Nylon, black standard, internal o-ring seal standard with all actuators.

FRAME: Spring steel, black standard.

SWITCH SUPPORT: Brass or steel, tin plated.

ACTUATOR PIVOT & MOUNTING BRACKET: Nylon.

ACTUATOR PIVOT RETAINER: Stainless steel.

CONTACTS & TERMINALS: B contact material: Copper alloy, with gold plate over nickel plate. Q contact material: Copper alloy, silver plated. See page G-36 for additional contact materials.

TERMINAL SEAL: Epoxy.

HARDWARE: Nut, Screw & Lockwasher: Stainless steel. Standoff: Nylon standard, aluminum available, consult Customer Service Center.

NOTE: Specifications and materials listed above are for switches with standard options. For information on specific and custom switches, consult Customer Service Center.

Build-A-Switch

To order, simply select desired option from each category and place in the appropriate box. Available options are shown and described on pages G-26 thru G-36. For additional options not shown in catalog, consult Customer Service Center. All models are process sealed to withstand machine soldering temperatures and pressure wash cleaning methods.

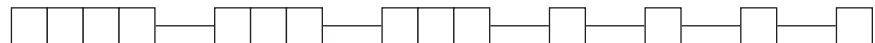

Switch Function

- E101 (STD.) SP On-None-On
- E103 SP On-Off-On
- E105 SP Mom.-Off-Mom.
- E107 SP On-Off-Mom.
- E108 SP On-None-Mom.
- E201 (STD.) DP On-None-On
- E203 DP On-Off-On
- E205 DP Mom.-Off-Mom.
- E207 DP On-Off-Mom.
- E208 DP On-None-Mom.
- E211 DP On-On-On
- E213 DP On-On-Mom.
- E215 DP Mom.-On-Mom.
- E301 (STD.) 3P On-None-On

Actuator

- J1 (STD.) .531 long rocker
- J2 Lever
- J3 .906" long rocker
- J8 Rocker
- J11 Rocker with frame
- J21 Lever with frame
- J50 .362" long rocker
- J60 Lever
- J90 Lever

Terminations

- A (STD.) Right angle, PC thru-hole
- AV2 (STD.) Vertical right angle, PC thru-hole
- C (STD.) PC Thru-hole
- Z (STD.) Solder lug
- A3 Right angle, snap-in, PC thru-hole
- AV3 Vertical right angle, snap-in, PC thru-hole
- AW3 Right angle, extended, PC thru-hole
- V2 .555" high, V-bracket
- V3 .460" high, V-bracket
- V4 .630" high, V-bracket
- V5 Vertical right angle, PC thru-hole
- V6 .460" high, V-bracket
- V7 .630" high, V-bracket
- V8 .953" high, V-bracket
- V9 1.150" high, V-bracket
- V21 .555" high, V-bracket, snap-in
- V31 .460" high, V-bracket, snap-in
- V41 .630" high, V-bracket, snap-in
- V61 .460" high, V-bracket, snap-in
- W .750" long, wire wrap

Contact Material

- B (STD.) Gold
- Q (STD.) Silver
- K Gold, tin-lead
- M Silver, tin-lead
- G Gold over silver
- L Gold over silver, tin lead

Seal

- E (STD.) Epoxy

Actuator Color

- 2 (STD.) Black
- 1 White
- 3 Red

Frame Color

- 2 (STD.) Black
- NONE No frame color required
- 1 White

Metal Frame Color (J11, J21 Actuators)

- 2 (STD.) Black
- 1 White

Rocker



C&K E Series Sealed Miniature Rocker and Lever Handle Switches

SWITCH FUNCTION

NO. POLES	MODEL NO.	SWITCH FUNCTION			CONNECTED TERMINALS			SCHEMATIC
		POS. 1	POS. 2	POS. 3	POS. 1	POS. 2	POS. 3	
		C&K marking on opposite side			C&K marking on opposite side			
SP	E101 (STD.)	ON	NONE	ON	2-3	N/A	2-1	
	E103	ON	OFF	ON		OPEN		
	E105	MOM.	OFF	MOM.				
	E107	ON	OFF	MOM.				
	E108	ON	NONE	MOM.		N/A		
SPDT								
		Part number shown: E101J1ZBE2						
DP	E201 (STD.)	ON	NONE	ON	2-3,5-6	N/A	2-1,5-4	
	E203	ON	OFF	ON		OPEN		
	E205	MOM.	OFF	MOM.				
	E207	ON	OFF	MOM.				
	E208	ON	NONE	MOM.				
	E211**	ON	ON	ON				
	E213**	ON	ON	MOM.				
	E215**	MOM.	ON	MOM.				
DPDT								
		Part number shown: E201J1ZBE2						

MOM. = Momentary

All models with all options when ordered with G, L, M or Q contact material.

** Wiring for 3-way switch, see Section N.

Rocker



G



Third Angle Projection
Dimensions are shown: IN (mm)
Dimensions subject to change



Cannon

G-27

www.ittcannon.com

C&K E Series Sealed Miniature Rocker and Lever Handle Switches

SWITCH FUNCTION

NO. POLES	MODEL NO.	SWITCH FUNCTION			CONNECTED TERMINALS			SCHEMATIC
		POS. 1	POS. 2	POS. 3	POS. 1	POS. 2	POS. 3	
		C&K marking on opposite side			C&K marking on opposite side			
3P	E301 (STD.)	ON	NONE	ON	2-3,5-6,8-9	N/A	2-1,5-4,8-7	
3PDT <p>Part number shown: E301J1ZBE2</p>								

MOM. = Momentary

All models with all options when ordered with G, L, M or Q contact material.

** Wiring for 3-way switch, see Section N.

ACTUATOR-PANEL REAR MOUNT

OPTION CODE	ACTUATOR COLOR
2	(STD.) BLACK
1	WHITE
3	RED

Finish: Matte. Other colors, custom actuator markings and legends available, consult Customer Service Center.

NOTE: Hardware: two each—mounting screws, nuts, lockwashers and standoffs for 1/8 inch thick panel are supplied standard on switches with panel mounting bracket. Internal o-ring actuator seal standard. Actuators available separately, see page G-37. Hardware available separately, see section N. J1, J2 actuators available with C, Z or Z3 terminations.

PANEL MOUNTING

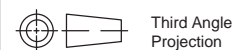
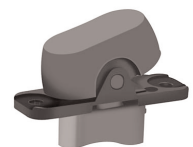
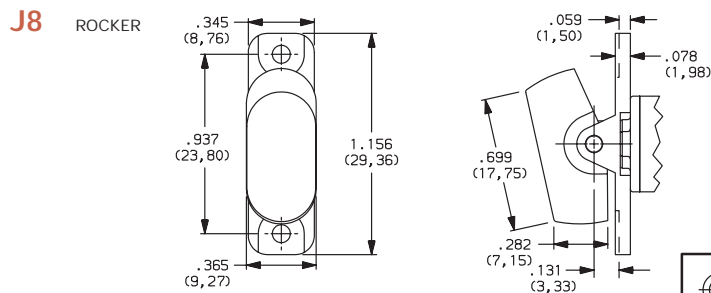
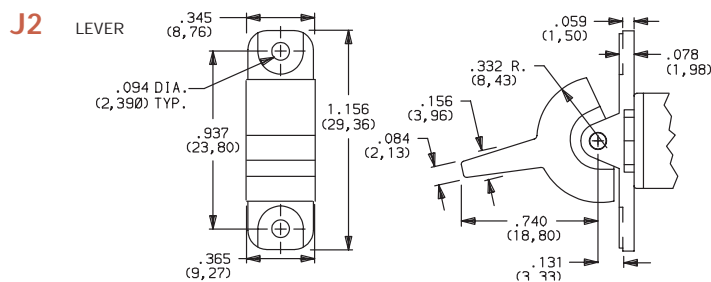
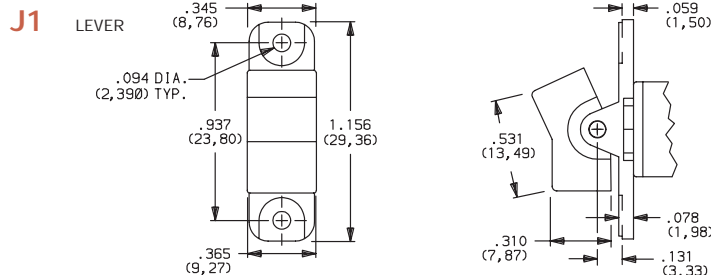
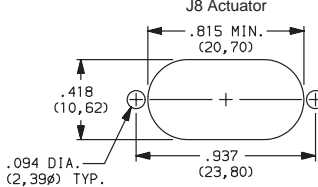
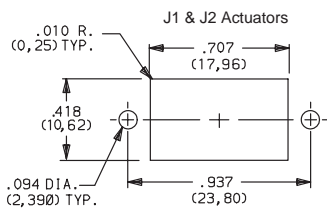

Dimensions are shown: IN (mm)
Dimensions subject to change

Rocker



C&K E Series Sealed Miniature Rocker and Lever Handle Switches

ACTUATOR-REAR MOUNT

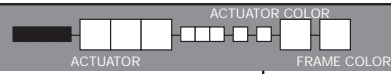

J11 ROCKER WITH FRAME

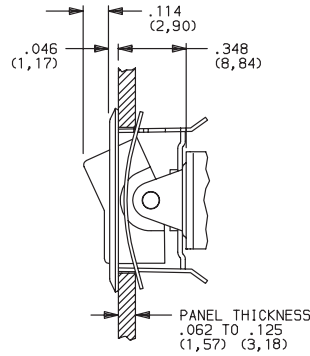
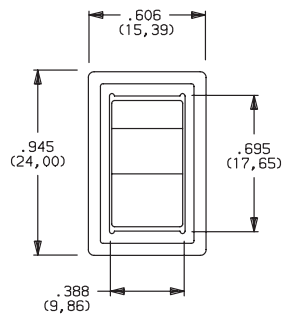

OPTION CODE	ACTUATOR COLOR
2	(STD.) BLACK
1	WHITE
3	RED

OPTION CODE	FRAME COLOR
2	(STD.) BLACK
1	WHITE

NOTE: This option has reduced anti-static capability.

J21 LEVER WITH FRAME

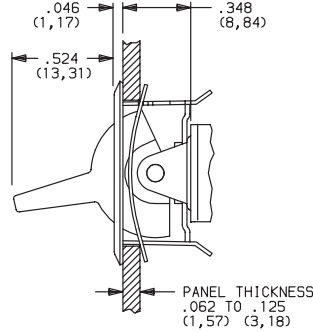
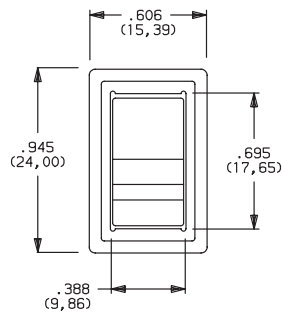

Actuator finish: Matte, frame finish: gloss. Other colors, custom actuator markings and legends available, consult Customer Service Center.

NOTE: Internal o-ring actuator seal standard. Actuators & frames available separately, see page G-37. Hardware available separately, see section N. J11 & J21 actuators available with C, Z & Z3 terminations.

PANEL MOUNTING

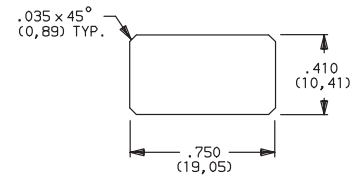

NOTE: This option has reduced anti-static capability.

ACTUATOR-PC MOUNT

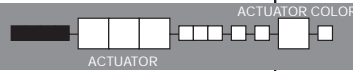

J1 ROCKER

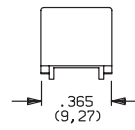
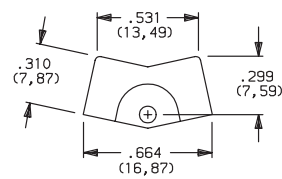

OPTION CODE	ACTUATOR COLOR
2	(STD.) BLACK
1	WHITE
3	RED

J2 LEVER

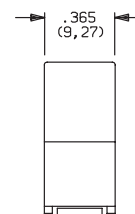
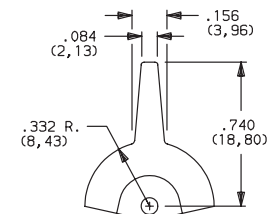

Finish: Matte. Other colors, custom actuator markings and legends available, consult Customer Service Center.

NOTE: Hardware: two each—mounting screws, nuts, lockwashers and standoffs for 1/8 inch thick panel are supplied standard on switches with panel mounting bracket. Internal o-ring actuator seal standard. Actuators available separately, see page G-37. Hardware available separately, see section N. J1, J2 actuators available with A, A3, AV2, AV3, V2-V61 terminations.

Rocker



G



Dimensions are shown: IN (mm)
Dimensions subject to change

C&K E Series Sealed Miniature Rocker and Lever Handle Switches

ACTUATOR-PC MOUNT

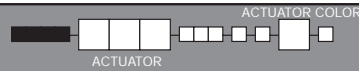

OPTION CODE	ACTUATOR COLOR
2	(STD.) BLACK
1	WHITE
3	RED

Finish: Matte. Other colors, custom actuator markings and legends available, consult Customer Service Center.

NOTE: Hardware: two each—mounting screws, nuts, lockwashers and standoffs for 1/8 inch thick panel are supplied standard on switches with panel mounting bracket. Internal o-ring actuator seal standard. Actuators available separately, see page G-37. Hardware available separately, see section N.

J3 actuators available with AV2, AV3 & V2-V61 terminations. Some permissible actuator/termination combinations may lack clearance between actuator and PC board, and care must be exercised to accommodate this condition.

J50, J60 & J90 actuators available with A, AV2, AV3 terminations.

J3 ROCKER

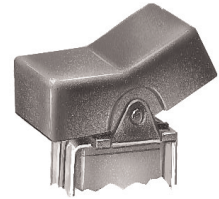
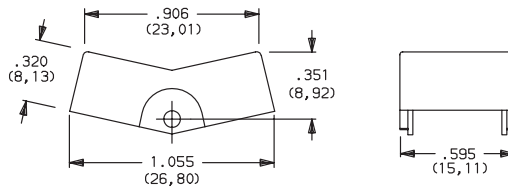

J8 ROCKER

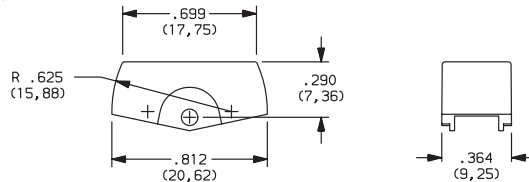

J50 ROCKER

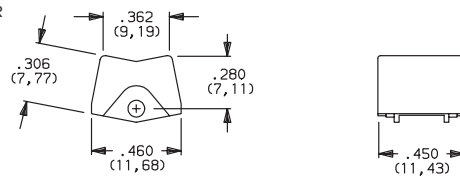

J60 LEVER

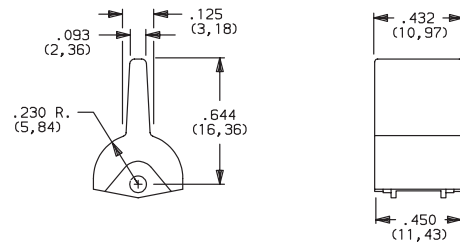

J90 LEVER

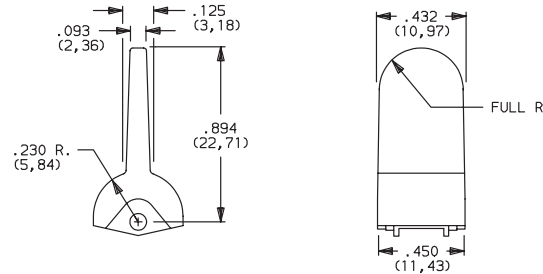

TERMINATIONS



Z (STD.) SOLDER LUG

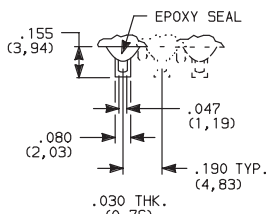

C (STD.) PC THRU-HOLE

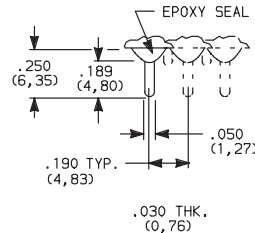

PC MOUNTING

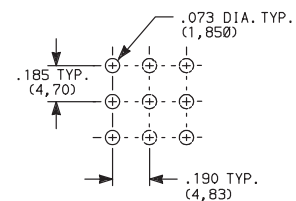

Not available with K, L or M contact materials.
Available actuators, see page G-27.

SPDT thru 3PDT



Dimensions are shown: IN (mm)
Dimensions subject to change

Rocker



SPDT thru 3PDT



Cannon

C&K E Series Sealed Miniature Rocker and Lever Handle Switches

TERMINATIONS

Z3 QUICK CONNECT

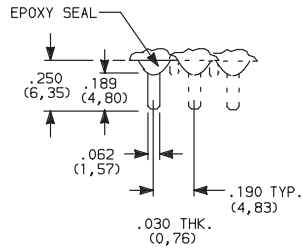

Not available with K, L or M contact materials. Available actuators, see pages G-28 thru G-29. Mating quick connector available; order part number 530100000, page G-37.

SPDT thru 3PDT

W, W4 WIRE WRAP

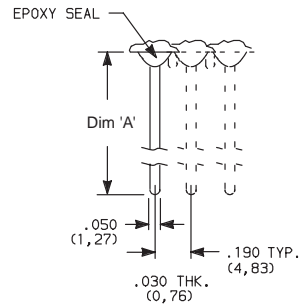

OPTION CODE	DIM 'A'
W	.750 (19,05)
W1	.964 (24,48)
W3	.425 (10,80)
W4	1.062 (26,97)
W5	1.305 (33,15)

SPDT thru 3PDT

NOTE: Available actuators, see pages G-28 thru G-29.

A (STD.) RIGHT ANGLE, PC THRU-HOLE



E101J1ABE2
Horizontal Actuation
SPDT

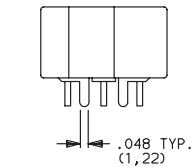

Actuator Shown In Pos. 1

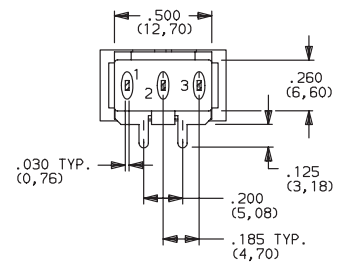
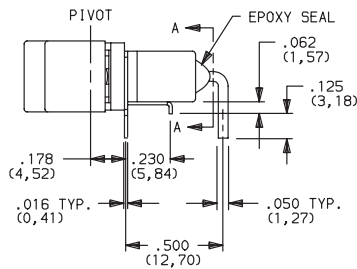

SECTION A-A

A3 RIGHT ANGLE, SNAP-IN, PC THRU-HOLE

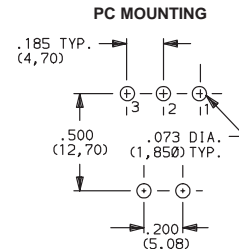
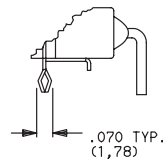
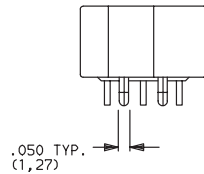

PC MOUNTING

NOTE: Not available with J3, J50, J60 and J90 actuators. Available actuators, see pages G-28 thru G-29. Terminal bend radii and lead-in manufacturing option.

NOTE: PC mounting pattern must clear switch support leg.

A (STD.) RIGHT ANGLE, PC THRU-HOLE



E201J1ABE2
Horizontal Actuation
DPDT

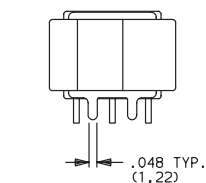

Actuator Shown In Pos. 1

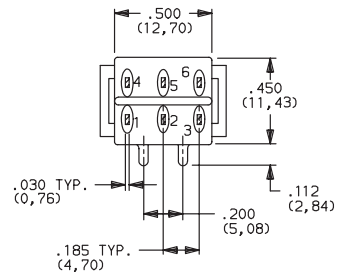
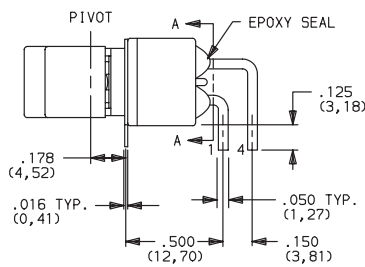

SECTION A-A

A3 RIGHT ANGLE, SNAP-IN, PC THRU-HOLE

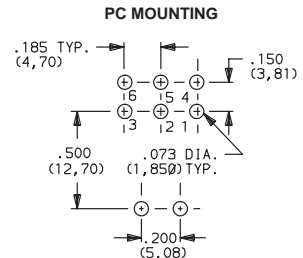
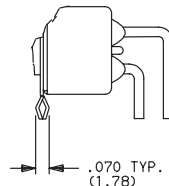
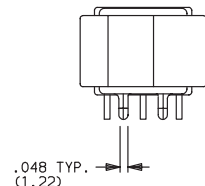

PC MOUNTING

NOTE: Not available with J3 actuator. Available actuators, see pages G-28 and G-29. Terminal bend radii and lead-in manufacturing option.

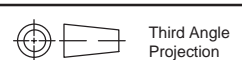

Dimensions are shown: IN (mm)
Dimensions subject to change

Rocker



G

C&K E Series Sealed Miniature Rocker and Lever Handle Switches

TERMINATIONS

A (STD.) RIGHT ANGLE, PC THRU-HOLE

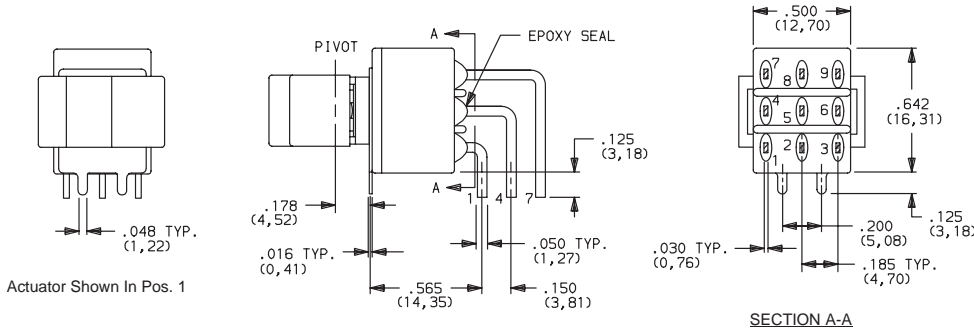

PC MOUNTING

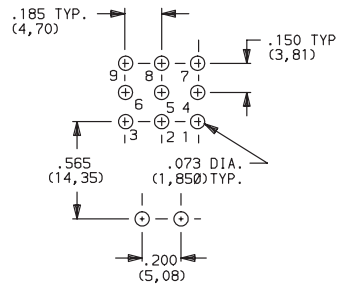

NOTE: Terminal bend radii and lead-in manufacturing option. Available actuators, see pages G-28 and G-29.

AV2 (STD.) VERTICAL RIGHT ANGLE, PC THRU-HOLE, .150" PITCH

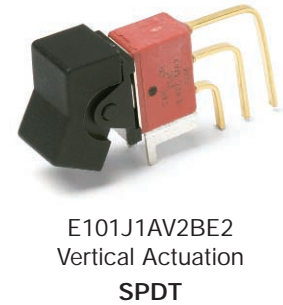
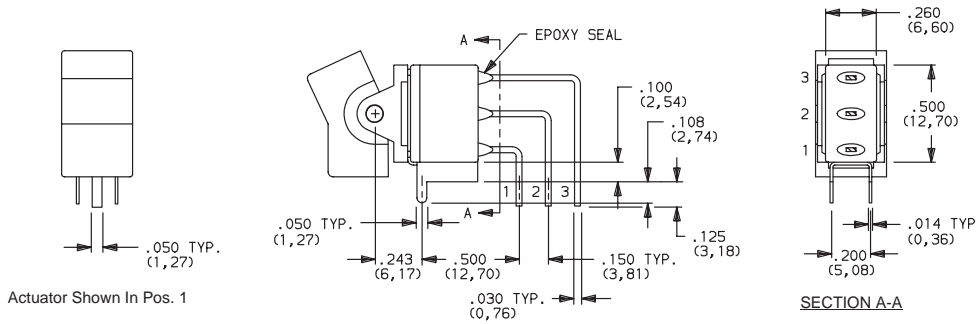

AV3 VERTICAL RIGHT ANGLE, SNAP-IN, PC THRU-HOLE, .150" PITCH

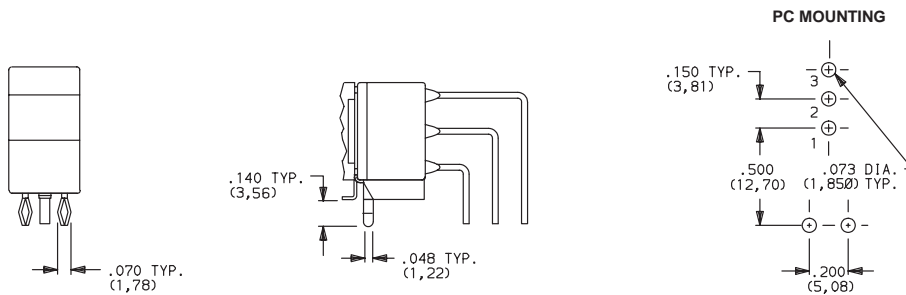

NOTE: Terminal bend radii and lead-in manufacturing option. Available actuators, see pages G-28 and G-29.

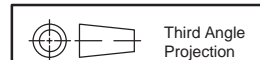

Dimensions are shown: IN (mm)
Dimensions subject to change

www.ittcannon.com

Rocker



G



Cannon

C&K E Series Sealed Miniature Rocker and Lever Handle Switches

TERMINATIONS

AV2 (STD.) VERTICAL RIGHT ANGLE, PC THRU-HOLE,
.150" PITCH

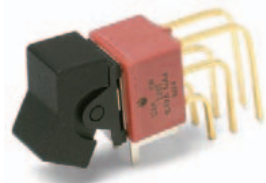

E201J1AV2BE2
Vertical Actuation
DPDT

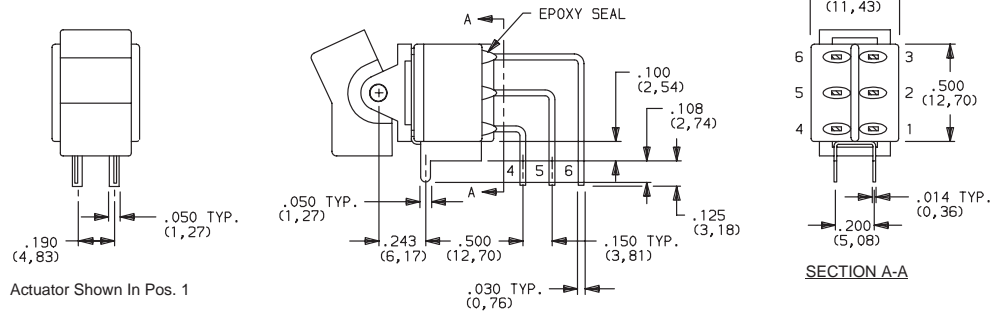

AV3 VERTICAL RIGHT ANGLE, SNAP-IN, PC THRU-HOLE,
.150" PITCH

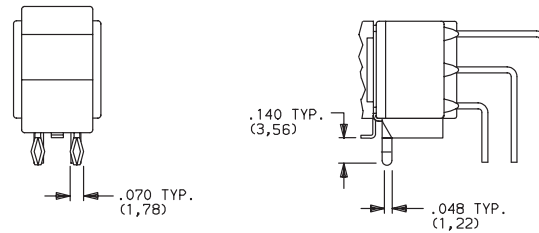

PC MOUNTING

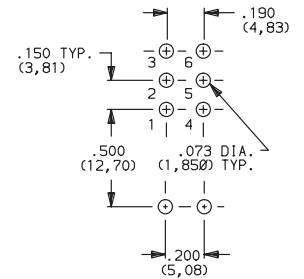

NOTE: Terminal bend radii and lead-in manufacturing option.
Available actuators, see pages G-28 and G-29.

AV2 (STD.) VERTICAL RIGHT ANGLE, PC THRU-HOLE,
.150" PITCH

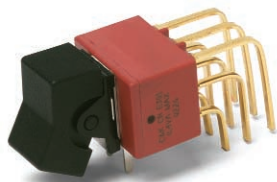

E301J1AV2BE2
Vertical Actuation
3PDT

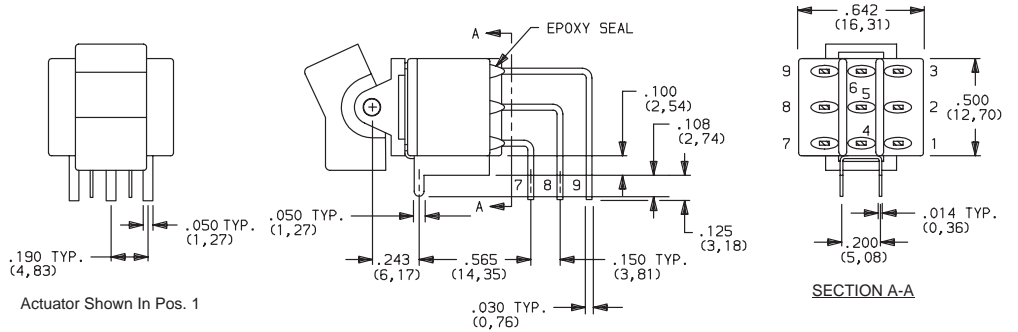

AV3 VERTICAL RIGHT ANGLE, SNAP-IN, PC THRU-HOLE,
.150" PITCH

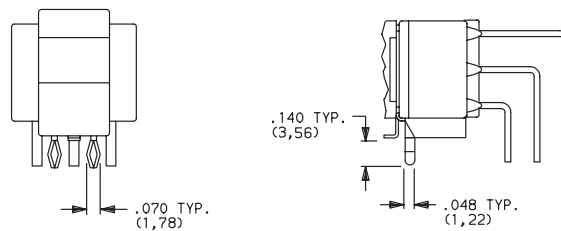

PC MOUNTING

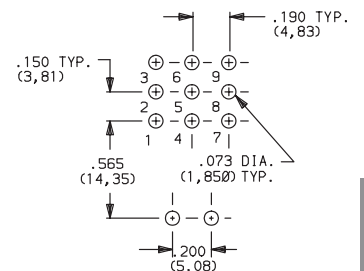

NOTE: Terminal bend radii and lead-in manufacturing option.
Available actuators, see pages G-28 and G-29.

Rocker



G

C&K E Series Sealed Miniature Rocker and Lever Handle Switches

TERMINATIONS

AW3 VERTICAL RIGHT ANGLE, EXTENDED, PC THRU-HOLE

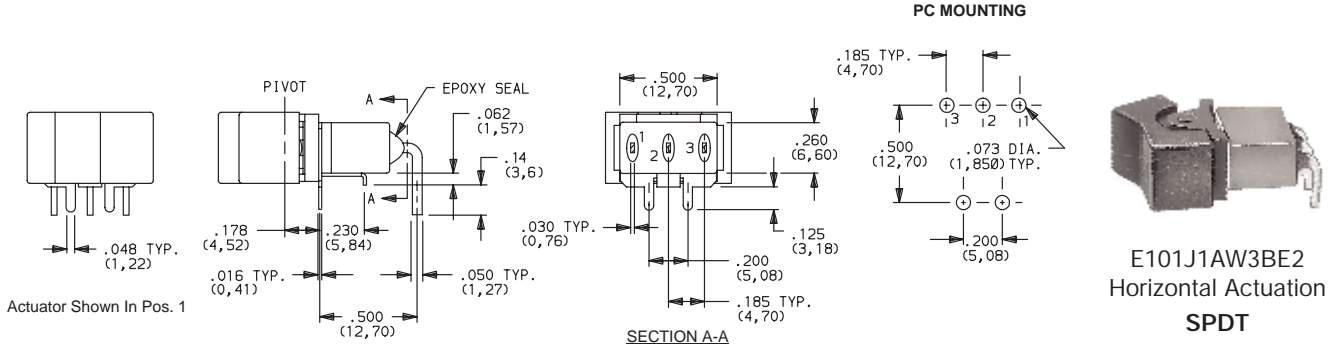

NOTE: PC mounting pattern must clear switch support leg.

V5 VERTICAL RIGHT ANGLE, PC THRU-HOLE,
.150" PITCH

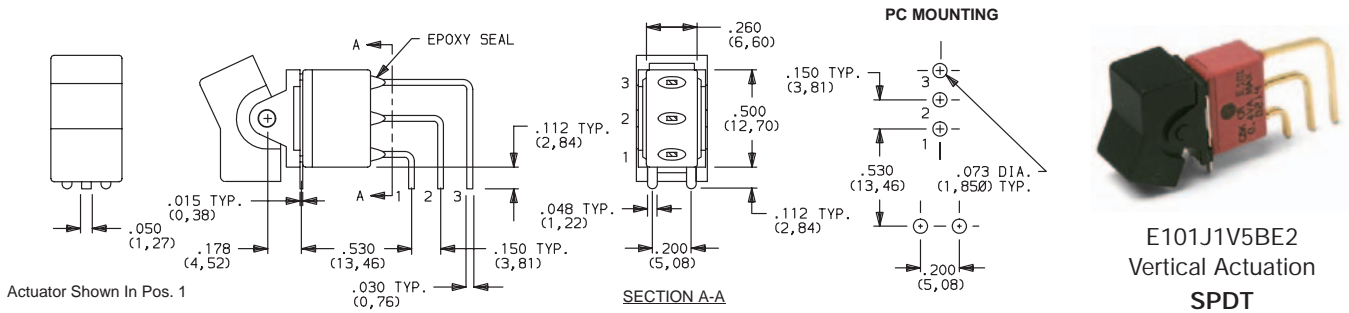

NOTE: Terminal bend radii and lead-in manufacturing option.
Available actuators, see pages G-28 and G-29.

V5 VERTICAL RIGHT ANGLE, PC THRU-HOLE,
.150" PITCH

Rocker

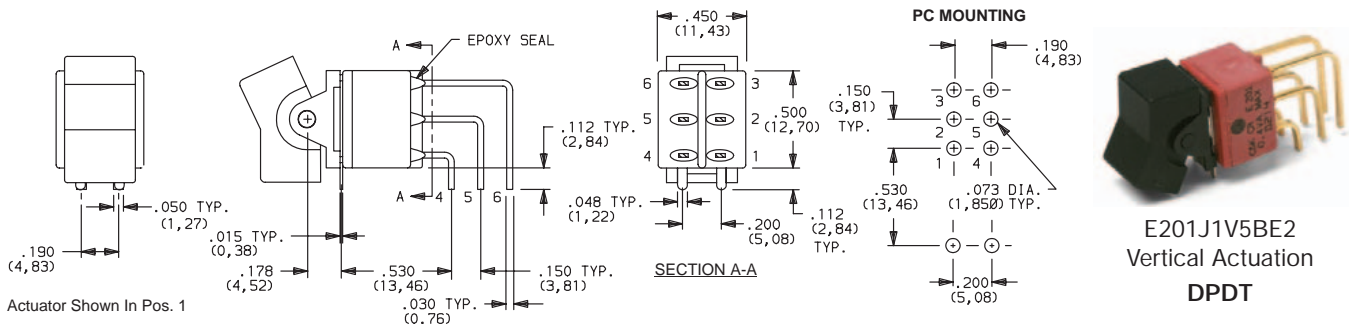

NOTE: Terminal bend radii and lead-in manufacturing option.
Available actuators, see pages G-28 and G-29.

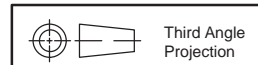

Dimensions are shown: IN (mm)
Dimensions subject to change

www.ittcannon.com

C&K E Series Sealed Miniature Rocker and Lever Handle Switches

TERMINATIONS

V2, V6, V7, V8 VERTICAL MOUNT, V-BRACKET

V21, V61 VERTICAL MOUNT, V-BRACKET, SNAP-IN



E101J1_BE2
SPDT

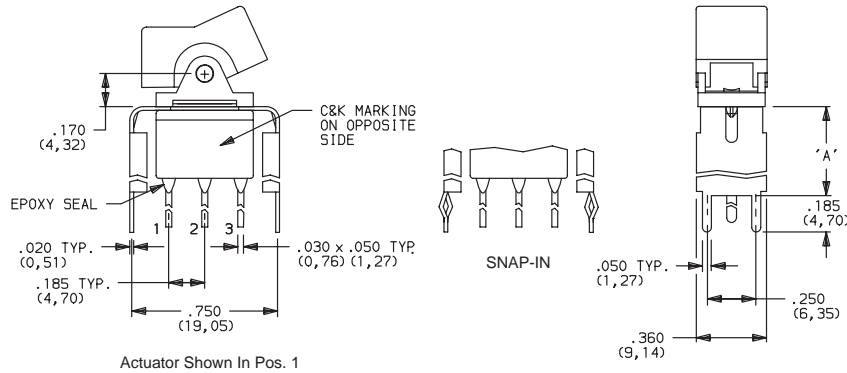

PC MOUNTING

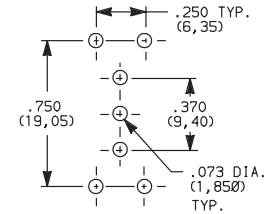

OPTION CODE	DIM 'A'
V2, V21	.555 (14, 10)
V6, V61	.460 (11, 68)
V7	.630 (16, 00)
V8	.953 (24, 21)

NOTE: Available actuators, see pages G-28 and G-29.

V2, V6, V7, V8 VERTICAL MOUNT, V-BRACKET

V21, V61 VERTICAL MOUNT, V-BRACKET, SNAP-IN



E201J1_BE2
DPDT

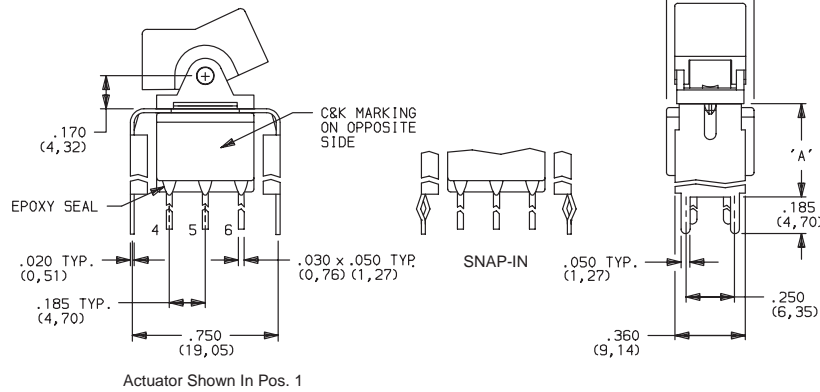

PC MOUNTING

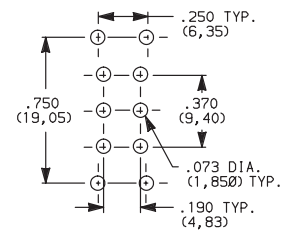

OPTION CODE	DIM 'A'
V2, V21	.555 (14, 10)
V6, V61	.460 (11, 68)
V7	.630 (16, 00)
V8	.953 (24, 21)

NOTE: Available actuators, see pages G-28 and G-29.

V2, V7, V8 VERTICAL MOUNT, V-BRACKET

V21 VERTICAL MOUNT, V-BRACKET, SNAP-IN



E301J1_BE2
3PDT

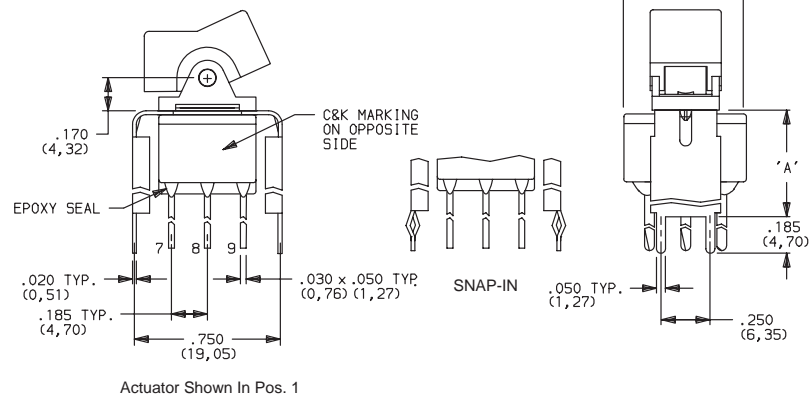

PC MOUNTING

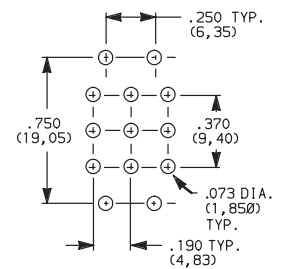

OPTION CODE	DIM 'A'
V2, V21	.555 (14, 10)
V7	.630 (16, 00)
V8	.953 (24, 21)

NOTE: Available actuators, see pages G-28 and G-29.

Rocker



G

C&K E Series Sealed Miniature Rocker and Lever Handle Switches

TERMINATIONS

V3, V4, V9 VERTICAL MOUNT, V-BRACKET

V31, V41 VERTICAL MOUNT, V-BRACKET, SNAP-IN

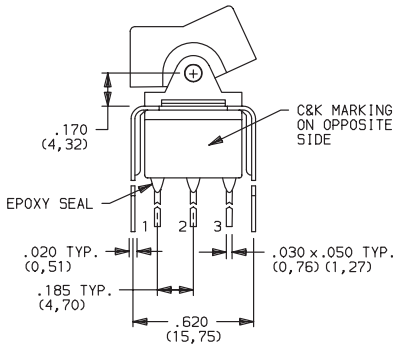

Actuator Shown In Pos. 1

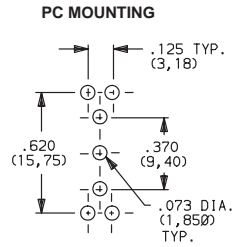
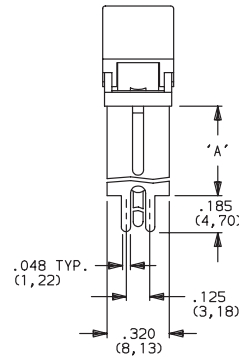
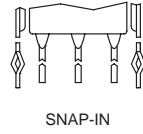

E101J1_BE2
SPDT

OPTION CODE	DIM 'A'
V3, V31	.460 (11,68)
V4, V41	.630 (16,00)
V9	1.150 (29,21)

V3, V4, V9 VERTICAL MOUNT, V-BRACKET

V31, V41 VERTICAL MOUNT, V-BRACKET, SNAP-IN

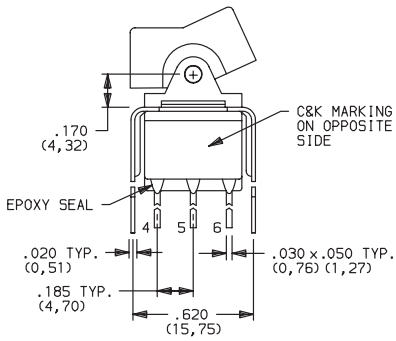

Actuator Shown In Pos. 1

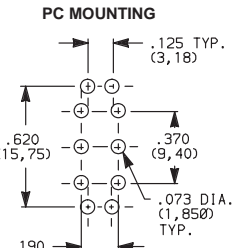
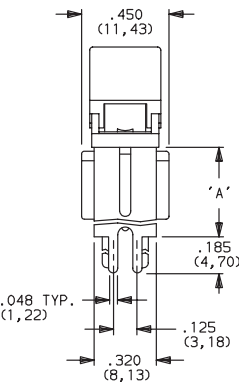
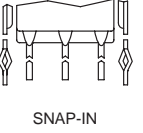

E201J1_BE2
DPDT

OPTION CODE	DIM 'A'
V3, V31	.460 (11,68)
V4, V41	.630 (16,00)
V9	1.150 (29,21)

V4, V9 VERTICAL MOUNT, V-BRACKET

V41 VERTICAL MOUNT, V-BRACKET, SNAP-IN

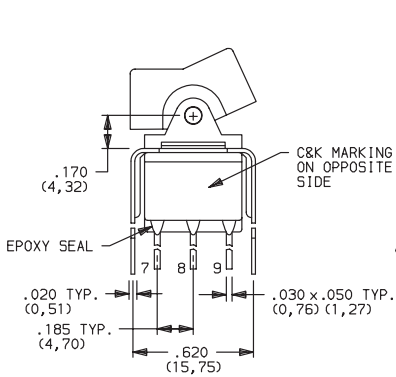

Actuator Shown In Pos. 1

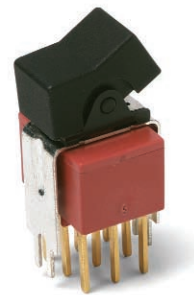
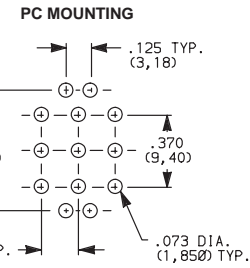
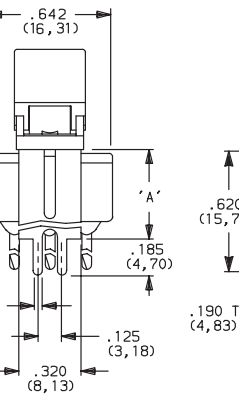
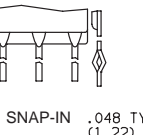

E301J1_BE2
3PDT

OPTION CODE	DIM 'A'
V4, V41	.630 (16,00)
V9	1.150 (29,21)

Rocker



G

NOTE: Available actuators, see pages G-28 and G-29.



Dimensions are shown: IN (mm)
Dimensions subject to change

C&K E Series Sealed Miniature Rocker and Lever Handle Switches

CONTACT MATERIAL

OPTION CODE	CONTACT MATERIAL	TERMINAL PLATING	RATINGS	
B (STD.)	GOLD ¹	GOLD ¹	LOW LEVEL/DRY CIRCUIT	0.4 VA MAX. @ 20 V AC OR DC MAX.
K		TIN-LEAD ⁶		
Q (STD.)	SILVER ^{4,5}	SILVER ⁵	POWER	E1XX & E2XX MODELS: 7.5 AMPS @125 V AC OR 28 V DC; 3 AMPS @ 250 V AC. E3XX MODELS: 5 AMPS @ 125 V AC OR 28 V DC; 2 AMPS @ 250 V AC.
M		TIN-LEAD ⁶		
G	GOLD OVER SILVER ^{2,3}	GOLD ³	LOW LEVEL/DRY CIRCUIT OR POWER	E1XX AND E2XX MODELS: 0.4 VA MAX @20 V AC OR DC MAX. OR 7.5 AMPS @125 V AC OR 28 V DC; 3 AMPS @ 250 V AC. DC E3XX MODELS: 0.4 VA MAX. @ 20 V AC OR DC MAX. OR 5 AMPS @ 125 V AC OR 28 V DC; 2 AMPS @ 250 V AC.
L		TIN-LEAD ⁶		

CONTACT MATERIAL/APPLICATION RECOMMENDATIONS—SEE SECTION N.

¹ CONTACTS & TERMINALS: Copper alloy, with gold plate over nickel plate.



² END CONTACTS: Coin silver, with gold plate over nickel plate.

³ CENTER CONTACTS & ALL TERMINALS: Copper alloy, with gold plate over nickel plate.

⁴ END CONTACTS: Coin silver, silver plated.

⁵ CENTER CONTACT & ALL TERMINALS: Copper alloy, silver plated.

⁶ TERMINALS: Copper alloy, with tin-lead alloy over nickel plate.

All models   with all options when ordered with G, L, M or Q contact material. B contact material standard with all terminations.

K, L & M contact materials not available with Z & Z3 terminations.

SEAL

E (STD.) EPOXY SEAL

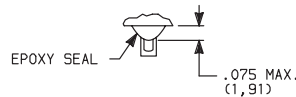

AVAILABLE HARDWARE

J2, J21 Actuators



PART NO.

760501000 WHITE
760502263 BLACK
760503000 RED

Material: Nylon
Finish: Matte

J3 Actuator



PART NO.

766601000 WHITE
766602263 BLACK
766603000 RED

Material: Nylon
Finish: Matte

J1, J11 Actuators

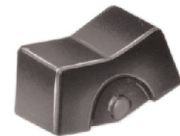

PART NO.

760201000 WHITE
760202263 BLACK
760203000 RED

Material: Nylon
Finish: Matte

J50 Actuator



PART NO.

628301000 WHITE
628302263 BLACK
628303000 RED

Material: Nylon
Finish: Matte

J60 Actuator



PART NO.

598101000 WHITE
613802263 BLACK
598103000 RED

Material: Nylon
Finish: Matte

J90 Actuator



PART NO.

598001000 WHITE
598002263 BLACK
598003000 RED

Material: Nylon
Finish: Matte

NOTE: Additional nuts, screws and lockwashers available separately, see Section N. Other colors available, consult Customer Service Center.

Rocker



G

C&K E Series Sealed Miniature Rocker and Lever Handle Switches

AVAILABLE HARDWARE

Fits Z3 Termination female connector



PART NO.
530100000

Available in loose pieces.

Frame for J11, J21 Actuators



PART NO.
764500746 BLACK ENAMEL
764500747 WHITE ENAMEL
764601106 RETAINING SPRING
Material: Spring Steel

J50, J60 & J90 Actuators

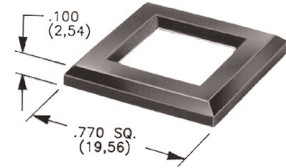

MATTE	GLOSS	
PART NO.	PART NO.	
486701000	486801000	WHITE
486702000	486802000	BLACK
486703000	486803000	RED
Material: Nylon		
Finish: Matte or Gloss		

NOTE: Additional nuts, screws and lockwashers available separately, see Section N.
Other colors available, consult Customer Service Center.

Frames snap into panel opening and are independent from switch mounting. Accurate positioning of the PC mounted switch relative to the panel opening is necessary to provide proper clearance between actuator and frame. Available in two basic styles and four panel thicknesses .047-.125 in. Material: Nylon. Finish: Matte.

TYPICAL APPLICATION

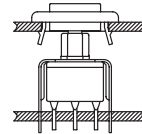

J1 & J2 Actuators

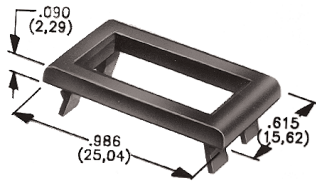

.047" (1,19) PANEL THK.	.062" (1,57) PANEL THK.	.090" (2,29) PANEL THK.	.125" (3,18) PANEL THK.
PART NO.	PART NO.	PART NO.	PART NO.
452901000	452701000	452801000	452601000 WHITE
452902263	452702263	452802263	452602263 BLACK
452903000	452703000	452803000	452603000 RED

J50, J60 & J90 Actuators

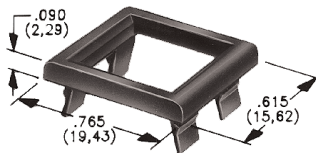

.047" (1,19) PANEL THK.	.062" (1,57) PANEL THK.	.090" (2,29) PANEL THK.	.125" (3,18) PANEL THK.
PART NO.	PART NO.	PART NO.	PART NO.
432501000	432601000	432701000	432801000 WHITE
432502263	432602263	432702263	432802263 BLACK
432503000	432603000	432703000	432803000 RED

PANEL MOUNTING

For part numbers
4529xxxxx, 4527xxxxx,
4528xxxxx, 4526xxxxx

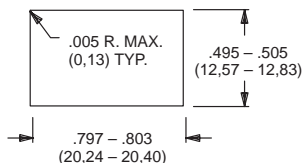

For part numbers
4325xxxxx, 4326xxxxx

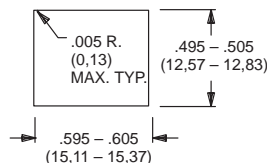

For part numbers
4327xxxxx, 4328xxxxx

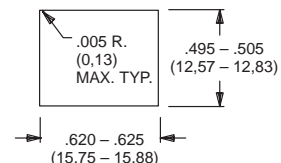

Dimensions are shown: IN (mm)
Dimensions subject to change

Rocker



G

C&K E Series Sealed Miniature Rocker and Lever Handle Switches

AVAILABLE HARDWARE

Panel Inserts

Will fit separate snap-in frames for J50, J60, J90 actuators.

Above frames (part nos. 432XXXXXX) are also available with insert which accepts LED for indicator light assembly. Order insert separately from frame. Blank insert panel (without hole for LED) also available. **LED not included.**

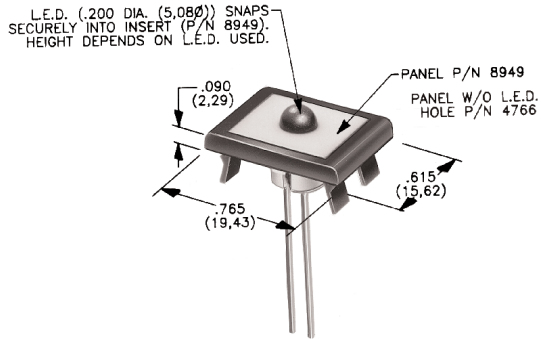

PANEL INSERT
WITH HOLE FOR LED

BLANK PANEL INSERT
WITHOUT HOLE FOR LED

PART NO.

894901000
894902000
894903000

PART NO.

476601000 WHITE
476602000 BLACK
476603000 RED

Special colors, custom markings available, consult Customer Service Center.

Rocker



G



Third Angle
Projection
Dimensions are shown: IN (mm)
Dimensions subject to change