

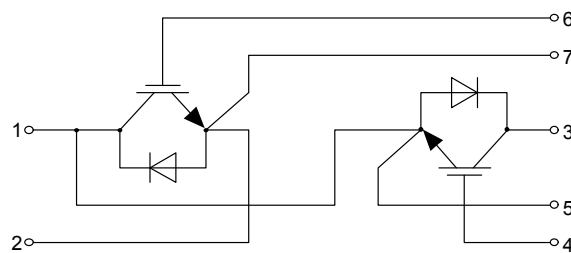

European Power-Semiconductor and Electronics Company

Marketing Information

BSM 150 GB 170 DL

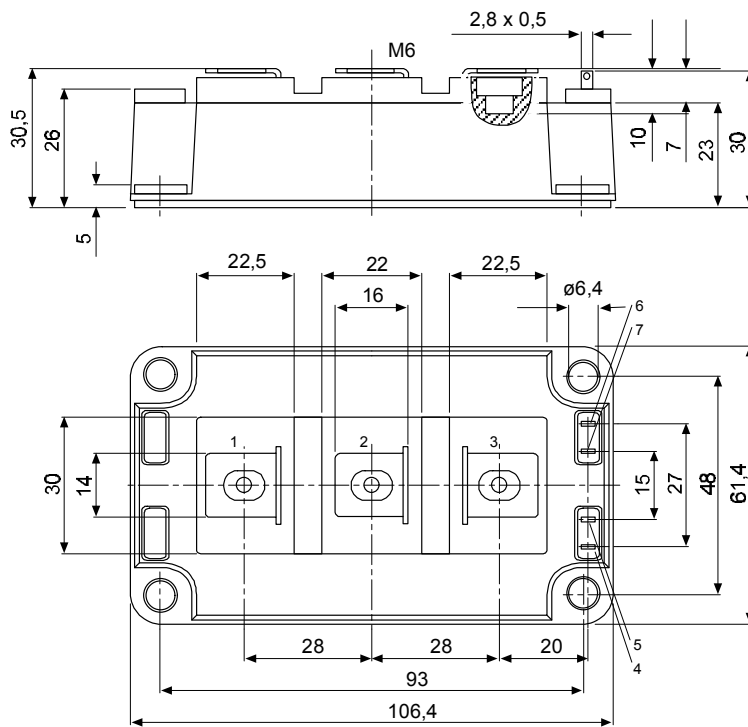

23.04.1998

BSM 150 GB 170 DL

vorläufige Daten
preliminary data

Höchstzulässige Werte / Maximum rated values Elektrische Eigenschaften / Electrical properties

Kollektor-Emitter-Sperrspannung	collector-emitter voltage		V_{CES}	1700 V
Kollektor-Dauergleichstrom	DC-collector current	$T_C = 80^\circ\text{C}$	$I_{C,nom.}$	150 A
		$T_C = 25^\circ\text{C}$	I_C	300 A
Periodischer Kollektor Spitzenstrom	repetitive peak collector current	$t_p = 1 \text{ ms}, T_C = 80^\circ\text{C}$	I_{CRM}	300 A
Gesamt-Verlustleistung	total power dissipation	$T_C = 25^\circ\text{C}, \text{ Transistor}$	P_{tot}	1250 W
Gate-Emitter-Spitzenspannung	gate-emitter peak voltage		V_{GES}	$\pm 20 \text{ V}$
Dauergleichstrom	DC forward current		I_F	150 A
Periodischer Spitzenstrom	repetitive peak forw. current	$t_p = 1 \text{ ms}$	I_{FRM}	300 A
Grenzlastintegral der Diode	I^2t - value, Diode	$V_R = 0\text{V}, t_p = 10\text{ms}, T_{vj} = 125^\circ\text{C}$	$\int I^2t$	7200 A ² s
Isolations-Prüfspannung	insulation test voltage	RMS, f = 50 Hz, t = 1 min.	V_{ISOL}	3,4 kV

Charakteristische Werte / Characteristic values: Transistor

				min.	typ.	max.
Kollektor-Emitter Sättigungsspannung	collector-emitter saturation voltage	$I_C = 150\text{A}, V_{GE} = 15\text{V}, T_{vj} = 25^\circ\text{C}$	$V_{CE \text{ sat}}$	-	2,7	3,3 V
		$I_C = 150\text{A}, V_{GE} = 15\text{V}, T_{vj} = 125^\circ\text{C}$		-	3,2	- V
Gate-Schwellenspannung	gate threshold voltage	$I_C = 7\text{mA}, V_{CE} = V_{GE}, T_{vj} = 25^\circ\text{C}$	$V_{GE(th)}$	4,5	5,5	6,5 V
Eingangskapazität	input capacitance	f = 1MHz, $T_{vj} = 25^\circ\text{C}, V_{CE} = 25\text{V}, V_{GE} = 0\text{V}$	C_{ies}	-	10	- nF
Kollektor-Emitter Reststrom	collector-emitter cut-off current	$V_{CE} = 1700\text{V}, V_{GE} = 0\text{V}, T_{vj} = 25^\circ\text{C}$	I_{CES}	-	0,05	0,3 mA
		$V_{CE} = 1700\text{V}, V_{GE} = 0\text{V}, T_{vj} = 125^\circ\text{C}$		-	4	- mA
Gate-Emitter Reststrom	gate-emitter leakage current	$V_{CE} = 0\text{V}, V_{GE} = 20\text{V}, T_{vj} = 25^\circ\text{C}$	I_{GES}	-	-	200 nA
Einschaltverzögerungszeit (induktive Last)	turn-on delay time (inductive load)	$I_C = 150\text{A}, V_{CE} = 900\text{V}$	$t_{d,on}$	-	-	-
		$V_{GE} = \pm 15\text{V}, R_G = 10\Omega, T_{vj} = 25^\circ\text{C}$		-	0,1	- μs
		$V_{GE} = \pm 15\text{V}, R_G = 10\Omega, T_{vj} = 125^\circ\text{C}$		-	0,1	- μs
Anstiegszeit (induktive Last)	rise time (inductive load)	$I_C = 150\text{A}, V_{CE} = 900\text{V}$	t_r	-	-	-
		$V_{GE} = \pm 15\text{V}, R_G = 10\Omega, T_{vj} = 25^\circ\text{C}$		-	0,1	- μs
		$V_{GE} = \pm 15\text{V}, R_G = 10\Omega, T_{vj} = 125^\circ\text{C}$		-	0,1	- μs
Abschaltverzögerungszeit (ind. Last)	turn off delay time (inductive load)	$I_C = 150\text{A}, V_{CE} = 900\text{V}$	$t_{d,off}$	-	-	-
		$V_{GE} = \pm 15\text{V}, R_G = 10\Omega, T_{vj} = 25^\circ\text{C}$		-	0,8	- μs
		$V_{GE} = \pm 15\text{V}, R_G = 10\Omega, T_{vj} = 125^\circ\text{C}$		-	0,9	- μs
Fallzeit (induktive Last)	fall time (inductive load)	$I_C = 150\text{A}, V_{CE} = 900\text{V}$	t_f	-	-	-
		$V_{GE} = \pm 15\text{V}, R_G = 10\Omega, T_{vj} = 25^\circ\text{C}$		-	0,03	- μs
		$V_{GE} = \pm 15\text{V}, R_G = 10\Omega, T_{vj} = 125^\circ\text{C}$		-	0,03	- μs
Einschaltverlustenergie pro Puls	turn-on energy loss per pulse	$I_C = 150\text{A}, V_{CE} = 900\text{V}, V_{GE} = 15\text{V}$	E_{on}	-	70	- mWs
		$R_G = 10\Omega, T_{vj} = 125^\circ\text{C}, L_S = 60\text{nH}$		-	-	-
Abschaltverlustenergie pro Puls	turn-off energy loss per pulse	$I_C = 150\text{A}, V_{CE} = 900\text{V}, V_{GE} = 15\text{V}$	E_{off}	-	46	- mWs
		$R_G = 10\Omega, T_{vj} = 125^\circ\text{C}, L_S = 60\text{nH}$		-	-	-
Kurzschlußverhalten	SC Data	$t_p \leq 10\mu\text{sec}, V_{GE} \leq 15\text{V}, R_G = 10\Omega$	I_{SC}	-	600	- A
		$T_{vj} \leq 125^\circ\text{C}, V_{CC} = 1000\text{V}$		-	-	-
		$V_{CEmax} = V_{CES} - L_{\text{SC}} \times di/dt$		-	-	-
Modulinduktivität	stray inductance module		L_{SCE}	-	30	- nH

Charakteristische Werte / Characteristic values: Diode

Durchlaßspannung	forward voltage	$I_F = 150\text{A}, V_{GE} = 0\text{V}, T_{vj} = 25^\circ\text{C}$	V_F	-	2,2	2,6 V
		$I_F = 150\text{A}, V_{GE} = 0\text{V}, T_{vj} = 125^\circ\text{C}$		-	2	- V
Rückstromspitze	peak reverse recovery current	$I_F = 150\text{A}, -di_F/dt = 2250\text{A}/\mu\text{sec}$	I_{RM}	-	110	- A
		$V_R = 900\text{V}, V_{GE} = -10\text{V}, T_{vj} = 25^\circ\text{C}$		-	165	- A
		$V_R = 900\text{V}, V_{GE} = -10\text{V}, T_{vj} = 125^\circ\text{C}$		-	-	-
Sperrverzögerungsladung	recovered charge	$I_F = 150\text{A}, -di_F/dt = 2250\text{A}/\mu\text{sec}$	Q_r	-	17	- μAs
		$V_R = 900\text{V}, V_{GE} = -10\text{V}, T_{vj} = 25^\circ\text{C}$		-	38	- μAs
		$V_R = 900\text{V}, V_{GE} = -10\text{V}, T_{vj} = 125^\circ\text{C}$		-	-	-
Abschaltenergie pro Puls	reverse recovery energy	$I_F = 150\text{A}, -di_F/dt = 2250\text{A}/\mu\text{sec}$	E_{rec}	-	8	- mWs
		$V_R = 900\text{V}, V_{GE} = -10\text{V}, T_{vj} = 25^\circ\text{C}$		-	15	- mWs
		$V_R = 900\text{V}, V_{GE} = -10\text{V}, T_{vj} = 125^\circ\text{C}$		-	-	-

Thermische Eigenschaften / Thermal properties

Innerer Wärmewiderstand	thermal resistance, junction to case	Transistor / transistor, DC	R_{thJC}	-	-	0,1 K/W
		Diode / diode, DC		-	-	0,24 K/W
Übergangs-Wärmewiderstand	thermal resistance, case to heatsink	pro Module / per Module	R_{thCK}	-	-	0,012 K/W
		$d_{\text{paste}} \leq 50\mu\text{m} / d_{\text{grease}} \leq 50\mu\text{m}$		-	-	-
Höchstzul. Sperrschichttemperatur	max. junction temperature		T_{vj}	-	-	150 °C
Betriebstemperatur	operating temperature		T_{op}	-40	-	125 °C
Lagertemperatur	storage temperature		T_{stg}	-40	-	125 °C

Mechanische Eigenschaften / Mechanical properties

Innere Isolation	internal insulation					Al ₂ O ₃
Kriechstrecke	creepage distance					20 mm
Luftstrecke	clearance					11 mm
CTI	comperative tracking index					
Anzugsdrehmoment f. mech. Befestigung	mounting torque		max.			5 Nm
Anzugsdrehmoment f. elektr. Anschlüsse	terminal connection torque	terminals M6	max.			5 Nm
Gewicht	weight		G			420 g

Mit dieser technischen Information werden Halbleiterbauelemente spezifiziert, jedoch keine Eigenschaften zugesichert. Sie gilt in Verbindung mit den zugehörigen Technischen Erläuterungen.
This technical information specifies semiconductor devices but promises no characteristics. It is valid in combination with the belonging technical notes.



Bild / Fig. 1
Ausgangskennlinie (typisch) /
Output characteristic (typical)
 $I_C = f(V_{CE})$
 $V_{GE} = 15V$



Bild / Fig. 2
Ausgangskennlinienfeld (typisch) /
Output characteristic (typical)
 $I_C = f(V_{CE})$
 $T_{vj} = 125°C$

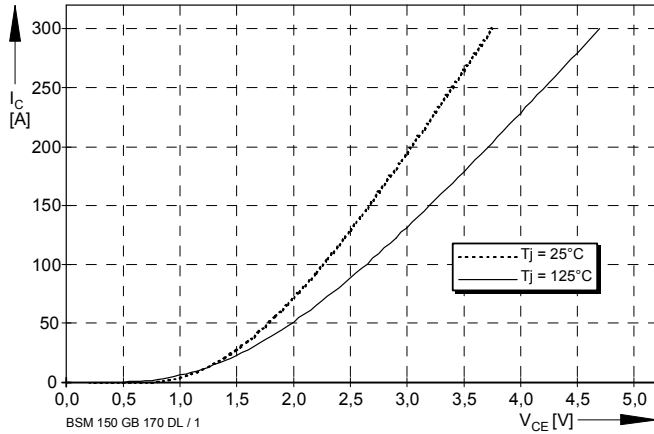

Bild / Fig. 3
Übertragungscharakteristic (typisch) /
Transfer characteristic (typical)
 $I_C = f(V_{GE})$
 $V_{CE} = 20V$

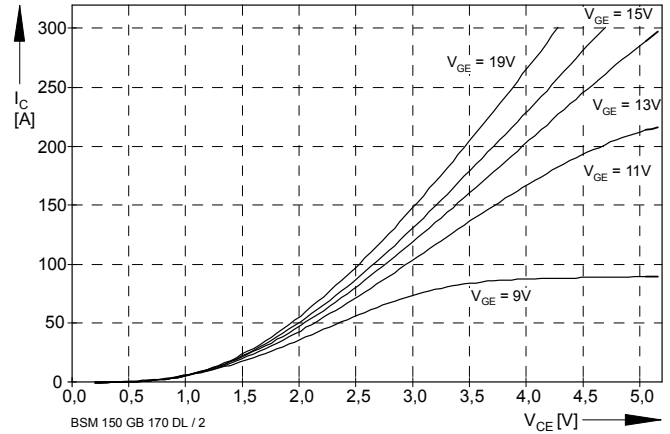

Bild / Fig. 4
Durchlaßkennlinie der Inversdiode (typisch) /
Forward characteristic of inverse diode (typical)
 $I_F = f(V_F)$

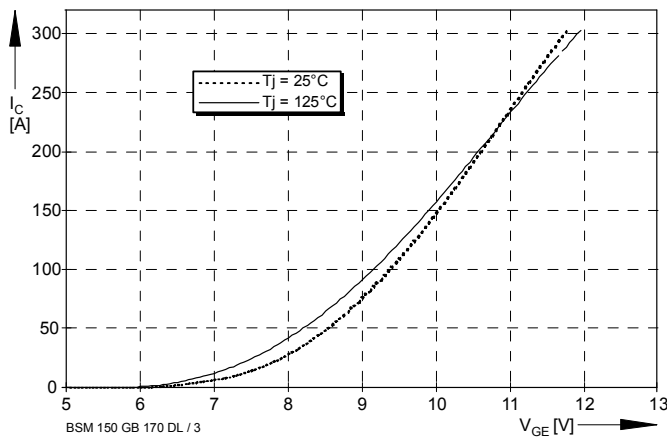

Bild / Fig. 5
Schaltverluste (typisch) /
Switching losses (typical)
 $E_{on} = f(I_C)$, $E_{off} = f(I_C)$, $E_{rec} = f(I_C)$
 $R_{gon} = R_{goff} = 10\Omega$, $V_{CE} = 900V$, $T_j = 125°C$

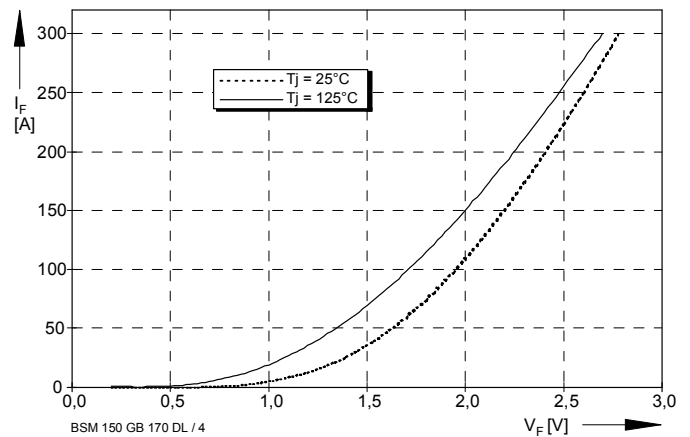

Bild / Fig. 6
Schaltverluste (typisch) /
Switching losses (typical)
 $E_{on} = f(R_G)$, $E_{off} = f(R_G)$, $E_{rec} = f(R_G)$
 $I_C = 150A$, $V_{CE} = 900V$, $T_j = 125°C$

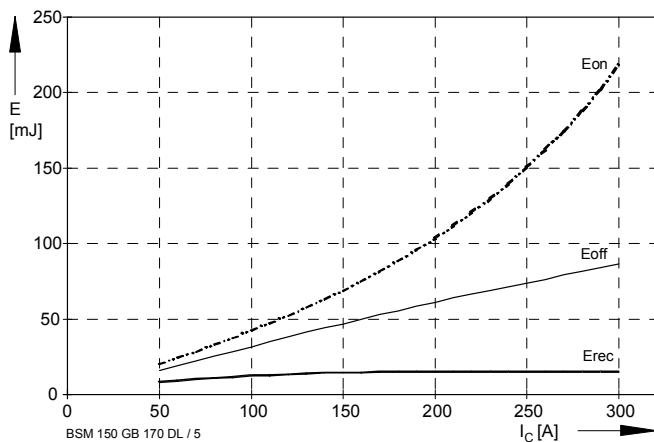
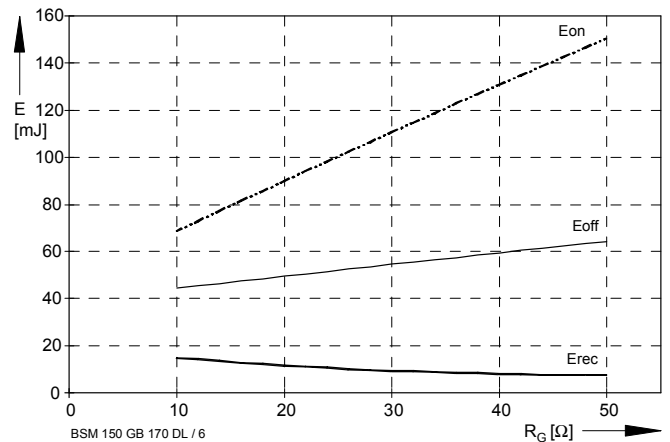
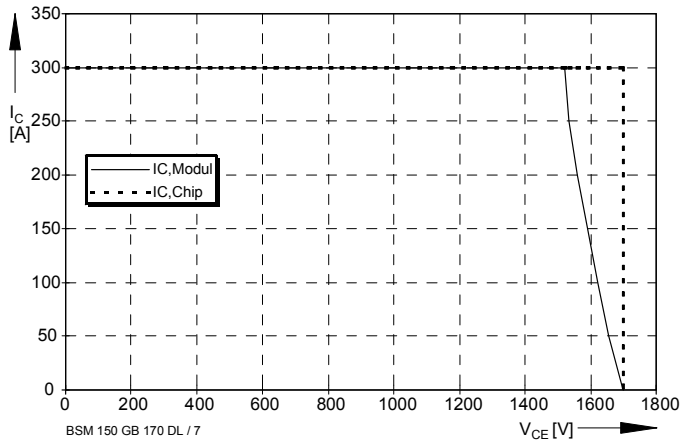

Bild / Fig. 7
Sicherer Arbeitsbereich (RBSOA) /
Reverse bias safe operation area (RBSOA)
 $R_{\theta} = 10\Omega$, $T_{vj} = 125^{\circ}\text{C}$