

Glass Passivated Single-Phase Bridge Rectifier

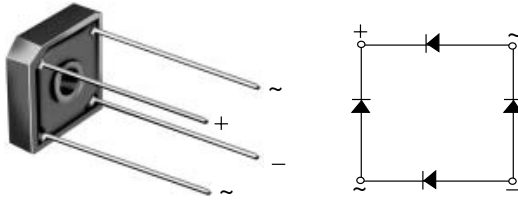

Case Style GBPC1

FEATURES

- UL recognition file number E54214
- Ideal for printed circuit boards
- Typical I_R less than 0.1 μ A
- High surge current capability
- High case dielectric strength 1500 V_{RMS}
- Solder dip 260 °C, 40 s
- Component in accordance to RoHS 2002/95/EC and WEEE 2002/96/EC

RoHS
COMPLIANT

TYPICAL APPLICATIONS

General purpose use in ac-to-dc bridge full wave rectification for switching power supply, home appliances, office equipment, industrial automation applications.

MECHANICAL DATA

Case: GBPC1

Epoxy meets UL 94V-0 flammability rating

Terminals: Silver plated leads, solderable per J-STD-002 and JESD22-B102

E4 suffix for consumer grade

Polarity: As marked, positive lead by beveled corner

Mounting Torque: 10 cm·kg (8.8 inches·lbs) max.

Recommended Torque: 5.7 cm·kg (5 inches·lbs)

PRIMARY CHARACTERISTICS

$I_{F(AV)}$	3 A
V_{RRM}	50 V to 1000 V
I_{FSM}	60 A
I_R	5 μ A
V_F	1.0 V
T_J max.	150 °C

MAXIMUM RATINGS ($T_A = 25$ °C unless otherwise noted)

PARAMETER	SYMBOL	GBPC 1005	GBPC 101	GBPC 102	GBPC 104	GBPC 106	GBPC 108	GBPC 110	UNIT
Maximum repetitive peak reverse voltage	V_{RRM}	50	100	200	400	600	800	1000	V
Maximum RMS bridge input voltage	V_{RMS}	35	70	140	280	420	560	700	V
Maximum DC blocking voltage	V_{DC}	50	100	200	400	600	800	1000	V
Maximum average forward rectified output current at $T_C = 60$ °C ⁽¹⁾ $T_A = 25$ °C ⁽²⁾	$I_{F(AV)}$	3.0 2.0							A
Peak forward surge current single sine-wave superimposed on rated load	I_{FSM}	60							A
Rating for fusing ($t < 8.3$ ms)	I^2t	15							A ² s
Operating junction and storage temperature range	T_J, T_{STG}	- 55 to + 150							°C

Notes:

(1) Unit mounted on 4.0 x 4.0 x 0.11" thick (10.5 x 10.5 x 0.3 cm) aluminum Plate

(2) Unit mounted on P.C.B. at 0.375" (9.5 mm) lead length with 0.5 x 0.5" (12 x 12 mm) copper pads

ELECTRICAL CHARACTERISTICS ($T_A = 25\text{ }^\circ\text{C}$ unless otherwise noted)										
PARAMETER	TEST CONDITIONS	SYMBOL	GBPC 1005	GBPC 101	GBPC 102	GBPC 104	GBPC 106	GBPC 108	GBPC 110	UNIT
Maximum instantaneous forward voltage drop per diode	1.5 A	V_F	1.0							V
Maximum DC reverse current at rated DC blocking voltage per diode	$T_A = 25\text{ }^\circ\text{C}$ $T_A = 125\text{ }^\circ\text{C}$	I_R	5.0 500							μA
Typical junction capacitance per diode	4.0 V, 1 MHz	C_J	21							pF

THERMAL CHARACTERISTICS ($T_A = 25\text{ }^\circ\text{C}$ unless otherwise noted)										
PARAMETER	SYMBOL	GBPC 1005	GBPC 101	GBPC 102	GBPC 104	GBPC 106	GBPC 108	GBPC 110	UNIT	
Typical thermal resistance ⁽¹⁾	$R_{\theta JA}$ $R_{\theta JC}$	12 8.0							$^\circ\text{C/W}$	

Note:

(1) Bolt down on heat-sink with silicone thermal compound between bridge and mounting surface for maximum heat transfer with #6 screw

ORDERING INFORMATION (Example)				
PREFERRED P/N	UNIT WEIGHT (g)	PREFERRED PACKAGE CODE	BASE QUANTITY	DELIVERY MODE
GBPC106-E4/51	2.5	51	100	Paper box

RATINGS AND CHARACTERISTICS CURVES

($T_A = 25\text{ }^\circ\text{C}$ unless otherwise noted)

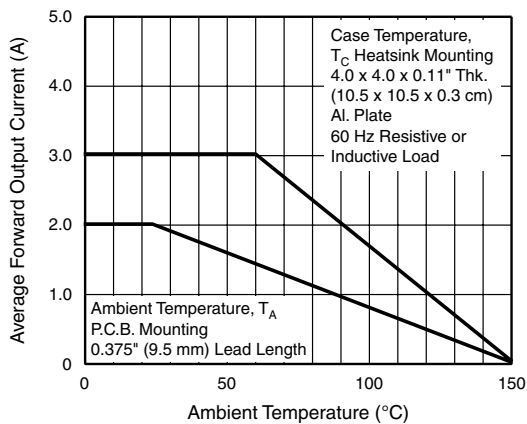

Figure 1. Derating Curve Output Rectified Current

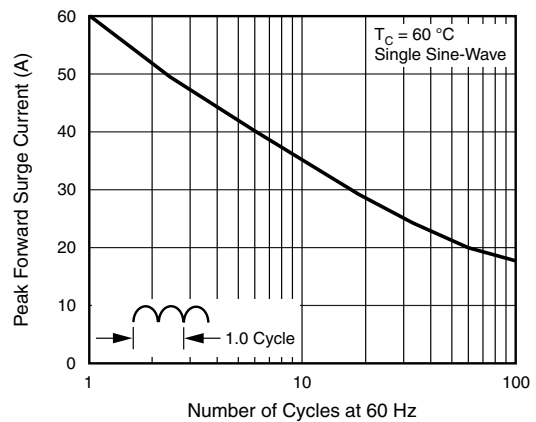

Figure 2. Maximum Non-Repetitive Peak Forward Surge Current Per Diode

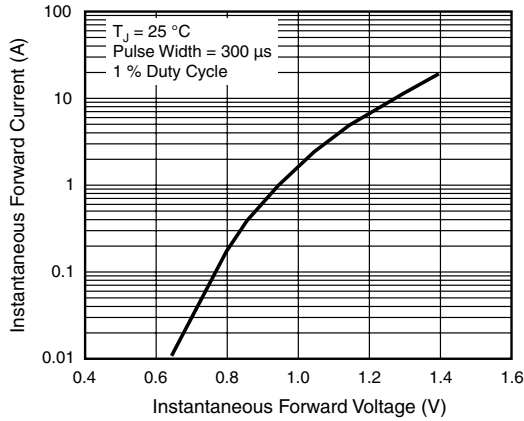

Figure 3. Typical Forward Characteristics Per Diode

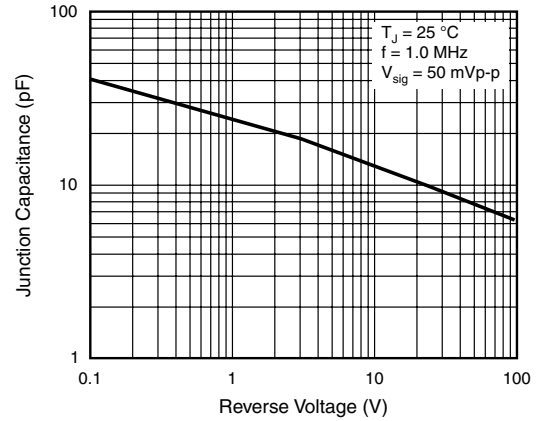

Figure 5. Typical Junction Capacitance Per Diode

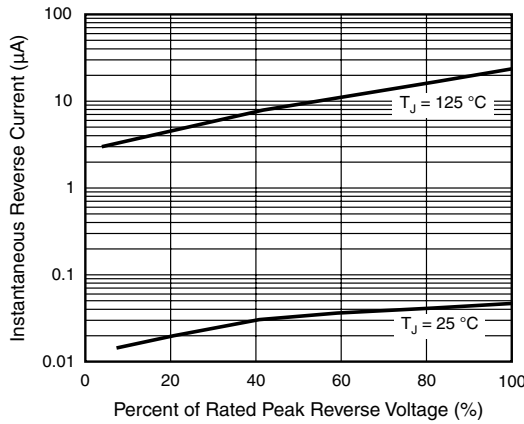

Figure 4. Typical Reverse Leakage Characteristics Per Diode

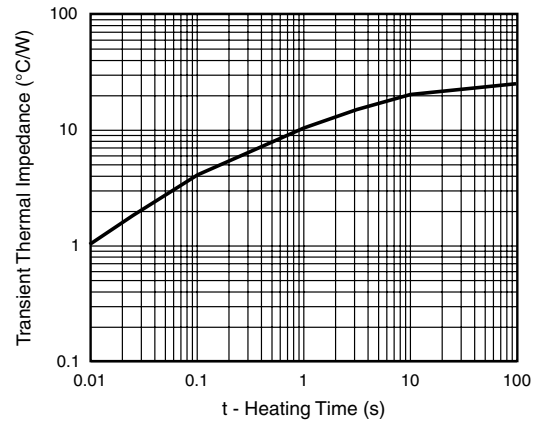
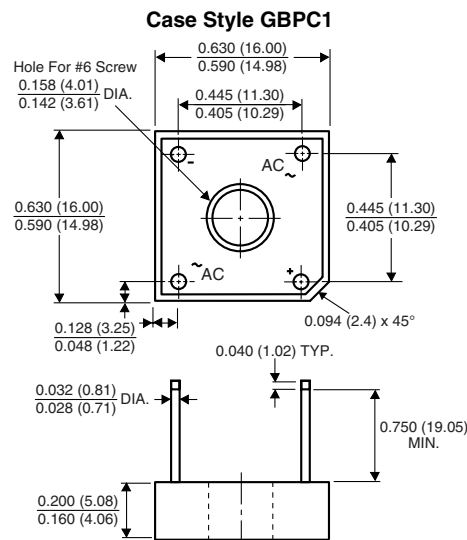

Figure 6. Typical Transient Thermal Impedance Per Diode

PACKAGE OUTLINE DIMENSIONS in inches (millimeters)



Polarity shown on side of case: Positive lead by beveled corner



Disclaimer

All product specifications and data are subject to change without notice.

Vishay Intertechnology, Inc., its affiliates, agents, and employees, and all persons acting on its or their behalf (collectively, "Vishay"), disclaim any and all liability for any errors, inaccuracies or incompleteness contained herein or in any other disclosure relating to any product.

Vishay disclaims any and all liability arising out of the use or application of any product described herein or of any information provided herein to the maximum extent permitted by law. The product specifications do not expand or otherwise modify Vishay's terms and conditions of purchase, including but not limited to the warranty expressed therein, which apply to these products.

No license, express or implied, by estoppel or otherwise, to any intellectual property rights is granted by this document or by any conduct of Vishay.

The products shown herein are not designed for use in medical, life-saving, or life-sustaining applications unless otherwise expressly indicated. Customers using or selling Vishay products not expressly indicated for use in such applications do so entirely at their own risk and agree to fully indemnify Vishay for any damages arising or resulting from such use or sale. Please contact authorized Vishay personnel to obtain written terms and conditions regarding products designed for such applications.

Product names and markings noted herein may be trademarks of their respective owners.