

# RTA Series

## 1-4 Poles Coded Rotary Switches



### Features/Benefits

- PCB or hand soldering versions
- Bushing mounting
- Multiple poles
- Decimal and hexadecimal codes
- Screwdriver slot or extended actuator
- RoHS Compliant

### Typical Applications

- Appliances
- Electronic alarm systems
- Medical
- Building automation
- HVAC air conditioning

### Electrical Data

	Silver	Gold
SWITCHING MODE:	BBM	BBM
MAX. SWITCHING POWER	5 VA	0.5 VA
MAX. SWITCHING CURRENT:	150 mA	20 mA
MAX. CARRYING CURRENT:	5 A	1 A
NOMINAL VOLTAGE AT 50 Hz	60 V	25 V
CONTACT RESISTANCE:	< 150 mΩ	< 150 mΩ
DIELECTRIC STRENGTH AT 50 Hz BETWEEN CONTACTS AND GROUND TERMINALS:	500 V r	500 V r
INSULATION RESISTANCE BETWEEN CONTACTS OR CONTACTS AND FRAME (500 V =):	10 <sup>9</sup> Ω	10 <sup>9</sup> Ω
NO. OF OPERATIONS:	10,000	10,000
BOUNCE:	< 5 ms	< 5 ms

### Mechanical Data

MAX. NO. OF BANKS: 1.  
 OPERATING TORQUE: 5 Ncm±20%.  
 END STOP TORQUE: < 60 Ncm.  
 STOP: With/without or adjustable  
 MOUNTING: By fixed index 9.5 mm (0.374) of center, for bushing mount only

### Materials

BUSHING/HOUSING: PETP Thermoplastic  
 STATIONARY CONTACTS & TERMINALS: Nickel Plated Brass with additional plating of Gold or Silver.  
 ROTOR: Gold or Silver plated Brass or PCB.  
 CODING PLATE: PA thermoplastic  
 ACTUATOR: Polysulfon thermoplastic  
 HARDWARE: Stop pin: Aluminum. Ball & Spring: Stainless steel. Washer: PA. Nut: Brass.

### Environmental Data

OPERATING TEMPERATURE: -20°C to + 70°C    -20°C to + 70°C  
 STORAGE TEMPERATURE: -40°C to + 85°C    -40°C to + 85°C

**NOTE:** Specifications and materials listed above are for switches with standard options. For information on specific and custom switches, consult Customer Service Center.

### Build-A-Switch

To order, simply select desired option from each category and place in the appropriate box. Available options are shown and described on pages K-9 thru K-12. For additional options not shown in catalog, consult Customer Service Center.



**Designation**  
**RTA**

**Indexing**  
**2** 22.5 index (coded only)  
**3** 30° index (12 positions max.)  
**4** 36° index (10 positions max.)

**Termination**  
**P** With PC Thru-hole  
**C** With Solder Lugs  
**H** Horizontal with PC Thru-hole

**Switch Function**  
**1W12** SP, 30° Index, 12 pos. no stop  
**1W10** SP, 36° Index, 10 pos. no stop  
**1S02** SP, 30° /36° Index, 2 pos.  
**1S03** SP, 30° /36° Index, 3 pos.  
**1S04** SP, 30° /36° Index, 4 pos.  
**1S05** SP, 30° /36° Index, 5 pos.  
**1S06** SP, 30° /36° Index, 6 pos.  
**1S07** SP, 30° /36° Index, 7 pos.  
**1S08** SP, 30° /36° Index, 8 pos.  
**1S09** SP, 30° /36° Index, 9 pos.  
**1S10** SP, 30° /36° Index, 10 pos.  
**1S11** SP, 30° Index, 11 pos.  
**1S12** SP, 30° Index, 12 pos.  
**2S02** DP, 30° /36° Index, 2 pos.  
**2S03** DP, 30° /36° Index, 3 pos.  
**2S04** DP, 30° /36° Index, 4 pos.  
**2S05** DP, 30° /36° Index, 5 pos.  
**2S06** DP, 30° Index, 6 pos.  
**3S02** 3P, 30° /36° Index, 2 pos.

**3S03** 3P, 30° /36° Index, 3 pos.  
**4S02** 4P, 30° /36° Index, 2 pos.  
**EW10** Direct + complement, 36° Index, no stop  
**EW12** Direct + complement, 30° Index, no stop  
**DW16** Direct, 22.5° Index, no stop  
**ES\_\_** Direct + complement, 30°/36° Index, with stop (specify stop position)  
**DS\_\_** Direct, 22.5° Index, with stop (specify stop position)

**Mounting Style**  
**W** Without bushing  
**R** 3/8-32 Threaded Bushing  
**M** M10x.75 Metric Threaded Bushing  
**A** 3/8-32 Threaded Bushing with Offset Bracket  
**B** M10x.75 Metric Threaded Bushing with Offset Bracket

**Contact Material**  
**S** Silver plated, matte-tin terminal  
**P** Gold plated, matte-tin terminal

**Actuator (max.)**  
**25N** .984 (25,0) with screwdriver slot  
**50N** 1.97 (50,0) with screwdriver slot  
**FLS** Flush shaft with screwdriver slot and position indicator  
**25F** .984 (25,0) Shaft with flat  
**06F** .236 (6,0) Shaft with flat

**C** 3/8-32 Threaded Bushing with Straight Bracket  
**D** M10x.75 Metric Threaded Bushing with Straight Bracket



Dimensions are shown: Inch (mm)  
 Specifications and dimensions subject to change

# RTA Series 1-4 Poles Coded Rotary Switches

## DESIGNATION



### RTA

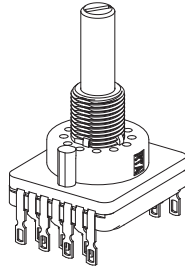

## TERMINATION



### P WITH PC PINS

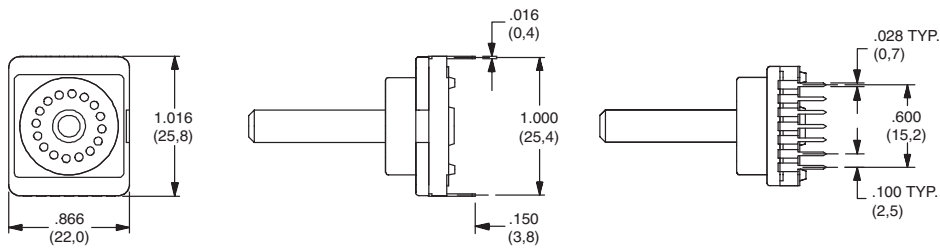

### C WITH SOLDER LUGS

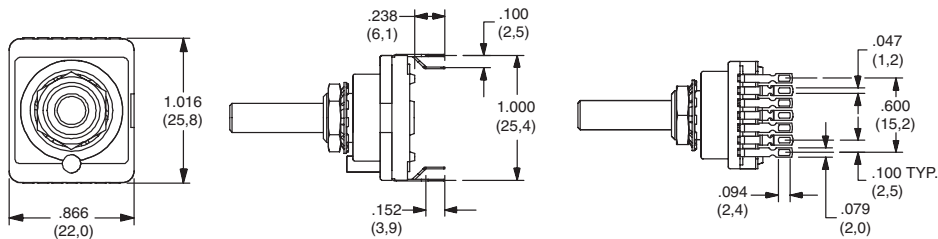

### H Horizontal with PC Thru-hole

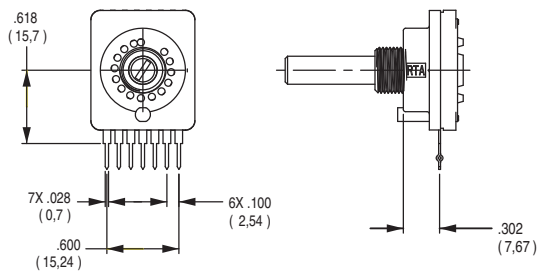

Note: "H" termination only available with the following options:  
 1. With A or B mounting styles  
 2. 36° degree indexing  
 3. Up to 5 positions max

## INDEXING

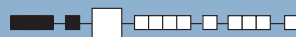

- 2** 22.5 index, 16 positions max.
- 3** 30 index, 12 positions max.
- 4** 36 index, 10 positions max.

Both commons must be connected by user to ground.

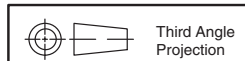

Dimensions are shown: mm  
 Specifications and dimensions subject to change

[www.ck-components.com](http://www.ck-components.com)



K

Rotary

# RTA Series 1-4 Poles Coded Rotary Switches

## SWITCH FUNCTION

NO. POLES	MODEL NO.	SWITCH FUNCTION	INDEX
SP	<b>1W12</b>	12 Positions No Stop	30°
	<b>1W10</b>	10 Positions No Stop	36°
	<b>1S02</b>	2 Positions	30°/36°
	<b>1S03</b>	3 Positions	30°/36°
	<b>1S05</b>	5 Positions	30°/36°
	<b>1S06</b>	6 Positions	30°/36°
	<b>1S08</b>	8 Positions	30°/36°
	<b>1S09</b>	9 Positions	30°/36°
	<b>1S10</b>	10 Positions	30°/36°
	<b>1S11</b>	11 Positions	30°
	<b>1S12</b>	12 Positions	30°

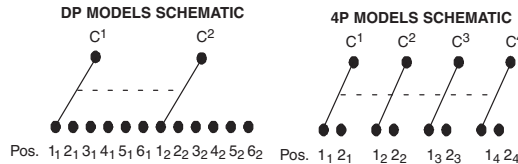
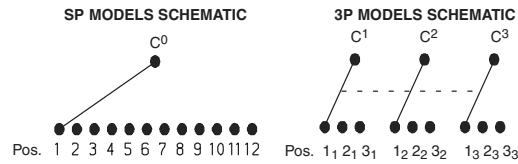

MODEL NO.	SWITCH FUNCTION	INDEX
<b>EW10</b>	Direct + complement, No stop	36°
<b>EW12</b>	Direct + complement, No stop	30°
<b>DW16</b>	Direct, No stop	22.5°
<b>ES__</b>	Direct + complement, with stop (specify stop position)	30° & 36°
<b>DS__</b>	Direct, with stop (specify stop position)	22.5°

NO. POLES	MODEL NO.	SWITCH FUNCTION	INDEX
DP	<b>2W05</b>	5 Positions No Stop	30°/36°
	<b>2W06</b>	6 Positions No Stop	30°
	<b>2S02</b>	2 Positions	30°/36°
	<b>2S03</b>	3 Positions	30°/36°
	<b>2S04</b>	4 Positions	30°/36°
	<b>2S05</b>	5 Positions	30°/36°
	<b>2S06</b>	6 Positions	30°
	3P	<b>3S02</b>	2 Positions
	<b>3S03</b>	3 Positions	30°/36°
4P	<b>4S02</b>	2 Positions	30°/36°

22.5°	30°	36°	Pos.																
Term.	Term.	Term.		1	2	3	4	5	6	7	8	9	10	11	12	13	14	15	16
E,J	M,N	L,N	C	•	•	•	•	•	•	•	•	•	•	•	•	•	•	•	•
F,I	H	D	1		•		•		•		•		•		•		•		•
D,K	D	B	2			•	•			•	•			•	•			•	•
A,N	A	I	4				•	•		•	•				•	•		•	•
B	J	J	8									•	•	•	•	•	•	•	•
-	C	K	1	•		•		•		•		•		•		•		•	
-	K	H	2	•	•			•	•			•	•		•	•			
-	B	A	4	•	•	•	•					•	•	•	•				
-	I	C	8	•	•	•	•	•	•	•	•								

### Indexing Option Code 2, 22.5 INDEXING ANGLE PCB LAYOUT

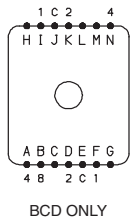

### Indexing Option Code 3, 30 INDEXING ANGLE PCB LAYOUT

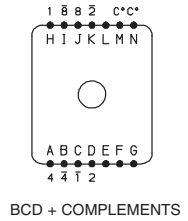
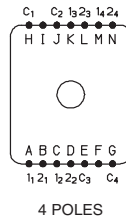
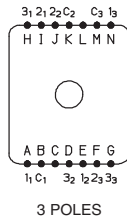
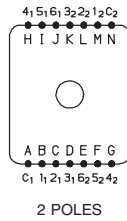
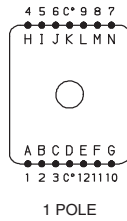

### Indexing Option Code 4, 36 INDEXING ANGLE PCB LAYOUT

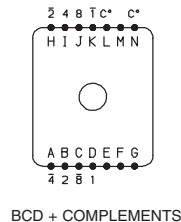
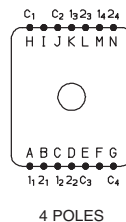
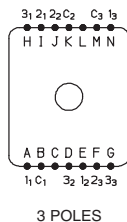
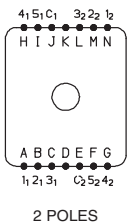
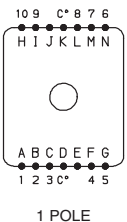

NOTE: Layout view from component side.

Common terminals that are in locations A-G are not connected to common terminals that are in locations H-N. For 7-12 position output customer must tie these commons together.



Dimensions are shown: Inch (mm)  
Specifications and dimensions subject to change



# RTA Series 1-4 Poles Coded Rotary Switches

## MOUNTING STYLE



### W WITHOUT BUSHING

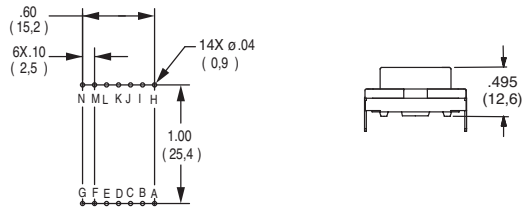

Note: W mounting style not available with H termination.

### M M10 x .75 METRIC THREADED BUSHING

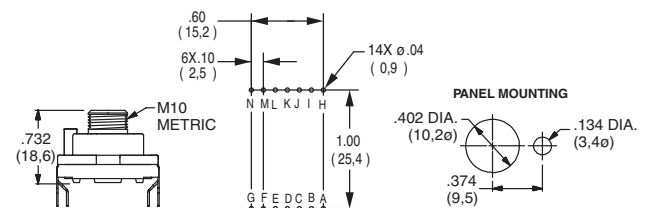

Note: M mounting style not available with H termination.

### R 3/8-32 THREADED BUSHING

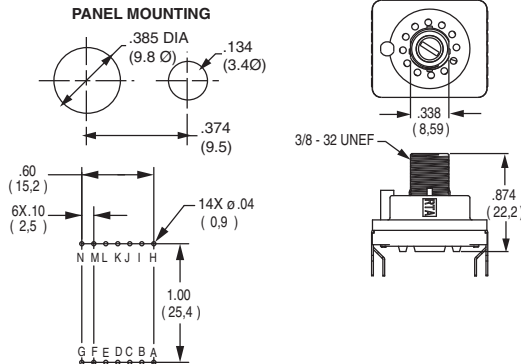

Note: R mounting style not available with H termination.

### A 3/8-32 THREADED BUSHING WITH BRACKET

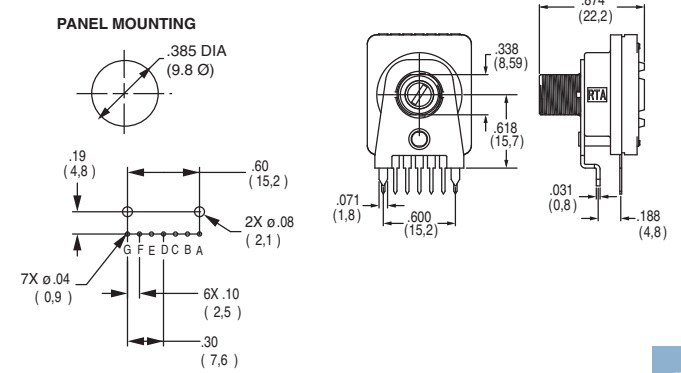

Note: A mounting style only available with H termination.

### B M10 x .75 METRIC THREADED BUSHING WITH BRACKET

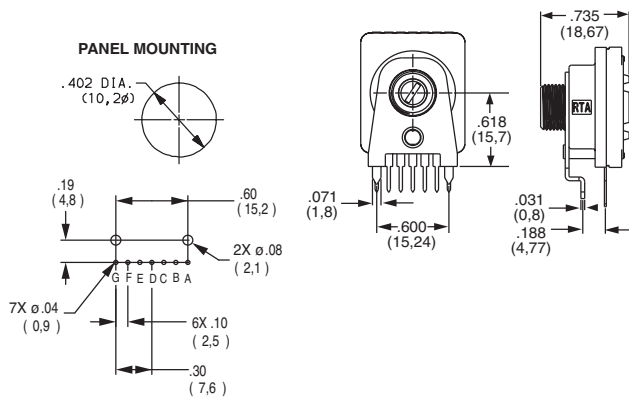

Note: B mounting style only available with H termination.

### C 3/8-32 THREADED BUSHING WITH STRAIGHT BRACKET

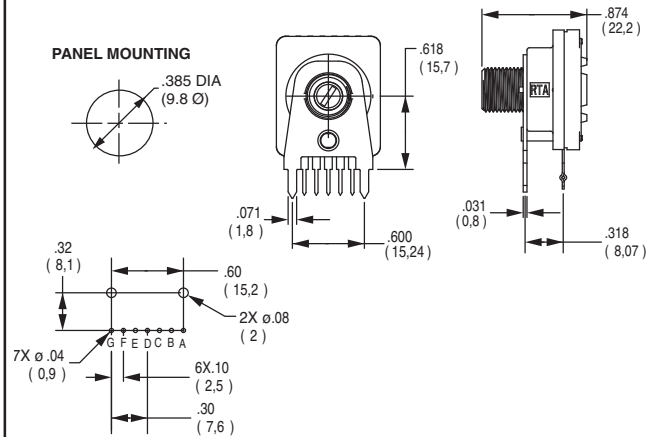

### D M10 x .75 METRIC THREADED BUSHING WITH STRAIGHT BRACKET

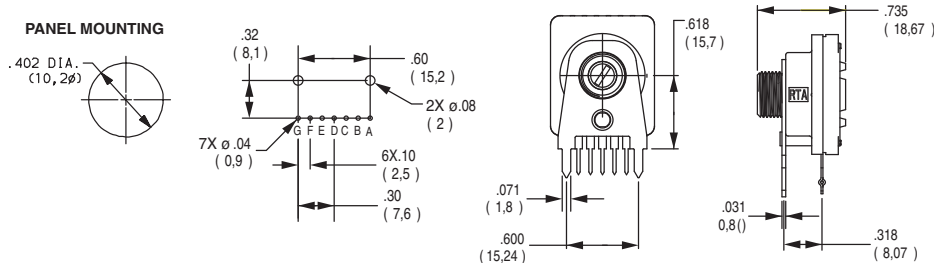

Third Angle Projection  
Dimensions are shown: mm  
Specifications and dimensions subject to change



K

Rotary

# RTA Series 1-4 Poles Coded Rotary Switches

## ACTUATOR

**25N** .984 (25,0) WITH SCREWDRIVER SLOT

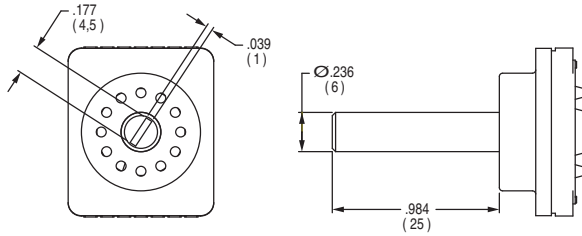

**50N** 1.97 (50,0) WITH SCREWDRIVER SLOT

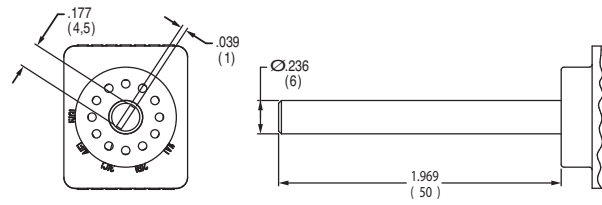

**FLS** FLUSH SHAFT WITH SCREWDRIVER SLOT AND POSITION INDICATOR

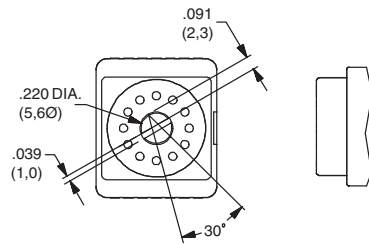

Note: only available with "W" Mounting Style

**25F** .984 (25,0) SHAFT WITH FLAT

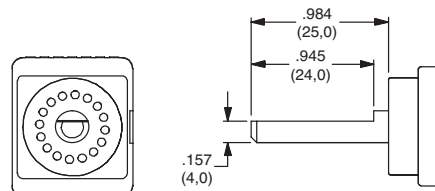

Note: only available with "W" Mounting Style

**06F** .236 (6,0) SHAFT WITH FLAT

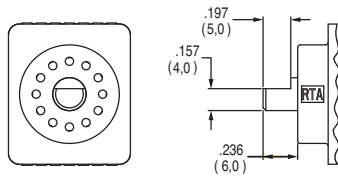

Note: only available with "W" Mounting Style

## CONTACT MATERIAL

OPTION CODE	CONTACT AND TERMINAL MATERIAL	RATING	
		<b>S</b>	SILVER
<b>P</b>	GOLD	LOW LEVEL/DRY CIRCUIT OR POWER	SWITCH: 20 mA MAXIMUM, 25 V NOMINAL. POWER: 0.5 VA MAXIMUM. CARRY: 1 AMP MAXIMUM.

\* Note: See Technical Data section of this catalog for RoHS compliant and compatible definition and specifications.

## AVAILABLE HARDWARE

### Mounting Nuts

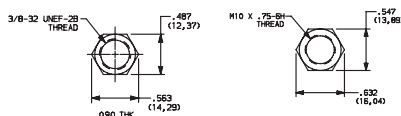

PART NO.  
**472706201**  
Standard

PART NO.  
**495100201**  
Metric

### Stop pins



PART NO.  
**Y200300200P**

### Lockwasher

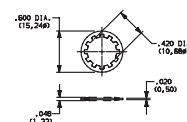

PART NO.  
**472800202**

NOTE: Additional nuts and lockwashers available separately, see section "Technical Data and Additional Hardware".

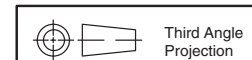

Dimensions are shown: Inch (mm)  
Specifications and dimensions subject to change

