

# CA Series Illuminated Power Rocker Switches

## Features/Benefits

- 15 AMPS @ 125 V AC
- Illuminated actuator
- Various actuator styles

## Typical Applications

- Power outlet strips
- Appliances
- Handling and packaging machines
- RoHS compliant



Models Available

## Specifications

CONTACT RATING: 15 AMPS @ 125 V AC; 10 AMPS @ 250 V AC; 1/4 HP @ 125 V AC or 250 V AC 

ELECTRICAL LIFE: 10,000 make-and-break cycles at full load.

LAMP LIFE: 20,000 hours typ.

INSULATION RESISTANCE:  $10^9 \Omega$  min.

DIELECTRIC STRENGTH: 1,000 Vrms min. @ sea level.

## Materials

HOUSING: 6/6 nylon (UL 94V-2), black.

ACTUATOR: Polycarbonate (UL 94V-2), red.

CONTACTS: Coin silver, silver plated.

OPERATING TEMPERATURE: -30°C to +85°C

**NOTE:** Specifications and materials listed above are for switches with standard options. For information on specific and custom switches, consult Customer Service Center.

## Build-A-Switch

To order, simply select desired option from each category and place in the appropriate box. Available options are shown and described on pages G-110 through G-112. For additional options not shown in catalog, consult Customer Service Center.

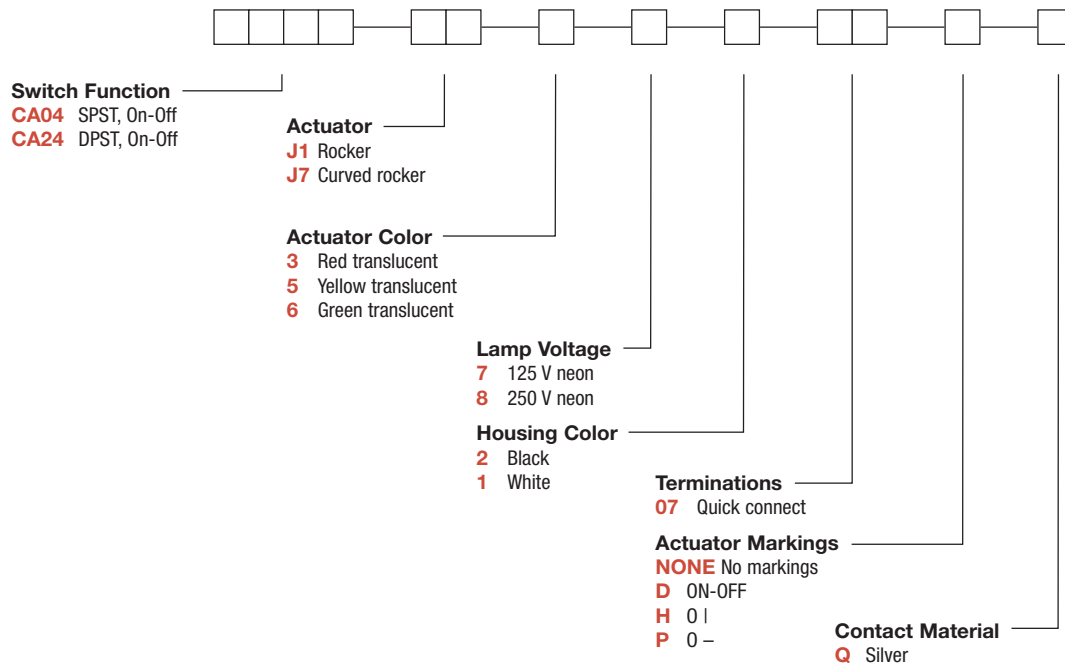

Rocker



Dimensions are shown: Inches (mm)  
Specifications and dimensions subject to change

www.ck-components.com

# CA Series Illuminated Power Rocker Switches

## SWITCH FUNCTION

NO. POLES	MODEL NO.	SWITCH FUNCTION		CONNECTED TERMINALS		SCHEMATIC
		POS. 1	POS. 2	POS. 1	POS. 2	
SP	<b>CA04</b>	ON	OFF	1-1A	OPEN	
<p><b>SPST</b></p> <p>Part number shown: CA04J137207Q</p> <p>ACTUATOR SHOWN IN POS. 1 - 'ON' POSITION</p> <p>TERMINAL NOS. MARKED ON HOUSING</p>						
DP	<b>CA24</b>	ON	OFF	1-1A, 2-2A	OPEN	
<p><b>DPST</b></p> <p>Part number shown: CA24J137207Q</p> <p>ACTUATOR SHOWN IN POS. 1 - 'ON' POSITION</p> <p>TERMINAL NOS. MARKED ON HOUSING</p>						

See CONTACT MATERIAL section, page G-112, for complete contact ratings and agency approvals.  
 Contacts make on side opposite actuator thrown.  
 All models with all options.

Rocker

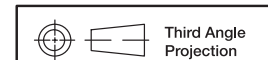

Dimensions are shown: Inches (mm)  
 Specifications and dimensions subject to change

[www.ck-components.com](http://www.ck-components.com)

# CA Series Illuminated Power Rocker Switches

## ACTUATOR

### J1 ROCKER

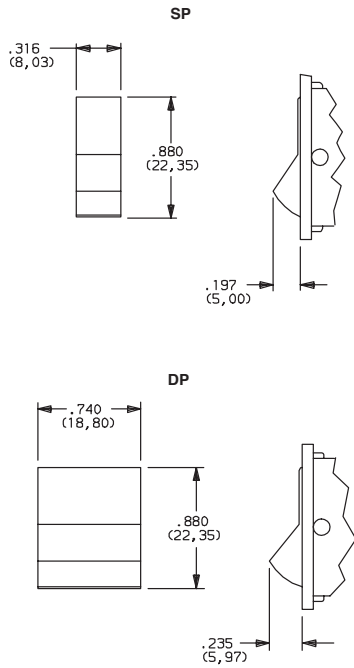

### J7 CURVED ROCKER

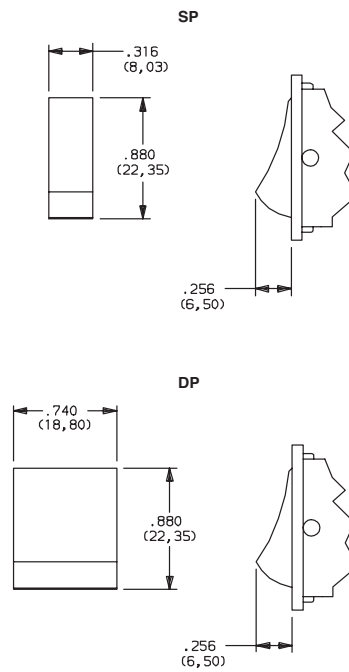

## ACTUATOR COLOR

OPTION CODE	ACTUATOR COLOR
3	RED TRANSLUCENT
5	YELLOW
6	GREEN

**NOTE:** Special colors available, consult Customer Service Center.

## NEON LAMP VOLTAGE

- 7 125 V NEON
- 8 250 V NEON

## HOUSING COLOR

OPTION CODE	HOUSING COLOR
2	BLACK
1	WHITE

**NOTE:** Housing frame finish: matte. Special colors available, consult Customer Service Center.

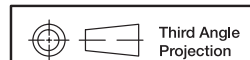

Third Angle Projection

Dimensions are shown: Inches (mm)  
Specifications and dimensions subject to change

www.ck-components.com



# CA Series Illuminated Power Rocker Switches

## TERMINATIONS

### 07 QUICK CONNECT

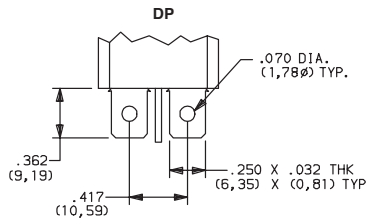
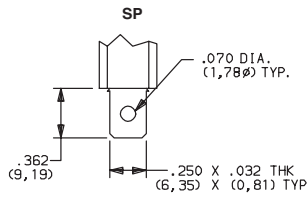

### PANEL MOUNTING

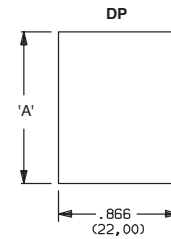
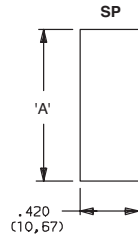

PANEL THICKNESS	DIM 'A'
.059-.078 (1,50) (2,00)	1.102 (28,00)
.078-.118 (2,00) (3,00)	1.110 (28,20)
.118-.177 (3,00) (4,50)	1.126 (28,60)

## ACTUATOR MARKINGS

**NONE** NO MARKING

**D** ON-OFF

**H** O I

**P** O -

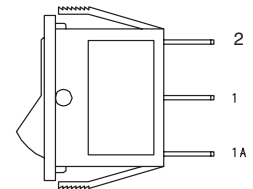
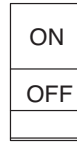
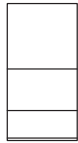

Marking color white, standard for all actuator colors except yellow. Marking color black, standard for yellow actuators. Consult Customer Service Center for other available markings and colors.

**NOTE:** Orientation of actuator markings and terminals

## CONTACT MATERIAL

OPTION CODE	CONTACT AND TERMINAL MATERIAL	RATINGS	
<b>Q</b>	SILVER <sup>1</sup>	POWER	15 AMPS @ 125 V AC; 10 AMPS @ 250 V AC; 1/4 HP @ 125 V AC or 250 V AC (UL/CSA).

\* Note: See Technical Data section of this catalog for RoHS compliant and compatible definitions and specifications.

<sup>1</sup> CONTACTS: Coin silver, silver plated.  
TERMINALS: Copper, silver plated.

All models with all options.

Rocker



G

**C&K**

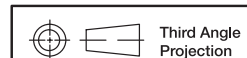

Dimensions are shown: Inches (mm)  
Specifications and dimensions subject to change

[www.ck-components.com](http://www.ck-components.com)