

# Smart Lowside Power Switch

## Features

- Logic Level Input
- Input Protection (ESD)
- Thermal shutdown with latch
- Overload protection
- Short circuit protection
- Overvoltage protection
- Current limitation
- Status feedback with external input resistor
- Analog driving possible

## Product Summary

Drain source voltage	$V_{DS}$	60	V
On-state resistance	$R_{DS(on)}$	50	mΩ
Current limit	$I_{D(lim)}$	21	A
Nominal load current	$I_{D(ISO)}$	7	A
Clamping energy	$E_{AS}$	2000	mJ

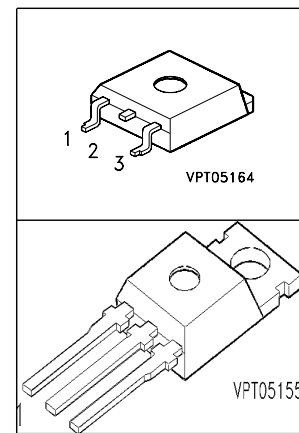

## Application

- All kinds of resistive, inductive and capacitive loads in switching or linear applications
- μC compatible power switch for 12 V and 24 V DC applications
- Replaces electromechanical relays and discrete circuits

## General Description

N channel vertical power FET in Smart SIPMOS® chip on chip technology. Fully protected by embedded protected functions.

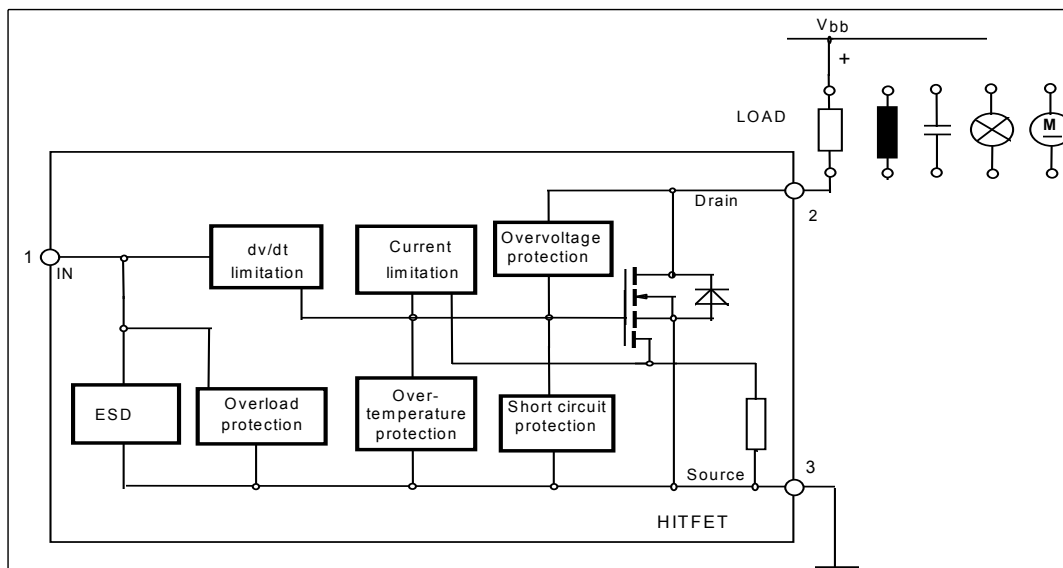

**Maximum Ratings at T<sub>j</sub> = 25 °C unless otherwise specified**

Parameter	Symbol	Value	Unit
Drain source voltage	V <sub>DS</sub>	60	V
Drain source voltage for short circuit protection	V <sub>DS(SC)</sub>	32	
Continuous input current <sup>1)</sup> -0.2V ≤ V <sub>IN</sub> ≤ 10V V <sub>IN</sub> < -0.2V or V <sub>IN</sub> > 10V	I <sub>IN</sub>	no limit   I <sub>IN</sub>   ≤ 2	mA
Operating temperature	T <sub>j</sub>	- 40 ... +150	°C
Storage temperature	T <sub>stg</sub>	- 55 ... +150	
Power dissipation T <sub>C</sub> = 25 °C	P <sub>tot</sub>	90	W
Unclamped single pulse inductive energy I <sub>D(ISO)</sub> = 7 A	E <sub>AS</sub>	2000	mJ
Electrostatic discharge voltage (Human Body Model) according to MIL STD 883D, method 3015.7 and EOS/ESD assn. standard S5.1 - 1993	V <sub>ESD</sub>	3000	V
Load dump protection V <sub>LoadDump</sub> <sup>2)</sup> = V <sub>A</sub> + V <sub>S</sub> V <sub>IN</sub> =low or high; V <sub>A</sub> =13.5 V t <sub>d</sub> = 400 ms, R <sub>I</sub> = 2 Ω, I <sub>D</sub> =0,5*7A t <sub>d</sub> = 400 ms, R <sub>I</sub> = 2 Ω, I <sub>D</sub> = 7A	V <sub>LD</sub>	90 74	
DIN humidity category, DIN 40 040		E	
IEC climatic category; DIN IEC 68-1		40/150/56	

**Thermal resistance**

junction - case:	R <sub>thJC</sub>	1.4	K/W
junction - ambient:	R <sub>thJA</sub>	75	
SMD version, device on PCB: <sup>3)</sup>	R <sub>thJA</sub>	45	

<sup>1)</sup>In case of thermal shutdown a minimum sensor holding current of 500 μA has to be guaranteed (see also page 3).

<sup>2)</sup>V<sub>LoadDump</sub> is setup without the DUT connected to the generator per ISO 7637-1 and DIN 40839

<sup>3)</sup> Device on 50mm\*50mm\*1.5mm epoxy PCB FR4 with 6cm<sup>2</sup> (one layer, 70μm thick) copper area for Drain connection. PCB mounted vertical without blown air.

**Electrical Characteristics**

Parameter at $T_j=25^\circ\text{C}$ , unless otherwise specified	Symbol	Values			Unit
		min.	typ.	max.	
<b>Characteristics</b>					
Drain source clamp voltage $T_j = -40 \dots +150^\circ\text{C}$ , $I_D = 10 \text{ mA}$	$V_{DS(AZ)}$	60	-	73	V
Off state drain current $V_{DS} = 32 \text{ V}$ , $T_j = -40\dots+150^\circ\text{C}$ , $V_{IN} = 0 \text{ V}$	$I_{DSS}$	-	-	10	$\mu\text{A}$
Input threshold voltage $I_D = 1,4 \text{ mA}$	$V_{IN(th)}$	1.3	1.7	2.2	V
Input current - normal operation, $I_D < I_{D(lim)}$ : $V_{IN} = 10 \text{ V}$	$I_{IN(1)}$	-	30	55	$\mu\text{A}$
Input current - current limitation mode, $I_D = I_{D(lim)}$ : $V_{IN} = 10 \text{ V}$	$I_{IN(2)}$	60	150	350	
Input current - after thermal shutdown, $I_D = 0 \text{ A}$ : $V_{IN} = 10 \text{ V}$	$I_{IN(3)}$	1000	2500	4000	
Input holding current after thermal shutdown <sup>1)</sup> $T_j = 25^\circ\text{C}$ $T_j = 150^\circ\text{C}$	$I_{IN(H)}$	500 300	- -	- -	
On-state resistance $V_{IN} = 5 \text{ V}$ , $I_D = 7 \text{ A}$ , $T_j = 25^\circ\text{C}$ $V_{IN} = 5 \text{ V}$ , $I_D = 7 \text{ A}$ , $T_j = 150^\circ\text{C}$	$R_{DS(on)}$	- -	50 90	60 120	$\text{m}\Omega$
On-state resistance $V_{IN} = 10 \text{ V}$ , $I_D = 7 \text{ A}$ , $T_j = 25^\circ\text{C}$ $V_{IN} = 10 \text{ V}$ , $I_D = 7 \text{ A}$ , $T_j = 150^\circ\text{C}$	$R_{DS(on)}$	- -	40 75	50 100	
Nominal load current (ISO 10483) $V_{IN} = 10 \text{ V}$ , $V_{DS} = 0.5 \text{ V}$ , $T_C = 85^\circ\text{C}$	$I_{D(ISO)}$	7	-	-	A

<sup>1)</sup>If the input current is limited by external components, low drain currents can flow and heat the device. Auto restart behaviour can occur.

**Electrical Characteristics**

Parameter at $T_j=25^\circ\text{C}$ , unless otherwise specified	Symbol	Values			Unit
		min.	typ.	max.	

**Characteristics**

Initial peak short circuit current limit $V_{IN} = 10\text{ V}$ , $V_{DS} = 12\text{ V}$	$I_{D(SCp)}$	-	65	-	A
Current limit <sup>1)</sup> $V_{IN} = 10\text{ V}$ , $V_{DS} = 12\text{ V}$ , $t_m = 350\ \mu\text{s}$ , $T_j = -40\dots+150\ ^\circ\text{C}$	$I_{D(lim)}$	21	28	40	

**Dynamic Characteristics**

Turn-on time $V_{IN}$ to 90% $I_D$ : $R_L = 2,2\ \Omega$ , $V_{IN} = 0$ to $10\text{ V}$ , $V_{bb} = 12\text{ V}$	$t_{on}$	--	40	100	$\mu\text{s}$
Turn-off time $V_{IN}$ to 10% $I_D$ : $R_L = 2,2\ \Omega$ , $V_{IN} = 10$ to $0\text{ V}$ , $V_{bb} = 12\text{ V}$	$t_{off}$	--	70	170	
Slew rate on 70 to 50% $V_{bb}$ : $R_L = 2,2\ \Omega$ , $V_{IN} = 0$ to $10\text{ V}$ , $V_{bb} = 12\text{ V}$	$-dV_{DS}/dt_{on}$	--	1	3	V/ $\mu\text{s}$
Slew rate off 50 to 70% $V_{bb}$ : $R_L = 2,2\ \Omega$ , $V_{IN} = 10$ to $0\text{ V}$ , $V_{bb} = 12\text{ V}$	$dV_{DS}/dt_{off}$	--	1	3	

**Protection Functions**

Thermal overload trip temperature	$T_{jt}$	150	165	-	$^\circ\text{C}$
Unclamped single pulse inductive energy $I_D = 7\text{ A}$ , $T_j = 25\ ^\circ\text{C}$ , $V_{bb} = 32\text{ V}$ $I_D = 7\text{ A}$ , $T_j = 150\ ^\circ\text{C}$ , $V_{bb} = 32\text{ V}$	$E_{AS}$	2000 450	- -	- -	mJ

**Inverse Diode**

Inverse diode forward voltage $I_F = 5 \cdot 7\text{ A}$ , $t_m = 300\ \mu\text{s}$ , $V_{IN} = 0\text{ V}$	$V_{SD}$	-	1.08	-	V
--	----------	---	------	---	---

<sup>1)</sup>Device switched on into existing short circuit (see diagram Determination of  $I_{D(lim)}$ ). If the device is in on condition and a short circuit occurs, these values might be exceeded for max. 50  $\mu\text{s}$ .

## Block Diagramm

### Terms

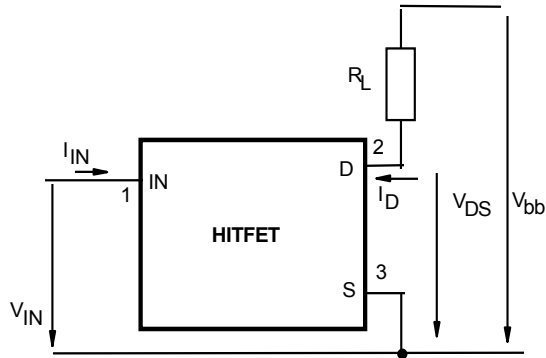

### Inductive and overvoltage output clamp

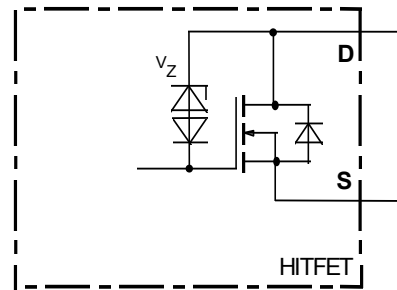

### Input circuit (ESD protection)

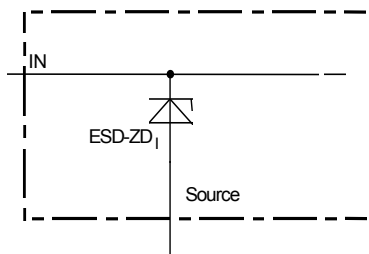

ESD zener diodes are not designed for DC current  $> 2 \text{ mA}$  @  $V_{IN} > 10\text{V}$ .

### Short circuit behaviour

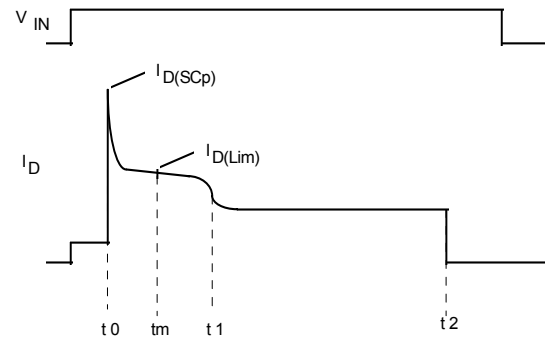

- $t_0$ : Turn on into a short circuit
- $t_m$ : Measurementpoint for  $I_{D(lim)}$
- $t_1$ : Activation of the fast temperature sensor and regulation of the drain current to a level where the junction temperature remains constant.
- $t_2$ : Thermal shutdown caused by the second temperature sensor, achieved by an integrating measurement.

**Maximum allowable power dissipation**

$P_{tot} = f(T_c)$

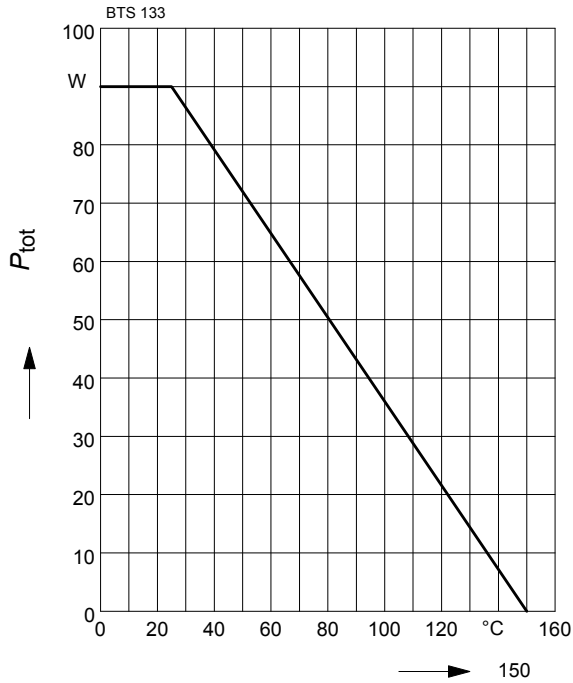

**On-state resistance**

$R_{ON} = f(T_j); I_D=7A; V_{IN}=10V$

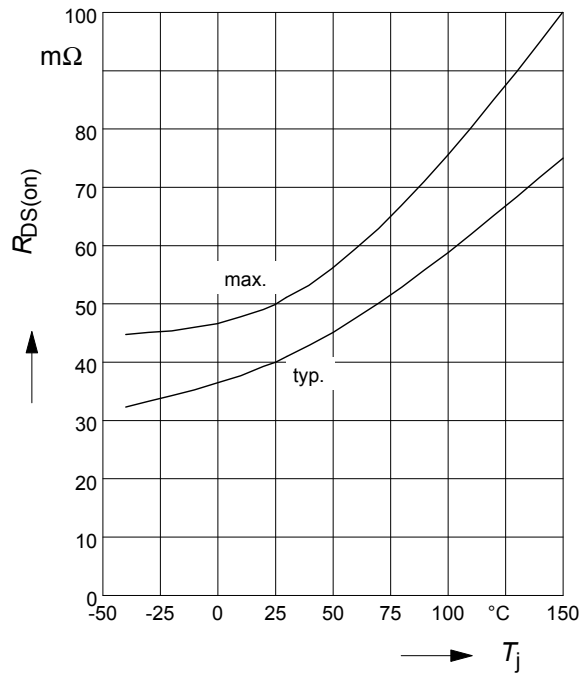

**On-state resistance**

$R_{ON} = f(T_j); I_D=7A; V_{IN}=5V$

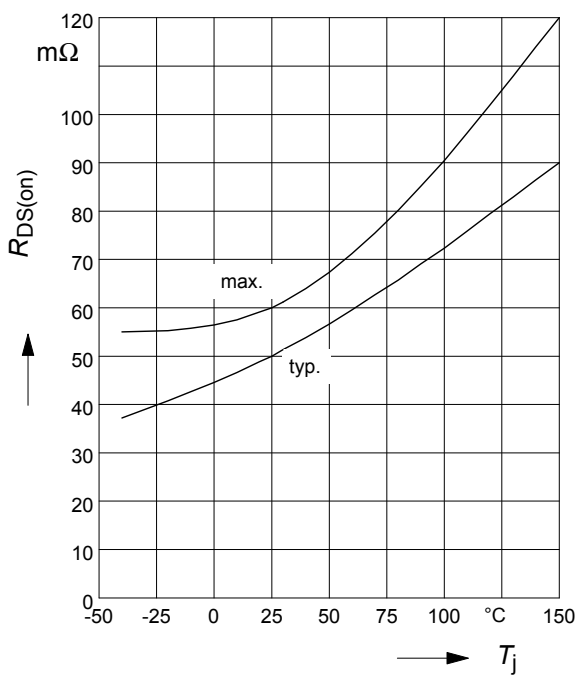

**Typ. input threshold voltage**

$V_{IN(th)} = f(T_j); I_D=1,4mA; V_{DS}=12V$

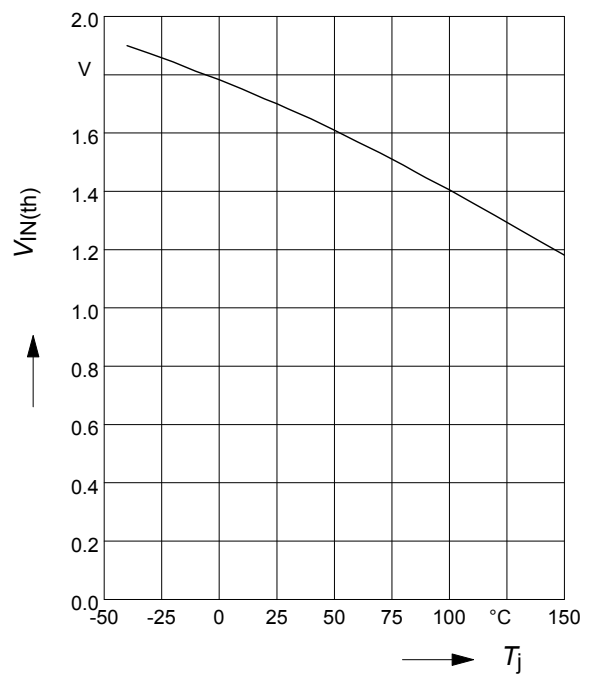

**Typ. transfer characteristics**

$I_D = f(V_{IN}); V_{DS}=12V; T_j=25^\circ C$

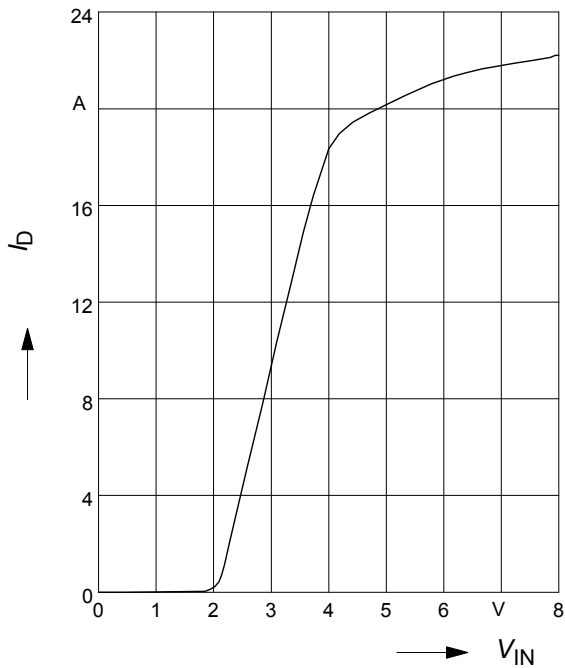

**Typ. output characteristic**

$I_D = f(V_{DS}); T_j=25^\circ C$

Parameter:  $V_{IN}$

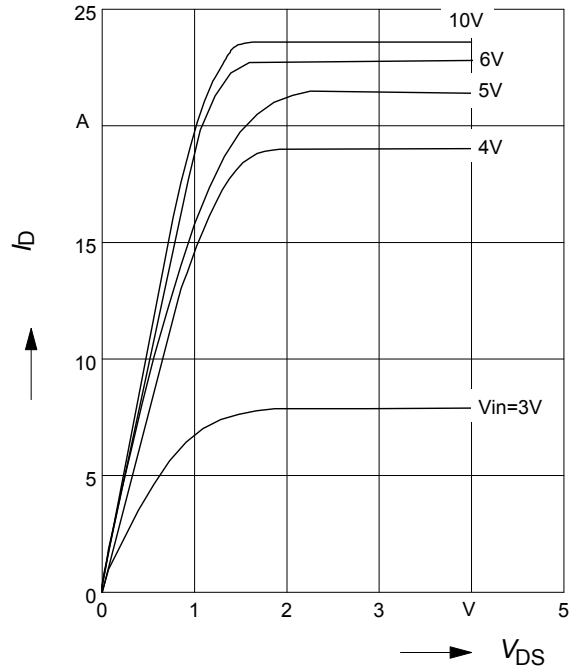

**Transient thermal impedance**

$Z_{thJC} = f(t_p)$

parameter :  $D = t_p/T$

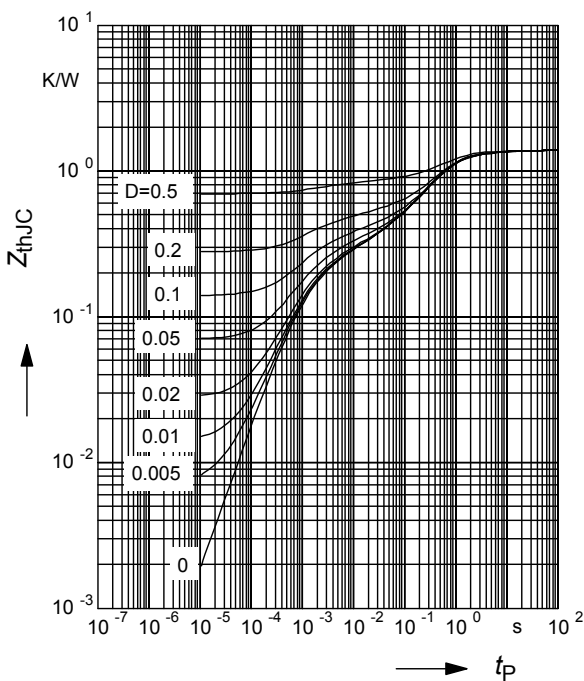

**Application examples:**

**Status signal of thermal shutdown by monitoring input current**

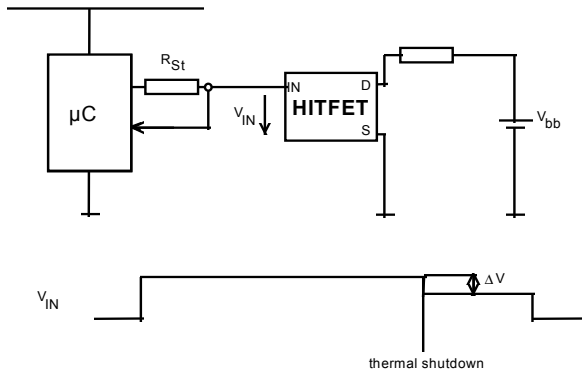

$$\Delta V = R_{ST} * I_{IN(3)}$$

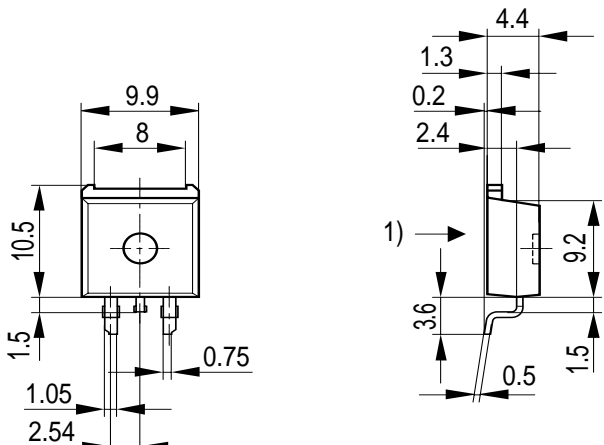
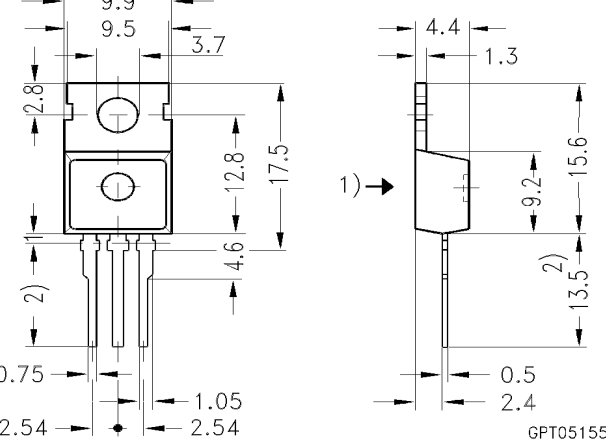

Package	Ordering Code	Package	Ordering Code
P-TO220-3-45	Q67060-S6501-A3	P-TO220-3-1	Q67060-S6501-A2
			
1) shear and punch direction no burrs this surface		1) punch direction, burr max. 0.04 2) dip tinning 3) max. 14.5 by dip tinning press burr max. 0.05	

**Published by**  
**Infineon Technologies AG,**  
**Bereichs Kommunikation**  
**St.-Martin-Strasse 53,**  
**D-81541 München**  
 © Infineon Technologies AG 1999  
**All Rights Reserved.**

**Attention please!**

The information herein is given to describe certain components and shall not be considered as warranted characteristics.

Terms of delivery and rights to technical change reserved.

We hereby disclaim any and all warranties, including but not limited to warranties of non-infringement, regarding circuits, descriptions and charts stated herein.

Infineon Technologies is an approved CECC manufacturer.

**Information**

For further information on technology, delivery terms and conditions and prices please contact your nearest Infineon Technologies Office in Germany or our Infineon Technologies Representatives worldwide (see address list).

**Warnings**

Due to technical requirements components may contain dangerous substances.

For information on the types in question please contact your nearest Infineon Technologies Office.

Infineon Technologies Components may only be used in life-support devices or systems with the express written approval of Infineon Technologies, if a failure of such components can reasonably be expected to cause the failure of that life-support device or system, or to affect the safety or effectiveness of that device or system. Life support devices or systems are intended to be implanted in the human body, or to support and/or maintain and sustain and/or protect human life. If they fail, it is reasonable to assume that the health of the user or other persons may be endangered.