

(MIL Qualified)

Material and Finish

Shell — Steel, cadmium plated

Insert — Approved material per MIL-DTL-24308

Retention Clips — Stainless steel or copper alloy

(Industrial Grade)

Material and Finish

Shell — Steel, zinc plated

Insert — Polyphenylene Sulfide (PPS)

Retention Clips — Stainless steel or copper alloy

Related Product Data

Cavity Identification — page 5127

Contacts — pages 5128, 5129

Mounting, Mating Dimensions — page 5143

Accessories — pages 5148-5150

Attention: Connector marking

Connector marking may differ from package marking. All connectors marked per MIL-DTL-24308.

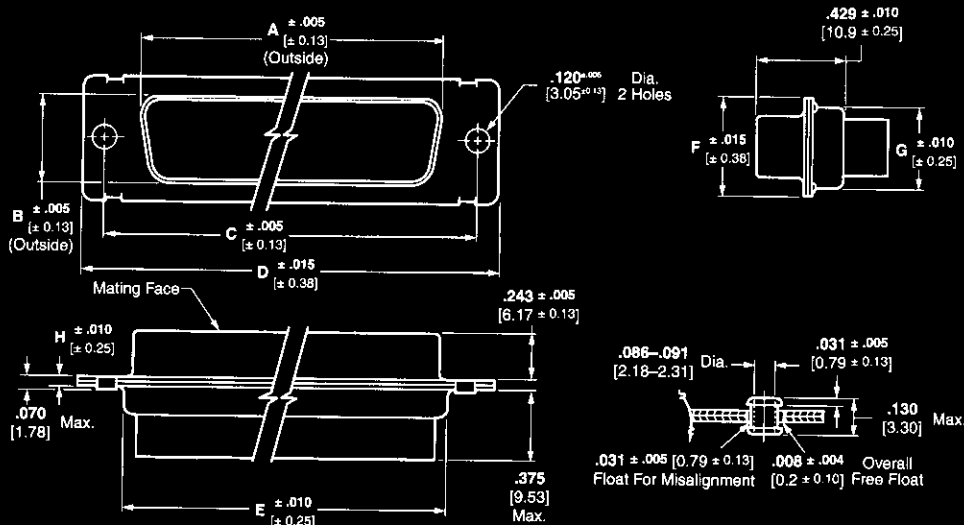

Floating Bushing Dual Mount

Clinch Nut Mount

Pin and Socket Connectors

No. of Contact Pos. (Shell Size)	Dimensions								MIL Qualified				Description	Industrial Grade ³ Clinch Nut Mount Part No.
	A	B	C	D	E	F	G	H	Standard Mount		Floating Bushing Mount			
	Military Part No. ² M24308/	AMP Part No.	Military Part No. M24308/	AMP Part No.	Military Part No. M24308/	AMP Part No.	Military Part No. M24308/	AMP Part No.	Military Part No. M24308/	AMP Part No.	Military Part No. M24308/	AMP Part No.		
15 (1)	.643 [16.33]	.311 [7.9]	.984 [24.99]	1.213 [30.81]	.759 [19.28]	.494 [12.55]	.422 [10.72]	.030 [0.76]	2-286F	204500-1	2-297F	204524-1	Recept. only	1218747-1
26 (2)	.971 [24.66]	.311 [7.9]	1.312 [33.32]	1.541 [39.14]	1.083 [27.51]	.494 [12.55]	.422 [10.72]	.030 [0.76]	2-287F	204502-1	2-298F	204526-1	Recept. only	1218747-2
44 (3)	1.511 [38.38]	.311 [7.9]	1.852 [47.04]	2.088 [53.04]	1.625 [41.3]	.494 [12.55]	.422 [10.72]	.039 [0.99]	2-288F	204504-1	2-299F	204528-1	Recept. only	1218747-3
62 (4)	2.159 [54.84]	.311 [7.9]	2.500 [63.5]	2.729 [69.32]	2.272 [57.7]	.494 [12.55]	.422 [10.72]	.039 [0.99]	2-289F	204506-1	2-300F	204530-1	Recept. only	1218747-4
78 (5)	2.064 [52.43]	.423 [10.74]	2.406 [61.11]	2.635 [66.93]	2.178 [55.32]	.605 [15.37]	.534 [13.56]	.039 [0.99]	2-290F	204508-1	2-301F	204532-1	Recept. only	1218747-5
104 (6)	2.189 [55.6]	.485 [12.32]	2.500 [63.5]	2.729 [69.32]	2.302 [58.47]	.668 [16.97]	.596 [15.14]	.039 [0.99]	2-291F	204510-1	2-302F	204534-1	Recept. only	1218747-6
									2-16F	204522-2	2-33F	204546-2	Recept. with sockets ¹	—

Notes: See pages 5151 through 5155 (military to AMP Part Number cross reference) for additional part numbers.
¹ Size 22 sockets supplied with receptacles are loose piece.
² "F" is stamped on connectors following M24308 part number as required. "F" designates cadmium shell plating.
³ Meets requirements of MIL-DTL-24308.