

1. INTRODUCTION

The CERTI-CRIMP II Straight Action Hand Tools are designed to crimp a variety of loose piece terminals.

NOTE

Refer to <http://tooling.tycoelectronics.com> "Documentation" - "CERTI-CRIMP Data Sheets" for a list of loose piece terminals that may be crimped by the CERTI-CRIMP II Straight Action Hand Tool. **The website also contains instructions in various languages.**

CAUTION

The wire crimper bottoms against the anvil before the ratchet releases. This is a design feature that assures maximum electrical and tensile performance of the crimp. Do NOT re-adjust the ratchet.

简介

CERTI-CRIMP II 直动式手工具用于压接多种散装端子。

注意：请登录 <http://tooling.tycoelectronics.com> "Documentation" - "CERTI-CRIMP Data Sheets" 网站以获取可由 CERTI-CRIMP II 直动式手工具压接的端子列表。

注意：在 CERTI-CRIMP 棘轮释放前，其压线刀下行至贴住底刀的位置。此设计用于确保压接后能得到最大的电气及拉力性能。棘轮位置不允许调整。

1. INTRODUCTION

Les pinces à action directe CERTI-CRIMP II permettent de sertir différents types de cosses en vrac.

REMARQUE

La liste complète des cosses en vrac sertissables à l'aide de la pince à action directe CERTI-CRIMP II est consultable sur le site <http://tooling.tycoelectronics.com> "Documentation" - "CERTI-CRIMP Data Sheets" Ce site comporte également des instructions dans différentes langues.

ATTENTION

Le poinçon du fil vient en butée contre l'enclume avant le déblocage de la crémaillère CERTI-CRIMP. Cette fonctionnalité permet d'assurer des performances de sertissage optimales tant sur le plan électrique que sur celui de la tenue en traction du fil. NE PAS retoucher au réglage de la crémaillère.

1. はじめに

CERTI-CRIMP II ストレートアクション・ハンドツールは、様々なバラ状端子の圧着用に設計されています。

注 記

それぞれの CERTI-CRIMP II ストレートアクション・ハンドツールで圧着できる端子のリストは、<http://tooling.tycoelectronics.com> "Documentation" - "CERTI-CRIMP Data Sheets" でご覧になれます。また、このウェブサイトでは各国の言語に翻訳されているこの取扱説明書をご覧になれます。

注 意

ツールのラチェットが解除される前に、ワイヤークリムパーがアンビルに突き当たります。この方式により、圧着の電気的および機械的性能を最大限に引き出します。お客様でのラチェットの再調整は、絶対にしないでください。

1. EINFÜHRUNG

Die CERTI-CRIMP II Handzange ist dazu vorgesehen, unterschiedliche Klemmen zu crimpen.

ANMERKUNG

Siehe <http://tooling.tycoelectronics.com> "Documentation" - "CERTI-CRIMP Data Sheets" für eine Aufstellung von LP-Kontakte, die mit der CERTI-CRIMP Handzange gecrimpt werden können. Die Website enthält auch Anleitungen in verschiedenen Sprachen.

VORSICHT

Das Werkzeugoberteil fährt immer auf Block mit den Amboß, bevor die CERTI-CRIMP Handzange die Ratsche freigibt. Dies ist ein Konstruktionsmerkmal, welches maximale Verpressung und Zugfestigkeit des Crimp-Kontaktes gewährleistet. Die Ratsche darf nicht verstellt werden.

1. INTRODUZIONE

Gli attrezzi manuali CERTI-CRIMP II Straight Action sono progettati per aggraffare vari tipi di terminali sciolti.

NOTA

Per la lista dei terminali sciolti che possono essere aggraffati con l'attrezzo manuale CERTI-CRIMP II Straight Action, consultare il sito multilingua <http://tooling.tycoelectronics.com> "Documentation" - "CERTI-CRIMP Data Sheets".

ATTENZIONE

Prima del rilascio del cricchetto, la matrice di aggraffatura è appoggiata sull'incudine. Tale condizione garantisce prestazioni ottimali dell'aggraffatura in termini di elettricità e tensione. NON modificare la regolazione del cricchetto.

PROPER USE GUIDELINES

Cumulative Trauma Disorders can result from the prolonged use of manually powered hand tools. Hand tools are intended for occasional use and low volume applications. A wide selection of powered application equipment for extended-use, production operations is available.

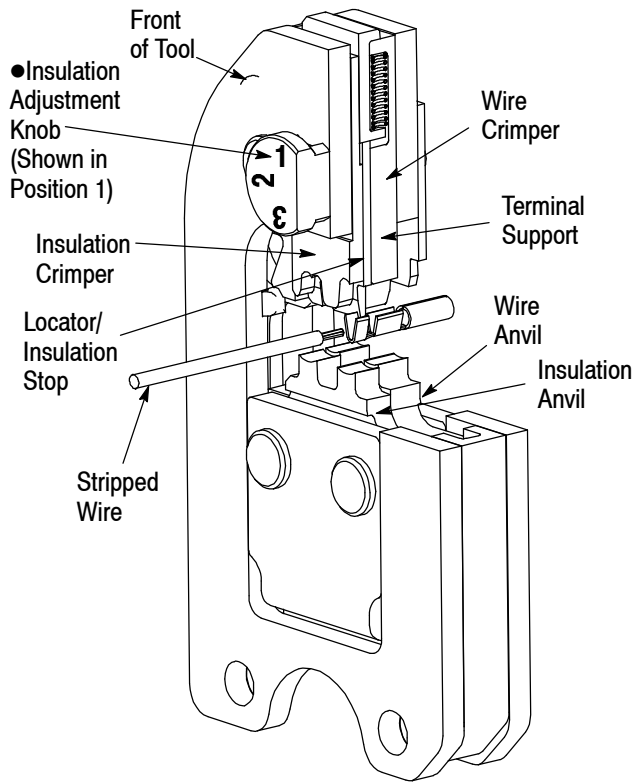

●**NOTE:** Some tools do not have insulation adjustment knobs. These tools are fixed at one position with a spring pin.

Figure 1

2. DESCRIPTION

The FRONT of the tool, is marked with the tool part number, wire size ranges, and crimp height specifications.

The tool features a fixed die (crimper), a movable die (anvil), a locator/insulation stop, and a ratchet. Many tools feature an insulation adjustment knob which is used to regulate the crimp height of the contact insulation barrel during the crimping operation. The locator/insulation stop positions the contact, and limits the insertion distance of the stripped wire into the contact. In use, the locator/insulation stop rests in the locator slot of the contact (See Figures 1 and 2). The ratchet assures full crimping of the contact. Once

engaged, the ratchet will not release until the dies have been fully closed.

3. CRIMPING PROCEDURE

Refer to the table at <http://tooling.tycoelectronics.com> to ensure that the wire intended for use is compatible with the wire size and insulation diameter specified in the table. Strip the wire to the length indicated in the table.

CAUTION

Do NOT cut or nick the wire strands during wire stripping.

Proceed as follows:

1. Hold the tool so that the FRONT side is facing you.
2. Ensure that the tool ratchet is released by squeezing the tool handles and allowing them to open FULLY.
3. Holding the contact by its mating portion and looking straight into the crimp section, insert the contact from the BACK of the tool into the appropriate crimp chamber.
4. Position the contact between the crimpers so that the locator/insulation stop enters the slot in the contact. The wire barrel should butt against the locator/insulation stop. Refer to Figures 1 and 2.
5. Holding the contact in this position, squeeze the tool handles together until the insulation anvil starts entry into the insulation crimper (usually two ratchet clicks). Do NOT deform the insulation barrel or wire barrel.
6. Insert a properly stripped wire through the locator slot and into the wire barrel of the contact until the insulation butts against the locator/insulation stop.
7. Holding wire in place, crimp contact to the wire by squeezing the tool handles together until the ratchet releases.
8. Allow tool handles to open FULLY and remove the crimped contact from the tool.

Insulation Adjustment Procedure

On many tools, the insulation barrel crimp height is regulated by the insulation adjustment knob (Figure 1). The insulation crimp should hold the insulation firmly without cutting into the insulation. To determine the proper insulation crimp setting, test

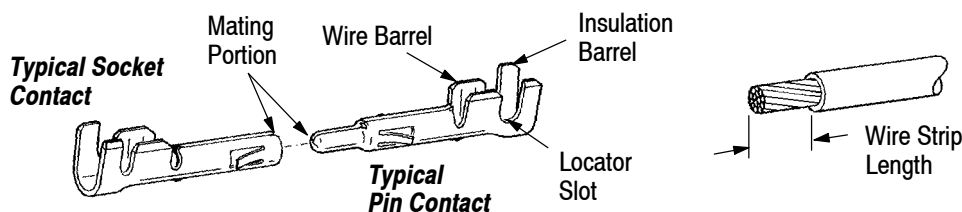

Figure 2

Note: Not to Scale

crimp a loose piece contact using the setting which corresponds to the insulation diameter: (1) -- small; (2) and (3) -- medium; or (4) -- large. If the crimped insulation barrel is too tight or loose, change the setting by pulling out and rotating the adjustment knob to the desired setting.

4. MAINTENANCE AND INSPECTION PROCEDURE

It is recommended that a maintenance and inspection program be performed periodically to ensure dependable and uniform terminations. Frequency of inspection depends on:

- The care, amount of use, and handling of the hand tool,
- The presence of abnormal amounts of dust and dirt,
- The degree of operator skill, and
- Your own established standards.

The hand tool is inspected before being shipped; however, it is recommended that the tool be inspected immediately upon its arrival at your facility to ensure that the tool has not been damaged during shipment.

4.1. Daily Maintenance

1. Remove dust, moisture, and other contaminants with a clean brush, or a soft, lint-free cloth. Do NOT use objects that could damage the tool.
2. Make certain that the retaining pins are in place and that they are secured with retaining rings. See Figure 4.
3. All pins, pivot points, and bearing surfaces should be protected with a thin coat of any good SAE 20 oil. Do not oil excessively.
4. When the tool is not in use, keep handles closed to prevent objects from becoming lodged in the crimping jaws. Store the tool in a clean, dry area.

4.2. Lubrication

Lubricate all pins, pivot points, and bearing surfaces with SAE 20 oil as follows:

- Tools used in daily production - lubricate daily
- Tools used daily (occasional) - lubricate weekly
- Tools used weekly - lubricate monthly

Wipe excess oil from tool, particularly from crimping area. Oil transferred from the crimping area onto certain terminations may affect the electrical characteristics of an application.

4.3. Periodic Inspection

1. Hand tool may be immersed (handles partially closed) in a reliable commercial degreasing compound (suitable for plastics) to remove accumulated dirt, grease and foreign matter.
2. Close tool handles until ratchet releases and then allow them to open freely. If they do not open quickly

and fully, the spring is defective and must be replaced. See the Section 5.

3. Inspect head assembly for worn, cracked, or broken jaws. If damage is evident, return it for evaluation and repair.

4.4. Crimp Height Inspection

This inspection requires the use of micrometer with a modified anvil as shown in Figure 3.

A recommended Crimp Height Comparator is RS-1019-5LP, which can be purchased from:

Manufacturer	Telephone
Shearer Industrial Supply Co	717-767-7575
VALCO	610-691-3205

Crimp Height Comparator 3-576692-6 is recommended in Great Britain; Crimp Height Comparator 675836-0 and -1 are recommended in Germany.

Part Number	Description	Manufacturer	Ref. Number
3-576692-6	Digital Readout Imperial/Metric 0-1 In/0-25.4mm	Mitutoyo Corp., Japan	342-431-30
675836-0, -1	675836-0, -1 Mech. Readout Metric 0-25mm		112-401

Proceed as follows:

1. Select a contact and a wire (maximum size) for each crimp section listed in the appropriate table at <http://tooling.tycoelectronics.com>.
2. Refer to the Section 3, and crimp the contact(s).
3. Using a crimp height comparator, measure wire barrel crimp height as shown in Figure 3. If the crimp height conforms to that marked on the tool, the tool is considered dimensionally correct. If not, return the tool to Tyco Electronics for evaluation and repair (refer to Section 5).

For additional information concerning the use of the crimp height comparator, refer to Instruction Sheet 408-7424.

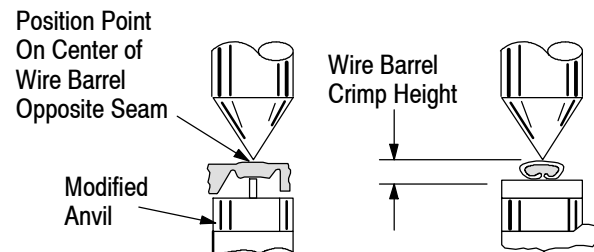

Figure 3

4.5. Ratchet Inspection

The ratchet feature on these hand tools should be checked to ensure that the ratchet does not release prematurely, allowing the crimping dies to open before they have fully bottomed. Obtain a 0.025-mm [.001-in.] shim that is suitable for checking the clearance between the bottoming surfaces of the crimping dies. Proceed as follows:

1. Select the maximum size wire and strip it according to dimensions listed in the drawing shipped with the tool.
2. Select contact and crimp section corresponding to the selected wire size (refer to the drawing shipped with the tool).
3. Position the contact and wire in the crimping dies, as described in the CRIMPING PROCEDURE section.
4. Hold the wire in place and squeeze the handles until the ratchet releases. Hold the handles in this position, maintaining just enough tension to keep the dies closed.
5. Check the clearance between the bottoming surfaces of the wire crimper and the wire anvil. See Figure 1. If the clearance is 0.025 mm [.001 in.] or less (on at least two of the bottoming surfaces), the ratchet is satisfactory. If clearance exceeds 0.025 mm [.001 in.], the ratchet is out of adjustment and must be repaired. See Section 5.

NOTE

The insulation crimper does not bottom on the insulation anvil.

5. REPLACEMENT AND REPAIR

Replacement parts are listed in Figure 4. Parts other than those listed in Figure 4 should be replaced by Tyco Electronics to ensure quality and reliability of the tool. Order replacement parts through your Tyco Electronics Representative, or call 1-800-526-5142, or refer to the appropriate website:

- toolrepair@tycoelectronics.com
- asia.tool@tycoelectronics.com
- jp_tool@tycoelectronics.com
- uktoolingservicecentre@tycoelectronics.com

Tools may also be returned for evaluation and repair. For tool repair service, contact a Tyco Electronics Representative at: 1-800-526-5136, or reference the appropriate website above.

6. REVISION SUMMARY

- Updated document to corporate requirements

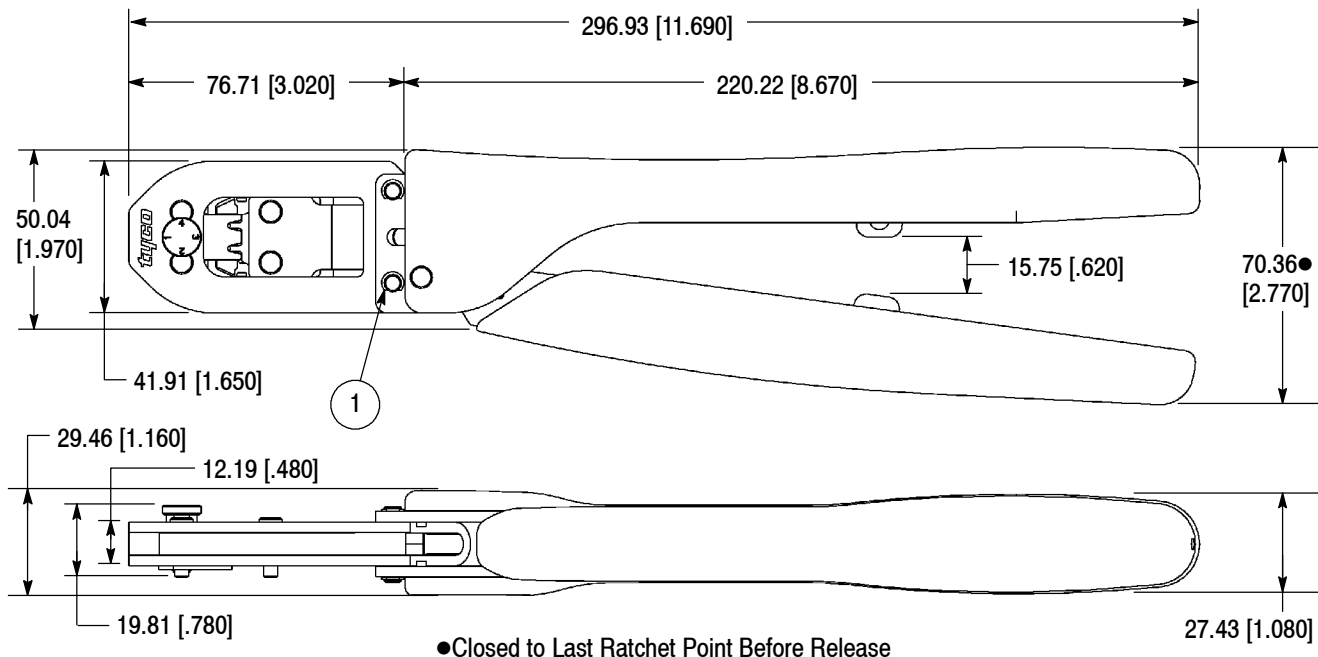

REPLACEABLE PARTS

ITEM	PART NUMBER	DESCRIPTION	QTY PER TOOL
1	21045-3	RING, Retaining	4

Figure 4

TOOL NUMBER	WIRE SIZE mm ² [AWG]	INSULATION DIAMETER mm [in.]	INSUL. ADJ.	STRIP LENGTH mm [in.]	CRIMP HEIGHT mm [in.]	CONTACT PART NUMBERS				CONTACT DESCRIPT.	APPLIC. SPECIF.
						LOOSE PIECE		STRIP FORM			
91500-1 91500-3 91500-4	0.5 - 0.9 [20-18] 1.2 - 2.1 [16-14]	1.52 - 3.30 [.060 - .130]	YES	4.75±0.38 [.187±.015]	1.27±0.05 [.050±.002] 1.60±0.05 [.063±.002]	350547-[] 350550-[] 350669-[] 350705-[] 770250-[] 770251-[] 770254-[]	350218-[] 350536-[] 350654-[] 350687-[] 770007-[] 770008-[] 770193-[]	Univ. MATE-N-LOK Contacts	114-1010 & 114-1011		
91506-1 91506-3	1.21 - 2.1 [16-14]	3.3 - 5.1 [.130 - .200]	YES	4.75±0.38 [.187±.015]	1.60±0.05 [.063±.002]	350551-[] 350552-[] 350707-[] 350919-[] 350918-[] 770249-[] 770248-[] 770255-[]	350537-[] 350538-[] 350700-[] 350874-[] 350873-[] 770006-[] 770005-[] 770194-[]	Univ. MATE-N-LOK Contacts	114-1010 & 114-1011		
91508-1 91508-3	0.5 - 0.9 [20-18]	3.3 - 5.1 [.130 - .200]	YES	4.75±0.38 [.187±.015]	1.24±0.05 [.049±.002]	350551-[] 350552-[] 350918-[] 770249-[] 770248-[] 770255-[]	350537-[] 350538-[] 350700-[] 350874-[] 350873-[] 770006-[] 770005-[] 770194-[]	Univ. MATE-N-LOK Contacts	114-1010 & 114-1011		
91510-1 91510-3	0.2 - 0.38 [24-22] 0.5 - 0.9 [20-18]	1.02 - 2.54 [.040 - .100]	YES	4.75±0.38 [.187±.015]	1.02±0.05 [.040±.002] 1.17±0.05 [.046±.002]	350689-[] 350690-[] 350706-[] 640347-[] 770252-[] 770253-[]	350570-[] 350561-[] 350700-[] 350874-[] 770009-[] 770010-[]	Univ. MATE-N-LOK Contacts	114-1010 & 114-1011		
91522-1 91522-3	0.32 - 0.6 [22-20] (1 wire) 0.8-0.9 [18] (2 wire) 0.31-0.38 [22]	1.50 - 2.2 [.059 - .087] (1 wire) 1.54-2.4 [.059-.095] (2 wire) 1.5-1.7 [.059-.067]	YES	3.45±0.25 [.136±.010] (1 wire) 3.45±0.25 [.136±.010] (2 wire) 3.7±0.2 [.146±.008]	0.79±0.05 [.031±.002] 1.04±0.05 [.041±.002]	170364-[] 170366-[] 770987-[] 770988-[] 794228-[] 794229-[]	170360-[] 170362-[] 770903-[] 770904-[] 794220-[] 794221-[]	Mini-Univ. MATE-N-LOK Contacts	114-5050 & 114-16017		
91529-1 91529-3	0.12 - 0.24 [26-24] 0.32 - 0.38 [22]	1.2 - 1.75 [.047 - .069]	YES	3.45±0.25 [.136±.010]	0.69±0.05 [.027±.002] 0.79±0.05 [.031±.002]	170363-[] 170365-[] 770985-[] 770986-[] 794226-[] 794227-[]	170359-[] 170361-[] 770901-[] 770902-[] 794136-[] 794218-[] 794219-[]	Mini-Univ. MATE-N-LOK Contacts	114-5050 & 114-16017		
91536-1 91536-3	0.5 - 0.9 [20-18] (1 wire) 1.2-1.4 [16] (2 wire) 0.5-0.6 [20]	2.0 - 3.0 [.079 - .118] (1 wire) 2.5-3.2 [.098-.126] (2 wire) 2.0-2.4 [.079-.094]	YES	3.45±0.25 [.136±.010] (1 wire) 3.45±0.25 [.136±.010] (2 wire) 3.70±0.20 [.146±.008]	1.06±0.05 [.042±.002] 1.29±0.05 [.051±.002]	171638-[] 171639-[]	171636-[] 171637-[]	Mini-Univ. MATE-N-LOK Contacts	114-5050 & 114-16017		
91594-1 91594-3	0.50-0.89 [20-18] 0.50-1.42x2 [16-20x2]	2.00-3.20 [.079-.126] 2.26-3.20 [.098-.126]	YES	(1 wire) 3.45±0.25 [.136±.010] (2 wire) 3.70±0.20 [.146±.008]	1.07±0.05 [.042±.002] 1.29±0.05 [.051±.002]	794230-[] 794231-[]	794222-[] 794223-[]	Mini-Univ. MATE-N-LOK 2 Contacts	114-1111		

△ LIST OF APPLIED CONTACT PART NUMBERS MAY NOT BE COMPLETE AND IS SUBJECT TO CHANGE. FOR CURRENT INFORMATION ON TERMINAL PART NUMBERS, CONTACT THE TOOLING ASSISTANCE CENTER: 1-800-722-1111.

2. AMP, CERTI-CRIMP, and MATE-N-LOK are trademarks.

△ -1 IS A CERTICRIMP II HAND TOOL ASSEMBLY.
-3 IS A CERTICRIMP II HEAD SUB-ASSEMBLY.
△ SUPERSEDED
△ -4 IS A CERTICRIMP II HAND TOOL ASSEMBLY FOR SMALL INSULATION DIAMETER.

DATE: 21SEP2001	BY: D COLLECT	TYCO ELECTRONICS
CHK: 23OCT2001	APPD: J GULLA	YACO ELECTRONICS
PRODUCT SPEC: R. SCHAEFFER	NAME: CERTI-CRIMP II TOOL DATA SHEET	HARRISBURG, PA 17105-3608
APPLICATION SPEC:	UNIVERSAL MATE-N-LOK CONTACT FAMILY	
WEIGHT:	SCALE: A200779	SHEET 1 OF 2
CUSTOMER DRAWING:	RESTRICTED TO:	

4











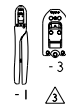
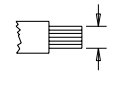
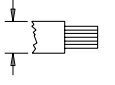

3

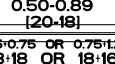
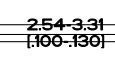
2

1

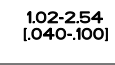
THIS DRAWING IS UNPUBLISHED. RELEASED FOR PUBLICATION BY TYCO ELECTRONICS CORPORATION. ALL RIGHTS RESERVED. COPYRIGHT 20

LOC	DIST	REVISIONS		
A	00	REV	DATE	BY
		1		
		- SEE SHEET 1		

TOOL NUMBER	WIRE SIZE mm ² [AWG]	INSULATION DIAMETER mm [in.]	INSUL. ADJ.	STRIP LENGTH mm [in.]	CRIMP HEIGHT mm [in.]	CONTACT PART NUMBERS Δ		CONTACT DESCRIPT.	APPLIC. SPECIF.
						LOOSE PIECE	STRIP FORM		
 -1 Δ	 0.20-0.56 [24-20] 0.75-0.89 [18]	 1.52-2.54 [.060-.100]	 YES	 5.16±0.38 [.203±.015]	 1.05±0.08 [.041±.003] 1.27±0.08 [.050±.003]	350689-[]	350570-[]	Universal MATE-N-LOK Contacts	114-1010 & 114-1011
						350690-[]	350561-[]		
						350706-[]	350699-[]		
 -3 Δ	 0.50-0.89 [20-18] 0.75-0.75 OR 0.75-1.25 [18-18 OR 18-16]	 2.54-3.31 [.100-.130]	 YES	 5.16±0.38 [.203±.015]	 1.29-1.45 [.051-.057] 1.60-1.75 [.063-.069]	350547-[]	350218-[]	Universal MATE-N-LOK Contacts	114-1010 & 114-1011
						350705-[]	350687-[]		
						350669-[]	350564-[]		
 -4 Δ	18 GA SOLID	 1.02-2.54 [.040-.100]	 YES	 4.37-0.38 [.172-.015]	 1.118±.025 [.044±.001]	350689-[]	350851-[]	Universal MATE-N-LOK Contacts	114-1010 & 114-1011
						350550-[]	350536-[]		
						350690-[]	350561-[]		
						350547-[]	350218-[]		

Δ LIST OF APPLIED CONTACT PART NUMBERS MAY NOT BE COMPLETE AND IS SUBJECT TO CHANGE. FOR CURRENT INFORMATION ON TERMINAL PART NUMBERS, CONTACT THE TOOLING ASSISTANCE CENTER : 1-800-722-1111.

2. AMP, CERTI-CRIMP, and MATE-N-LOK are trademarks.

Δ -1 IS A CERTICRIMP II HAND TOOL ASSEMBLY.
 Δ -3 IS A CERTICRIMP II HEAD SUB-ASSEMBLY.

Δ SUPERSEDED

Δ -4 IS A CERTICRIMP II HAND TOOL ASSEMBLY FOR SMALL INSULATION DIAMETER.

DIMENSIONS: mm		TO MANUFACTURE THIS DRAWING FOR THE CUSTOMER'S INFORMATION, THE CUSTOMER'S SPECIFICATIONS SHALL BE CONTACTED FOR THE CORRECT VERSION.		DATE: 21SEP2001 COLLECTOR: J. GULLA APPROVED: R. SCHAEFFER	Tyco Electronics Harrisburg, PA 17105-3608
MATERIAL: -		FINISH: -		WEIGHT: - CUSTOMER DRAWING	SHEET: A200779 CASE CODE: C=1583000 DRAWING NO: - RESTRICTED TO: -
				SCALE: -	SHEET 2 OF 2 REV B

AMP 1471-9 REV 31MAR2000