

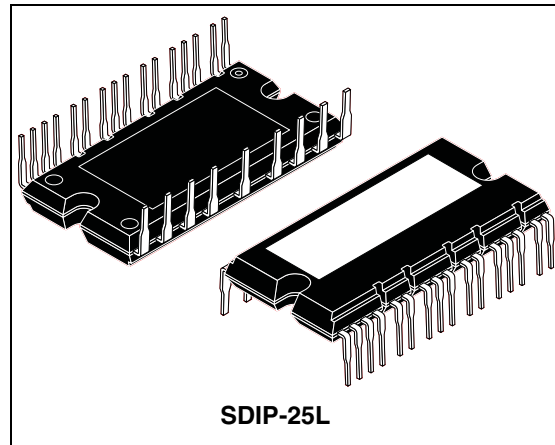


# STGIPS10K60A

IGBT intelligent power module (IPM)  
10 A, 600 V, DBC isolated SDIP-25L molded

## Features

- 10 A, 600 V, 3-phase IGBT inverter bridge including control ICs for gate driving and free-wheeling diodes
- 3.3 V, 5 V, 15 V CMOS/TTL inputs comparators with hysteresis and pull down resistor
- Internal bootstrap diode
- Interlocking function
- 5 k $\Omega$  NTC thermistor for temperature control
- $V_{CE(sat)}$  negative temperature coefficient
- Short-circuit rugged IGBT
- Under-voltage lockout
- DBC fully isolated package
- Isolation rating of 2500 Vrms/min.



## Applications

- 3-phase inverters for low power motor drives
- Home appliances, such as washing machines, refrigerators, air conditioners

## Description

The STGIPS10K60A intelligent power module provides a compact, high performance AC motor drive for a simple and rugged design. It mainly targets low power inverters for applications such as home appliances and air conditioners. It combines ST proprietary control ICs with the most advanced short circuit rugged IGBT system technology. Please refer to dedicated technical note TN0107 for mounting instructions.

**Table 1. Device summary**

Order code	Marking	Package	Packaging
STGIPS10K60A	GIPS10K60A	SDIP-25L	Tube

---

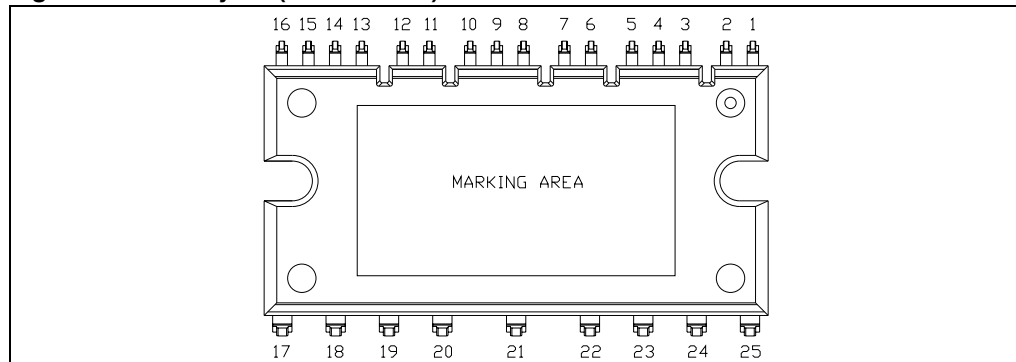
# Contents

<b>1</b>	<b>Internal block diagram and pin configuration</b>	<b>3</b>
<b>2</b>	<b>Electrical ratings</b>	<b>5</b>
2.1	Absolute maximum ratings	5
2.2	Thermal data	6
<b>3</b>	<b>Electrical characteristics</b>	<b>7</b>
3.1	Control part	9
3.1.1	NTC thermistor	10
<b>4</b>	<b>Applications information</b>	<b>12</b>
4.1	Recommendations	13
<b>5</b>	<b>Package mechanical data</b>	<b>14</b>
<b>6</b>	<b>Revision history</b>	<b>16</b>



**Table 2. Pin description**

Pin	Symbol	Description
1	OUT <sub>U</sub>	High side reference output for U phase
2	V <sub>boot U</sub>	Bootstrap voltage for U phase
3	LIN <sub>U</sub>	Low side logic input for U phase
4	HIN <sub>U</sub>	High side logic input for U phase
5	V <sub>CC</sub>	Low voltage power supply
6	OUT <sub>V</sub>	High side reference output for V phase
7	V <sub>boot V</sub>	Bootstrap voltage for V phase
8	GND	Ground
9	LIN <sub>V</sub>	Low side logic input for V phase
10	HIN <sub>V</sub>	High side logic input for V phase
11	OUT <sub>W</sub>	High side reference output for W phase
12	V <sub>boot W</sub>	Bootstrap voltage for W phase
13	LIN <sub>W</sub>	Low side logic input for W phase
14	HIN <sub>W</sub>	High side logic input for W phase
15	T <sub>1</sub>	NTC thermistor terminal 1
16	T <sub>2</sub>	NTC thermistor terminal 2
17	N <sub>W</sub>	Negative DC input for W phase
18	W	W phase output
19	P	Positive DC input
20	N <sub>V</sub>	Negative DC input for V phase
21	V	V phase output
22	P	Positive DC input
23	N <sub>U</sub>	Negative DC input for U phase
24	U	U phase output
25	P	Positive DC input

**Figure 2. Pin layout (bottom view)**

## 2 Electrical ratings

### 2.1 Absolute maximum ratings

**Table 3. Inverter part**

Symbol	Parameter	Value	Unit
$V_{PN}$	Supply voltage applied between P - N <sub>U</sub> , N <sub>V</sub> , N <sub>W</sub>	450	V
$V_{PN(surge)}$	Supply voltage (surge) applied between P - N <sub>U</sub> , N <sub>V</sub> , N <sub>W</sub>	500	V
$V_{CES}$	Collector emitter voltage ( $V_{IN}^{(1)} = 0$ )	600	V
$\pm I_C^{(2)}$	Each IGBT continuous collector current at $T_C = 25^\circ\text{C}$	10	A
$\pm I_{CP}^{(3)}$	Each IGBT pulsed collector current	20	A
$P_{TOT}$	Each IGBT total dissipation at $T_C = 25^\circ\text{C}$	26	W
$t_{scw}$	Short-circuit withstand time, $V_{CE} = 0.5 V_{(BR)CES}$ $T_J = 125^\circ\text{C}$ , $V_{CC} = V_{boot} = 15\text{ V}$ , $V_{IN}^{(1)} = 5\text{ V}$	5	$\mu\text{s}$

1. Applied between HIN<sub>i</sub>, LIN<sub>i</sub> and GND for i = U, V, W.
2. Calculated according to the iterative formula:

$$I_C(T_C) = \frac{T_{j(max)} - T_C}{R_{thj-c} \times V_{CE(sat)(max)}(T_{j(max)}, I_C(T_C))}$$

3. Pulse width limited by max junction temperature.

**Table 4. Control part**

Symbol	Parameter	Value	Unit
$V_{OUT}$	Output voltage applied between OUT <sub>U</sub> , OUT <sub>V</sub> , OUT <sub>W</sub> - GND ( $V_{CC} = 15\text{ V}$ )	-3 to $V_{boot} - 18$	V
$V_{CC}$	Low voltage power supply	-0.3 to +18	V
$V_{boot}$	Bootstrap voltage applied between $V_{boot\ i} - OUT_i$ for i = U, V, W	-1 to 618	V
$V_{IN}$	Logic input voltage applied between HIN <sub>i</sub> , LIN <sub>i</sub> and GND for i = U, V, W	-0.3 to $V_{CC} + 0.3$	V
$dV_{out}/dt$	Allowed output slew rate	50	V/ns

Table 5. Total system

Symbol	Parameter	Value	Unit
$V_{ISO}$	Isolation withstand voltage applied between each pin and heatsink plate (AC voltage, $t = 60\text{sec.}$ )	2500	V
$T_j$	Operating junction temperature	-40 to 125	°C

## 2.2 Thermal data

Table 6. Thermal data

Symbol	Parameter	Value	Unit
$R_{thj-c}$	Thermal resistance junction-case single IGBT max.	3.8	°C/W
	Thermal resistance junction-case single diode max.	5.5	°C/W

### 3 Electrical characteristics

( $T_j = 25^\circ\text{C}$  unless otherwise specified).

**Table 7. Inverter part**

Symbol	Parameter	Test conditions	Value			Unit
			Min.	Typ.	Max.	
$V_{CE(sat)}$	Collector-emitter saturation voltage	$V_{CC} = V_{boot} = 15\text{ V}$ , $V_{IN}^{(1)} = 5\text{ V}$ , $I_C = 5\text{ A}$	-	2.1	2.5	V
		$V_{CC} = V_{boot} = 15\text{ V}$ , $V_{IN}^{(1)} = 5\text{ V}$ , $I_C = 5\text{ A}$ , $T_j = 125^\circ\text{C}$	-	1.8		
$I_{CES}$	Collector-cut off current ( $V_{IN}^{(1)}=0$ )	$V_{CE} = 600\text{ V}$ $V_{CC} = V_{boot} = 15\text{ V}$	-		100	$\mu\text{A}$
$V_F$	Diode forward voltage	$V_{IN}^{(1)} = 0$ , $I_C = 5\text{ A}$	-		1.9	V
<b>Inductive load switching time and energy</b>						
$t_{on}$	Turn-on time	$V_{DD} = 300\text{ V}$ , $V_{CC} = V_{boot} = 15\text{ V}$ , $V_{IN}^{(1)} = 0 \div 5\text{ V}$ , $I_C = 5\text{ A}$ (see <a href="#">Figure 4</a> )	-	320	-	ns
$t_{c(on)}$	Crossover time (on)		-	70	-	
$t_{off}$	Turn-off time		-	430	-	
$t_{c(off)}$	Crossover time (off)		-	135	-	
$t_{rr}$	Reverse recovery time		-	130	-	
$E_{on}$	Turn-on switching losses		-	65	-	$\mu\text{J}$
$E_{off}$	Turn-off switching losses		-	75	-	

1. Applied between  $HIN_i$ ,  $LIN_i$  and GND for  $i = U, V, W$ .

**Note:**  $t_{ON}$  and  $t_{OFF}$  include the propagation delay time of the internal drive.  $t_{C(ON)}$  and  $t_{C(OFF)}$  are the switching time of IGBT itself under the internally given gate driving condition.

Figure 3. Switching time test circuit

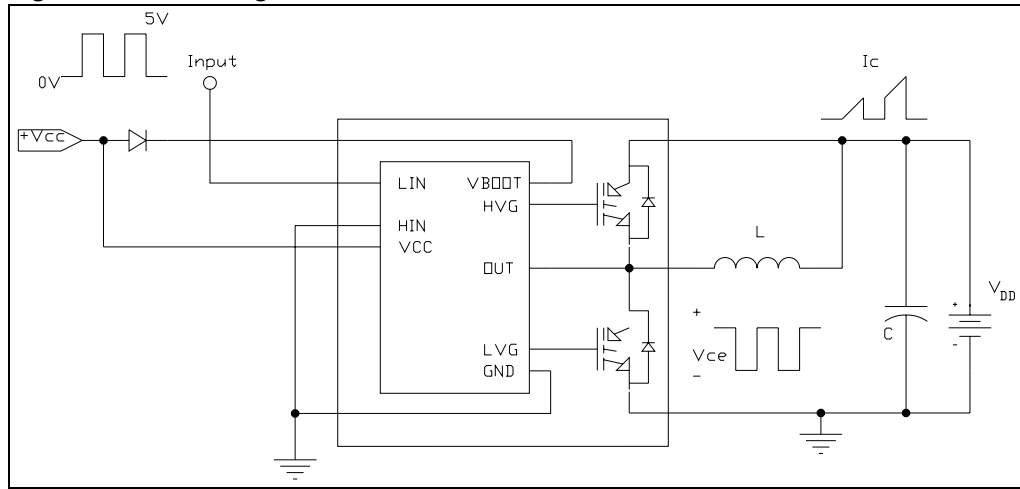
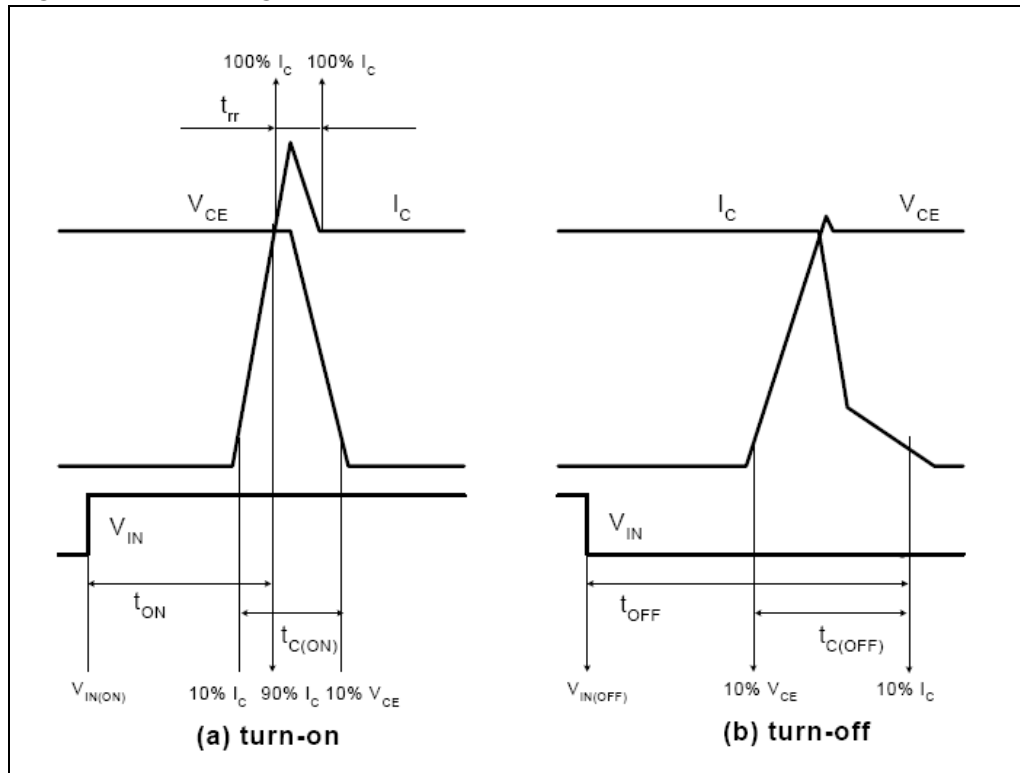


Figure 4. Switching time definition





### 3.1 Control part

**Table 8. Low supply voltage**

Symbol	Parameter	Test conditions	Min.	Typ.	Max.	Unit
$V_{CCth1}$	Under voltage turn on threshold		9.1	9.6	10.1	V
$V_{CCth2}$	Under voltage turn off threshold		7.9	8.3	8.8	V
$V_{CChys}$	Under voltage hystereses		0.9			V
$I_{qccu}$	Under voltage quiescent supply current	$V_{CC} < 9\text{ V}$		0.75	1.2	mA
$I_{qcc}$	Quiescent current	$V_{CC} = 15\text{ V}$		1	1.5	mA
$R_{DS(on)}$	Bootstrap driver on resistance	$V_{CC} > 12.5\text{ V}$		125		$\Omega$

**Table 9. Bootstrap supply**

Symbol	Parameter	Test conditions	Min.	Typ.	Max.	Unit
$V_{boot1}$	Under voltage turn on threshold	-	8.5	9.5	10.5	V
$V_{boot2}$	Under voltage turn off threshold	-	7.2	8.3	9.2	V
$V_{boothys}$	Under voltage hystereses	-	0.9			V
$I_{qboot}$	Quiescent current	-			250	$\mu\text{A}$

**Table 10. Logic input <sup>(1)</sup>**

Symbol	Parameter	Test conditions	Min.	Typ.	Max.	Unit
$V_{il}$	Low level logic input voltage				1.1	V
$V_{ih}$	High level logic input voltage		1.8			V
$I_{il}$	Low level logic input current	$V_{IN}^{(2)} = 0$	-1			$\mu\text{A}$
$I_{ih}$	High level logic input current	$V_{IN}^{(1)} = 15\text{ V}$		20	70	$\mu\text{A}$

1. See [Figure 8: Dead time and interlocking definition](#).
2. Applied between  $HIN_i$ ,  $LIN_i$  and GND for  $i = U, V, W$

### 3.1.1 NTC thermistor

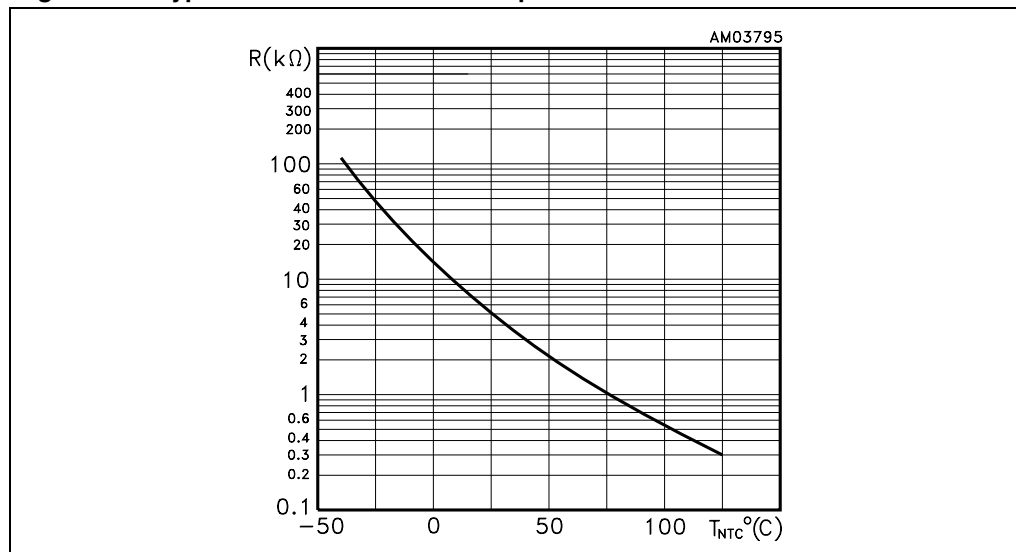
Table 11. NTC thermistor

Symbol	Parameter	Test conditions	Min.	Typ.	Max.	Unit.
R <sub>25</sub>	Resistance	T <sub>C</sub> = 25°C		5		kΩ
R <sub>125</sub>	Resistance	T <sub>C</sub> = 125°C		300		Ω
B	B-constant	T <sub>C</sub> = 25°C		3435		k
T	Operating temperature		-40		125	°C

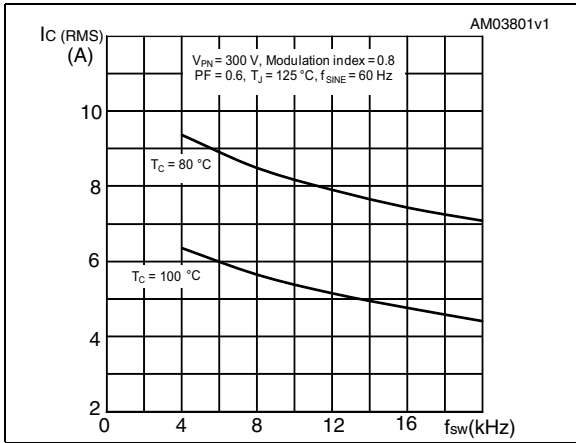
Equation 1: resistance variation vs temperature

$$R(T) = R_{25} \cdot e^{B \left( \frac{1}{T} - \frac{1}{298k} \right)}$$

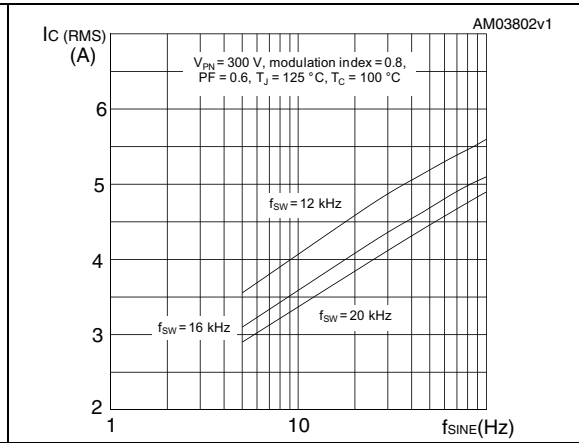
Figure 5. Typical NTC resistance vs temperature



**Figure 6. Maximum  $I_{C(RMS)}$  current vs. switching frequency (1)**

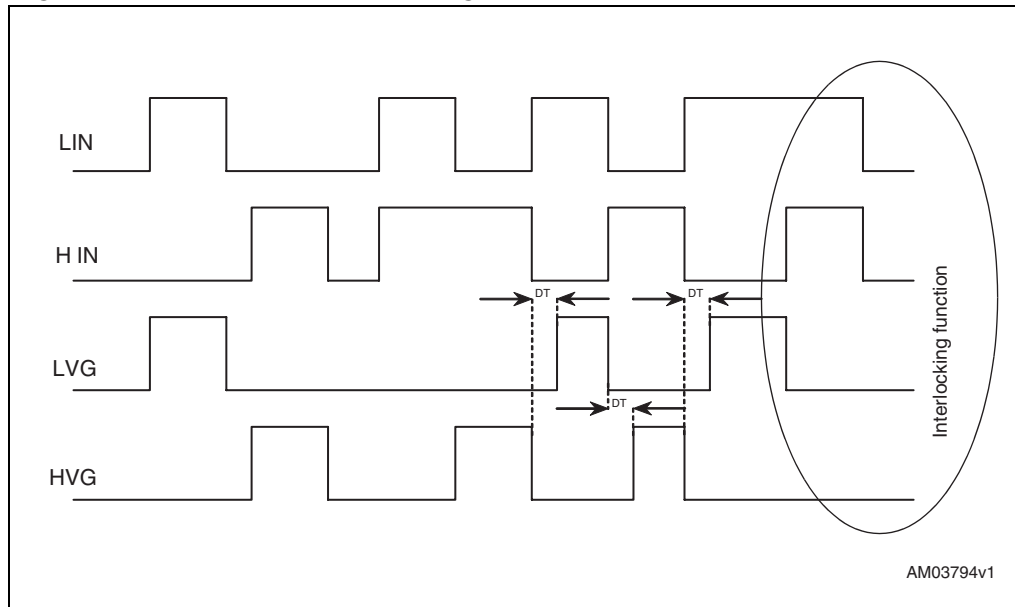


**Figure 7. Maximum  $I_{C(RMS)}$  current vs.  $f_{SINE}$  (1)**



1. Simulated curves refer to typical IGBT parameters and maximum  $R_{thj-c}$ .

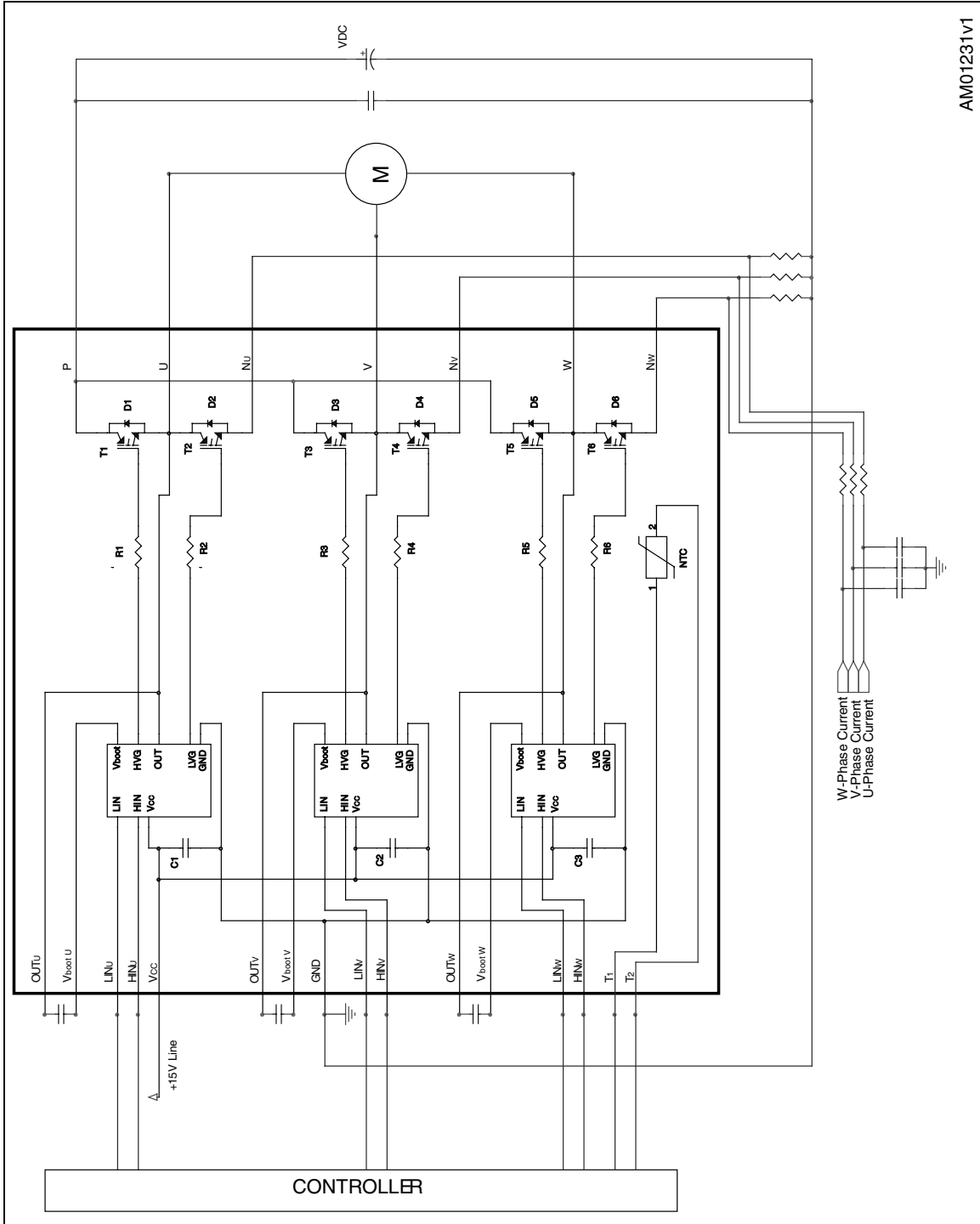
**Figure 8. Dead time and interlocking definition**



Minimum recommended dead time (DT) between low and high side logic input: 1  $\mu\text{s}$ .

# 4 Applications information

Figure 9. Typical application circuit



## 4.1 Recommendations

- To prevent the input signals oscillation, the wiring of each input should be as short as possible.
- By integrating an application specific type HVIC inside the module, direct coupling to MCU terminals without any opto-coupler is possible.
- Each capacitor should be located as nearby the pins of IPM as possible.
- Low inductance shunt resistors should be used for phase leg current sensing.
- Electrolytic bus capacitors should be mounted as close to the module bus terminals as possible. Additional high frequency ceramic capacitor mounted close to the module pins will further improve performance.

**Table 12. Recommended operating conditions**

Symbol	Parameter	Conditions	Value			Unit
			Min.	Typ.	Max.	
$V_{PN}$	Supply Voltage	Applied between P-Nu,Nv,Nw		300	400	V
$V_{CC}$	Control supply voltage	Applied between $V_{CC}$ -GND	13.5	15	16	V
$V_{BS}$	High side bias voltage	Applied between $V_{BOOTi}$ - $OUT_i$ for $i=U,V,W$			16	V
$t_{dead}$	Blanking time to prevent Arm-short	For each input signal	1			$\mu$ s
$f_{PWM}$	PWM input signal	-40°C < $T_c$ < 100°C -40°C < $T_j$ < 125°C			20	kHz

## 5 Package mechanical data

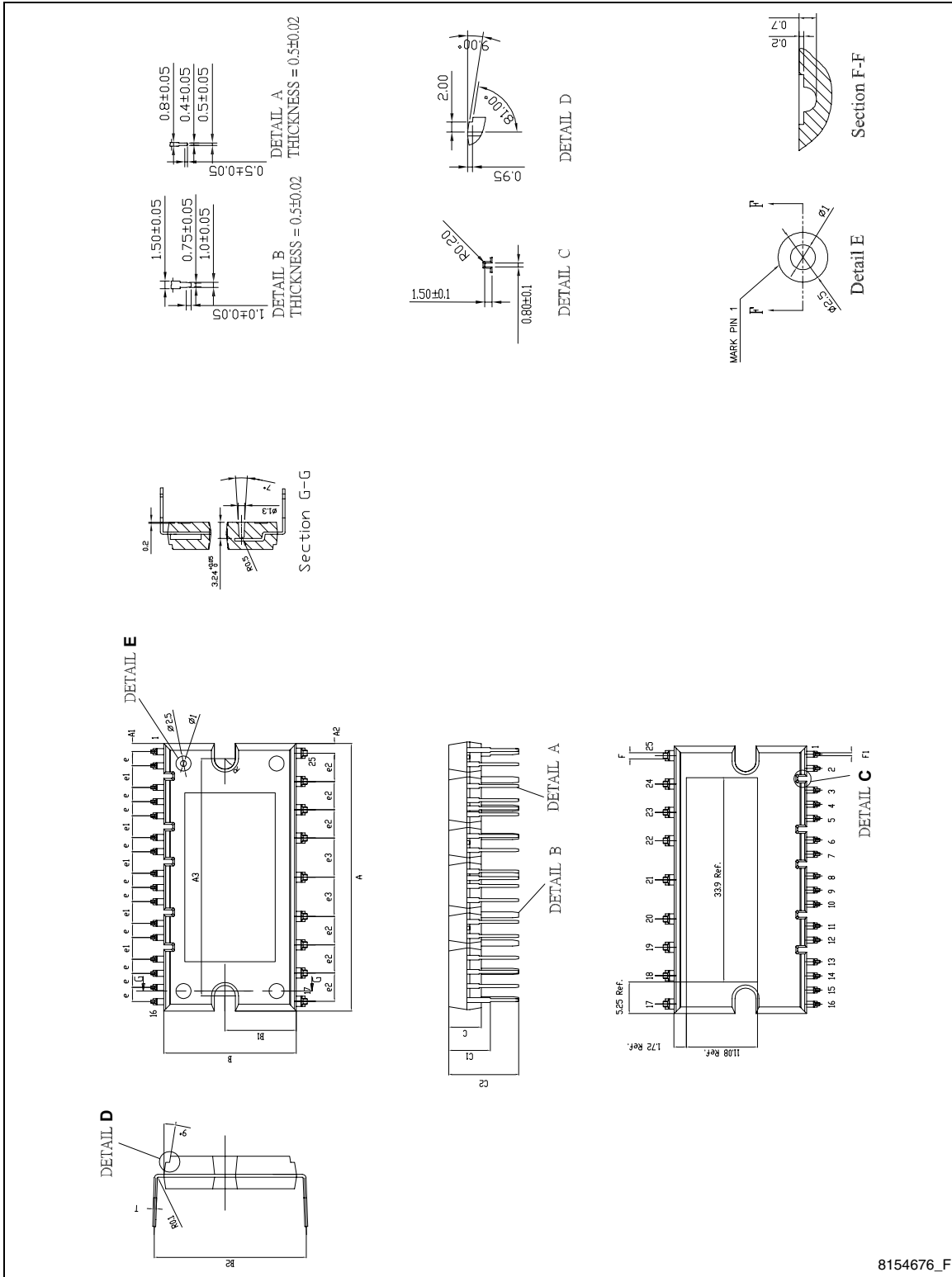
In order to meet environmental requirements, ST offers these devices in different grades of ECOPACK<sup>®</sup> packages, depending on their level of environmental compliance. ECOPACK<sup>®</sup> specifications, grade definitions and product status are available at: [www.st.com](http://www.st.com). ECOPACK is an ST trademark.

Please refer to dedicated technical note TN0107 for mounting instructions.

**Table 13. SDIP-25L package mechanical data**

Dim.	(mm.)		
	Min.	Typ.	Max.
A	44		44.8
A1	0.95		1.75
A2	1.2		2
A3	39		39.8
B	21.6		22.4
B1	11.45		12.25
B2	24.83	25.22	25.63
C	5		5.8
C1	6.4		7.4
C2	11.1		12.1
e	1.95	2.35	2.75
e1	3.2	3.6	4
e2	4.3	4.7	5.1
e3	6.1	6.5	6.9
F	0.8	1.0	1.2
F1	0.3	0.5	0.7
R	1.35		2.15
T	0.4	0.55	0.7

Figure 10. SDIP-25L package mechanical data



## 6 Revision history

**Table 14. Document revision history**

Date	Revision	Changes
16-Apr-2009	1	Initial release.
11-May-2009	2	Added <a href="#">Figure 6</a> and <a href="#">Figure 7</a> .
17-Jul-2009	3	Reduced $V_{CE(sat)}$ value on <a href="#">Table 7</a> .
06-Apr-2010	4	Document promoted from preliminary data to datasheet. Inserted <a href="#">Figure 3: Switching time test circuit</a> and <a href="#">Table 12: Recommended operating conditions</a> . Updated <a href="#">Table 5: Total system</a> , <a href="#">Table 6: Thermal data</a> , <a href="#">Table 7: Inverter part</a> , <a href="#">Figure 5: Typical NTC resistance vs temperature</a> , <a href="#">Figure 6: Maximum IC(RMS) current vs. switching frequency</a> , <a href="#">Figure 7: Maximum IC(RMS) current vs. fSINE (1)</a> and <a href="#">Section 5: Package mechanical data</a> .
15-Jun-2010	5	Updated <a href="#">Table 7: Inverter part</a> . Minor text changes to improve readability.



**Please Read Carefully:**

Information in this document is provided solely in connection with ST products. STMicroelectronics NV and its subsidiaries ("ST") reserve the right to make changes, corrections, modifications or improvements, to this document, and the products and services described herein at any time, without notice.

All ST products are sold pursuant to ST's terms and conditions of sale.

Purchasers are solely responsible for the choice, selection and use of the ST products and services described herein, and ST assumes no liability whatsoever relating to the choice, selection or use of the ST products and services described herein.

No license, express or implied, by estoppel or otherwise, to any intellectual property rights is granted under this document. If any part of this document refers to any third party products or services it shall not be deemed a license grant by ST for the use of such third party products or services, or any intellectual property contained therein or considered as a warranty covering the use in any manner whatsoever of such third party products or services or any intellectual property contained therein.

**UNLESS OTHERWISE SET FORTH IN ST'S TERMS AND CONDITIONS OF SALE ST DISCLAIMS ANY EXPRESS OR IMPLIED WARRANTY WITH RESPECT TO THE USE AND/OR SALE OF ST PRODUCTS INCLUDING WITHOUT LIMITATION IMPLIED WARRANTIES OF MERCHANTABILITY, FITNESS FOR A PARTICULAR PURPOSE (AND THEIR EQUIVALENTS UNDER THE LAWS OF ANY JURISDICTION), OR INFRINGEMENT OF ANY PATENT, COPYRIGHT OR OTHER INTELLECTUAL PROPERTY RIGHT.**

**UNLESS EXPRESSLY APPROVED IN WRITING BY AN AUTHORIZED ST REPRESENTATIVE, ST PRODUCTS ARE NOT RECOMMENDED, AUTHORIZED OR WARRANTED FOR USE IN MILITARY, AIR CRAFT, SPACE, LIFE SAVING, OR LIFE SUSTAINING APPLICATIONS, NOR IN PRODUCTS OR SYSTEMS WHERE FAILURE OR MALFUNCTION MAY RESULT IN PERSONAL INJURY, DEATH, OR SEVERE PROPERTY OR ENVIRONMENTAL DAMAGE. ST PRODUCTS WHICH ARE NOT SPECIFIED AS "AUTOMOTIVE GRADE" MAY ONLY BE USED IN AUTOMOTIVE APPLICATIONS AT USER'S OWN RISK.**

Resale of ST products with provisions different from the statements and/or technical features set forth in this document shall immediately void any warranty granted by ST for the ST product or service described herein and shall not create or extend in any manner whatsoever, any liability of ST.

ST and the ST logo are trademarks or registered trademarks of ST in various countries.

Information in this document supersedes and replaces all information previously supplied.

The ST logo is a registered trademark of STMicroelectronics. All other names are the property of their respective owners.

© 2010 STMicroelectronics - All rights reserved

STMicroelectronics group of companies

Australia - Belgium - Brazil - Canada - China - Czech Republic - Finland - France - Germany - Hong Kong - India - Israel - Italy - Japan - Malaysia - Malta - Morocco - Philippines - Singapore - Spain - Sweden - Switzerland - United Kingdom - United States of America

[www.st.com](http://www.st.com)

