

65039-034LF

Assistant

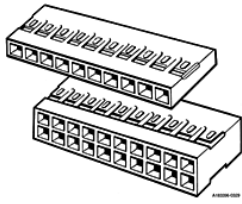

65039-034LF - Mini-PV™, Basics+

2.54 mm (0.1 in.) Centerline Crimp-to-Wire PV Receptacle Housing, Single Row

ACTIVE

Customer Drawing

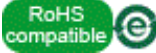

Electronics division

Email Datasheet Print Datasheet

FCI Brings You More

- [Contact our sales/technical support](#)
- [Sample request](#)
- € [Price request](#)
- [Check distributor stock](#)

Direct Links ...>

Cross Reference

RoHS/LF P/N search

Document & Drawing search

Application tooling

Services ...>

Contact us

Distributor list

Pricing request

Order samples

Literature ...>

Brochures & catalogs

Product documentation

Technical library

Mating Half



68000-103HLF Unshrouded header, Through Hole, Single row, 3 Positions, 2.54 mm Pitch, Vertical, 5.84 mm (0.23 in.) Mating, 2.41 mm (0.095 in.) Tail



68015-103HLF Unshrouded header, Through Hole, Single row, 3 Positions, 2.54 mm Pitch, Right Angle, 5.84 mm (0.23 in.) Mating, 2.29 mm (0.09 in.) Tail

Download document

Technical Resources

- [> 3D IGES](#)
- [> RoHS qualification documents](#)
- [> Application Specification](#)
- [> 3D STEP](#)
- [> Product Specification](#)
- [> 3D PROE](#)
- [> Application Specification](#)

Literature

- [> Basics+ Brochure](#)
- [> Connectors for Medical Devices Brochure](#)
- [> Connector Overview Brochure](#)
- [> Basics+ Product Focus](#)
- [> PV@ Connector system](#)
- [> Contacts & Latch Housings Product Focus](#)

Application Tooling

- [> Asia Pacific Application Tooling](#)
- [> Americas Application Tooling](#)
- [> Europe Application Tooling](#)

Specifications

General	Dimensional	Electrical	Physical	Approvals / Certifications	Other Features
General					
Number of contacts				3	
Number of rows				1	
Orientation				Vertical	
Product Type				Crimp-to-Wire Housing	
Polarization (Key)				No	
Mating half				Mates with 0.64 mm (0.025 in.) Square Pin with Length of 5.33 mm (0.21 in.) min. to 6.1 mm (0.24 in.) max.	
Dimensional					
Length (Mating pin)				5.33 mm (0.21 in.) to 6.1 mm (0.24 in)	
Size (Wire)				22 to 36 AWG	
Electrical					
Resistance (Insulation)				100000 M ohms	
Voltage rating				1000V rms	
Physical					
Color (Housing)				Black	
Material (Housing)				PPE+PS	
Temperature (Range)				-40°C to +105°C	
Approvals / Certifications					
Approvals / Certifications				UL and CSA Approved	
Other Features					
Accessory				Polarization Plug 65307-001LF	
Packaging (Type)				Bag	
Comments				PV™ Contact Removal Tool: Part Number HT-0080	

PRODUCT NUMBER
SEE TABLE

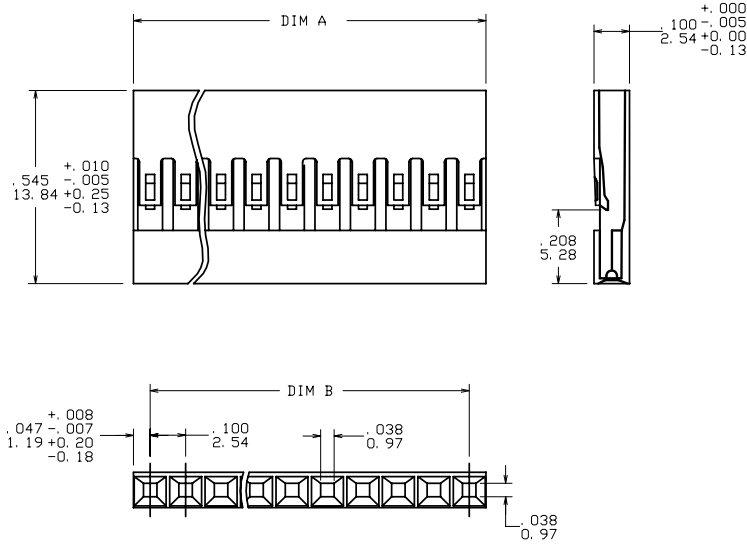

CONFIGURATION 1
(WITHOUT RIB)

NOTES:

- ① MOLDING MATERIAL: MODIFIED POLYPHENYLENE ETHER, COLOR: BLACK, UL 94V-0.
2. PIN LENGTH TO BE .210/5.33 MIN RECOMMENDED PIN LENGTH IS .225/5.72 ± .015/0.38.
3. FOR TERMINAL APPLICATION SEE TA-531. PRODUCT SPECIFICATION: BUS-12-067.
4. TERMINALS MUST BE CRIMPED PROPERLY FOR SATISFACTORY LATCHING. SEE TA-75 FOR CRIMPING INSTRUCTIONS.
5. THIS HOUSING IS INTENDED FOR USE WITH MINI PVM TERMINAL WITH 22-36 GAUGE WIRE.
- ⑥ ALL MARKING EXCEPT LOGO DONE IN "6 POINT TYPE SET" IF SPACE PERMITS APPROX AREA PER NUMBER/LETTER .056/1.42 WIDE X .06/1.5 HIGH USING WHITE PERMANENT INK.
- ⑦ ALL MARKINGS FOR MILITARY PART NUMBERS ARE TO BE PER MIL-STD-1285. SEE TABULATION.
- ⑧ PLACE DESC P/N AND CAGE NO. ON PACKAGING LABEL. PRODUCT LENGTH IS TOO SMALL TO MARK PART.
- ⑨ THESE PARTS ARE AS MOLDED WITH NO MARKINGS AND NO RESTRICTIONS, (BUT ARE MARKETABLE).
10. PRODUCT MEETS EUROPEAN UNION DIRECTIVES AND OTHER COUNTRY REGULATIONS AS DESCRIBED IN GS-22-008.
11. THE PRODUCT IS NOT INTENDED TO BE EXPOSED TO MANUFACTURING SOLDER PROCESS.
- ⑫ EUROPEAN CUSTOMERS SHOULD ORDER PART NUMBERS WITH AN 'E' SUFFIX AS SHOWN IN TABLE TO CONTINUE TO BE SUPPLIED BY THE EUROPEAN PLANT. SEE DRAWING 65039EUR.

mat'l. code	SEE NOTE 1	surface	tolerance	projection	product family
lfr	ec'n no	dr	date	ASME Y14.5 ✓ ASME Y14.5	PV HOUSINGS
BE	v07-0483	HTB	2007-07-24	tolerances unless otherwise specified	title
-	-	-	-	angles	MINI LATCH HOUSING
AY	v03-1356	PJ	2004-01-31	0°±2'	SINGLE ROW .100 [2.54] CC
BA	v05-0712	DAI	2005-07-27	dr	scale 3:1
BB	v06-0407	HTB	2006-04-26	engr	FCJ
BC	v06-0549	HTB	2006-06-12	chr	dwg no
BD	v06-0886	HTB	2006-08-31	appd	65039
sheet	revision	BE	BE	BE	sheet 1 of 12
index	sheet	1	2	3	A4
		4	5	6	Product Customer Drawing
		7	8	9	
		10	11	12	

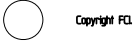

1 | 2

3

4

PRODUCT NUMBER
SEE TABLE

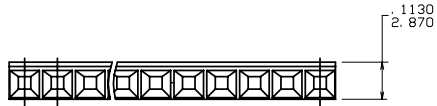
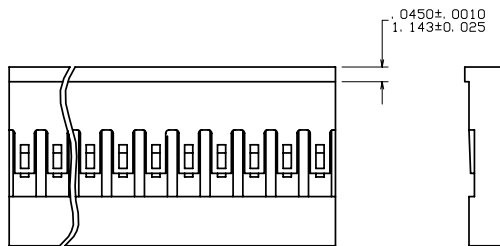

CONFIGURATION 2
(WITH RIB)

mat'l. code		surface		tolerance		projection		product family	
SEE NOTE 1		ASME Y14.5 ✓		ASME Y14.5				PV HOUSINGS	
ltr	ec'n no	dr	date	tolerances unless otherwise specified		INCH/MM		title	
BE				angles	XXX+01/XX+3			MINI LATCH HOUSING	
				0°±2'	XXX+005/XXX+13	scale 3:1		SINGLE ROW .100 [2.54] CC	
					XXXX+0020/XXX+051			dwg no	
		dr	M. CORNMAN	1990-01-31				sheet 2 of 12	
		engr	H. SUNDY	1990-01-31				65039	
		chr	H. SUNDY	1990-01-31				A4	
		appd	H. SUNDY	1990-01-31				type	
sheet	revision							Product Customer Drawing	
index	sheet								

form A4mmXLC

1

2

3

4

<p>PRODUCT NO SEE TABLE</p> <p>MARK CO. LOGO TRADEMARK & PART NO. & CAVITY NO. APPROX. AS SHOWN.</p> <p>STYLE A</p>	<p>MARK CUST NAME AND CAVITY NO. APPROX AS SHOWN.</p> <p>STYLE D</p>	<p>CO. LOGO, CUSTOMER PART NO. LOGO, AND EVERY FIFTH CAVITY MARKED PERMANENTLY AND LEGIBLE IN WHITE INK APPROX AS SHOWN.</p> <p>STYLE G</p>	<p>MARK THIS ENTIRE END WHITE</p> <p>STYLE K</p>
<p>MARK CO. LOGO TRADEMARK & PART NO. & CAVITY NO. APPROX. AS SHOWN.</p> <p>STYLE B</p>	<p>MARK NUMBERS AS SHOWN CHARACTERS TO BE PERMANENT AND LEGIBLE AFTER REACHING #9 CAVITY CONTINUE ONLY MARKING EVERY OTHER ONE; IE. #11, #13, #15 ETC.</p> <p>STYLE E</p>	<p>MARK CHARACTERS AS SHOWN (ONE SIDE ONLY) 1,5,10,15, 20,ETC.</p> <p>STYLE H</p>	<p>MARK CHARACTERS AS SHOWN IN WHITE (ONE SIDE ONLY)</p> <p>STYLE L</p>
<p>MARK LETTERS AS SHOWN CHARACTERS TO BE PERMANENT & LEGIBLE. OMIT (!) POS AS SHOWN</p> <p>STYLE C</p>	<p>MARK ARROW IN WHITE APPROX AS SHOWN.</p> <p>STYLE F</p>	<p>NOTE 6</p> <p>STYLE J</p>	

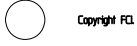

mat'l. code	SEE NOTE 1	surface	tolerance	projection	product family
tr	ecn no	dr	date	ASME Y14.5 ✓ ASME Y14.5	PV HOUSINGS
BE				tolerances unless otherwise specified	title
				angles	MINI LATCH HOUSING
				finishes	SINGLE ROW .100 [2.54] CC
				0°±2'	dwg no
				dr M. CORNMAN 1990-01-31	65039
				enrg H. SUNDY 1990-01-31	sheet 3 of 12 size
				chr H. SUNDY 1990-01-31	A4
				appd H. SUNDY 1990-01-31	type
sheet	revision				Product Customer Drawing
index	sheet				



1 | 2

3 |

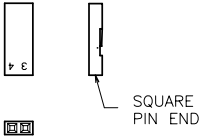
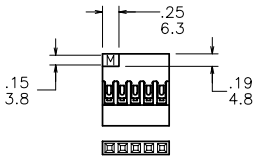
4

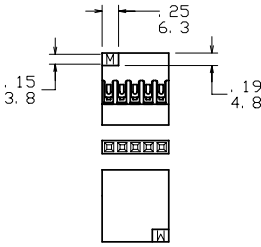
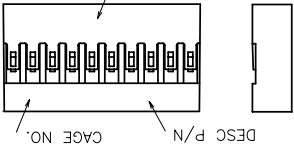
PRODUCT NO SEE TABLE	MARK CHARACTERS ON SIDE OPPOSITE THE LATCHES ON THE PLUGGABLE SQUARE PIN END	MARK AN M (BLACK) IN THE CORNER AS SHOWN, WITH A WHITE BACKGROUND.
 <p>STYLE M</p>	 <p>STYLE P SQUARE PIN END</p>	 <p>STYLE S</p>
CAVITY MARKED WITH ARROW	MARK AN M (BLACK) IN THE CORNER AS SHOWN, WITH A WHITE BACKGROUND, ON BOTH SIDES OF THE PART.	DATE CODE DESC P/N CAGE NO.
 <p>STYLE N</p>	 <p>STYLE R</p>	 <p>STYLE T NOTE-7 & 8</p>

mat'l. code	SEE NOTE 1	surface	tolerance	projection	product family
lfr	ecrn no	dr	date	ASME Y14.5 ✓ ASME Y14.5	PV HOUSINGS
BE				tolerances unless otherwise specified	title
				angles	MINI LATCH HOUSING
				fin	SINGLE ROW .100 [2.54] CC
				0°±2'	dwg no
				XXXX+0020/XXX+051	sheet 4 of 12
		dr	M. CORNMAN	1990-01-31	size
		engr	H. SUNDY	1990-01-31	A4
		chr	H. SUNDY	1990-01-31	
		appd	H. SUNDY	1990-01-31	
sheet index	revision sheet				type
					Product Customer Drawing

form: A4mmXLC

1 |

2 |

3 |

4

Copyright FCJ



FCJconnect.com

1 | 2

3 |

4

PRODUCT NO.	NO.OF POS.	DIM A MAX	DIM B	EUROPEAN VERSION-NOTE 12	CONFIGURATION
65039-001LF	36	3.600/91.44	3.500/88.90	65039-001ELF	1
65039-002LF	35	3.500/88.90	3.400/86.36	65039-002ELF	1
65039-003LF	34	3.400/86.36	3.300/83.82	65039-003ELF	1
65039-004LF	33	3.300/83.82	3.200/81.28	65039-004ELF	1
65039-005LF	32	3.200/81.28	3.100/78.74	65039-005ELF	1
65039-006LF	31	3.100/78.74	3.000/76.20	65039-006ELF	1
65039-007LF	30	3.000/76.20	2.900/73.66	65039-007ELF	1
65039-008LF	29	2.900/73.66	2.800/71.12	65039-008ELF	1
65039-009LF	28	2.800/71.12	2.700/68.58	65039-009ELF	1
65039-010LF	27	2.700/68.58	2.600/66.04	65039-010ELF	1
65039-011LF	26	2.600/66.04	2.500/63.50	65039-011ELF	1
65039-012LF	25	2.500/63.50	2.400/60.96	65039-012ELF	1
65039-013LF	24	2.400/60.96	2.300/58.24	65039-013ELF	1
65039-014LF	23	2.300/58.24	2.200/55.88	65039-014ELF	1
65039-015LF	22	2.200/55.88	2.100/53.34	65039-015ELF	1
65039-016LF	21	2.100/53.34	2.000/50.80	65039-016ELF	1
65039-017LF	20	2.000/50.80	1.900/48.26	65039-017ELF	1
65039-018LF	19	1.900/48.26	1.800/45.72	65039-018ELF	1
65039-019LF	18	1.800/45.72	1.700/43.18	65039-019ELF	1
65039-020LF	17	1.700/43.18	1.600/40.64	65039-020ELF	1
65039-021LF	16	1.600/40.64	1.500/38.10	65039-021ELF	1
65039-022LF	15	1.500/38.10	1.400/35.56	65039-022ELF	1
65039-023LF	14	1.400/35.56	1.300/33.02	65039-023ELF	1
65039-024LF	13	1.300/33.02	1.200/30.48	65039-024ELF	1
65039-025LF	12	1.200/30.48	1.100/27.94	65039-025ELF	1
65039-026LF	11	1.100/27.94	1.000/25.40	65039-026ELF	1
65039-027LF	10	1.000/25.40	.900/22.86	65039-027ELF	1
65039-028LF	9	.900/22.86	.800/20.32	65039-028ELF	1
65039-029LF	8	.800/20.32	.700/17.78	65039-029ELF	1
65039-030LF	7	.700/17.78	.600/15.24	65039-030ELF	1
65039-031LF	6	.600/15.24	.500/12.70	65039-031ELF	1
65039-032LF	5	.500/12.70	.400/10.16	65039-032ELF	1
65039-033LF	4	.400/10.16	.300/7.62	65039-033ELF	1
65039-034LF	3	.300/7.62	.200/5.08	65039-034ELF	1
65039-035LF	2	.200/5.08	.100/2.54	65039-035ELF	1
65039-036LF	1	.100/2.54	—	—	1

mat'l. code	SEE NOTE 1	surface	tolerance	projection	product family
tr	ecrn no	ASME Y14.5 ✓	ASME Y14.5		PV HOUSINGS
BE		tolerances unless otherwise specified	XX±01/XX±3	INCH/MM	title
		angles	XXX±005/XXX±13	scale 3:1	MINI LATCH HOUSING
		0°±2'	XXXX±0020/XXX±051		SINGLE ROW .100 [2.54] CC
		dr	M. CORNMAN 1990-01-31		dwg no
		engr	H. SUNDY 1990-01-31		65039
		chr	H. SUNDY 1990-01-31		sheet 5 of 12
		appd	H. SUNDY 1990-01-31		A4
sheet index	revision sheet				type Product Customer Drawing

form A4mmXLC

1 |

2 |

3 |

4