

2 Cell Battery, 40mW Per Channel Output Capacitor-Less (OCL) Stereo Headphone Audio Amplifier

General Description

The LM4924 is a Output Capacitor-Less (OCL) stereo headphone amplifier, which when connected to a 3.0V supply, delivers 40mW per channel to a 16Ω load with less than 1% THD+N.

With the LM4924 packaged in the MM and SD packages, the customer benefits include low profile and small size. These packages minimize PCB area and maximize output power.

The LM4924 features circuitry that reduces output transients (“clicks” and “pops”) during device turn-on and turn-off, and Mute On and Off. An externally controlled, low-power consumption, active-low shutdown mode is also included in the LM4924. Boomer audio power amplifiers are designed specifically to use few external components and provide high quality output power in a surface mount packages.

Key Specifications

- OCL output power
($R_L = 16\Omega$, $V_{DD} = 3.0V$, THD+N = 1%) 40mW (typ)
- Micropower shutdown current 0.1μA (typ)
- Supply voltage operating range $1.5V < V_{DD} < 3.6V$
- PSRR 100Hz, $V_{DD} = 3.0V$, $A_V = 2.5$ 66dB (typ)

Features

- 2-cell 1.5V to 3.6V battery operation
- OCL mode for stereo headphone operation
- Unity-gain stable
- “Click and pop” suppression circuitry for shutdown On and Off transients
- Active low micropower shutdown
- Thermal shutdown protection circuitry

Applications

- Portable two-cell audio products
- Portable two-cell electronic devices

Typical Application

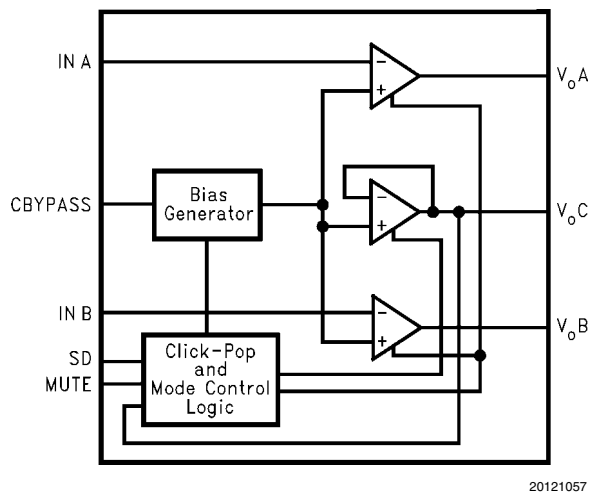
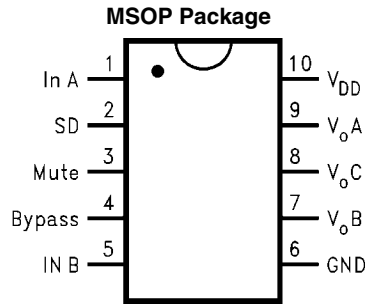

FIGURE 1. Block Diagram

Connection Diagrams



20121058

Top View
Order Number LM4924MM
See NS Package Number MUB10A for MSOP

MSOP Marking

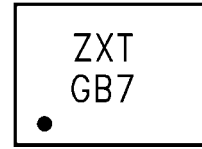

20121006

Z - Plant Code
X - Date Code
T - Die Traceability
G - Boomer Family
B7 - LM4924MM

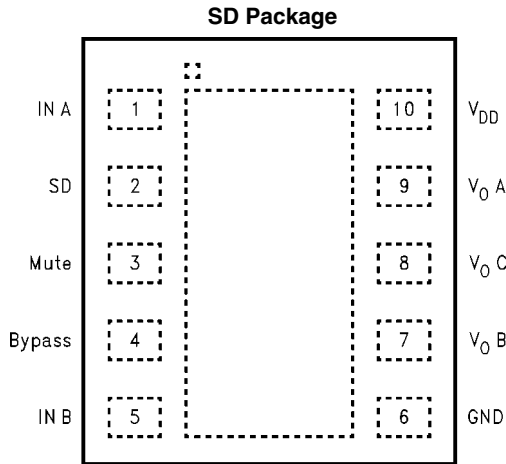

20121052

Top View
Order Number LM4924SD
See NS Package Number SDA10A

SD Marking

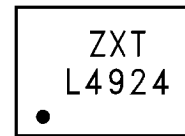

20121007

Z - Plant Code
X - Date Code
T - Die Traceability
Bottom Line - Part Number

Typical Connections

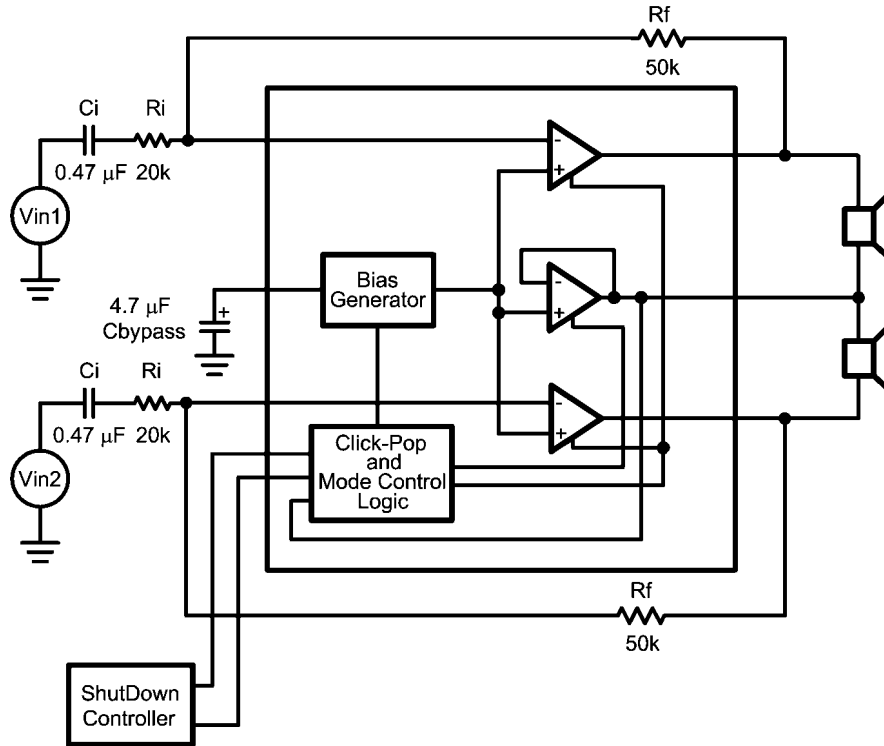

20121059

FIGURE 2. Typical OCL Output Configuration Circuit

Absolute Maximum Ratings (Note 1)

If Military/Aerospace specified devices are required, please contact the National Semiconductor Sales Office/Distributors for availability and specifications.

Supply Voltage	3.8V
Storage Temperature	-65°C to +150°C
Input Voltage	-0.3V to $V_{DD} + 0.3V$
Power Dissipation (Note 2)	Internally limited
ESD Susceptibility (Note 3)	2000V
ESD Susceptibility on pin 7, 8, and 9 (Note 3)	2kV
ESD Susceptibility (Note 4)	200V
Junction Temperature	150°C
Solder Information	

Small Outline Package Vapor Phase (60sec)	215°C
Infrared (15 sec)	220°C
See AN-450 "Surface Mounting and their Effects on Product Reliability" for other methods of soldering surface mount devices.	
Thermal Resistance	
θ_{JA} (typ) MUB10A	175°C/W
θ_{JA} (typ) SDA10A	73°C/W

Operating Ratings

Temperature Range	$T_{MIN} \leq T_A \leq T_{MAX}$	-40°C $\leq T_A \leq$ +85°C
Supply Voltage		$1.5V \leq V_{DD} \leq 3.6V$

Electrical Characteristics $V_{DD} = 3.0V$ (Notes 1, 5)

The following specifications apply for the circuit shown in Figure 2, unless otherwise specified. $A_V = 2.5$, $R_L = 16\Omega$. Limits apply for $T_A = 25^\circ\text{C}$.

Symbol	Parameter	Conditions	LM4924		Units (Limits)
			Typical (Note 6)	Limit (Note 7)	
I_{DD}	Quiescent Power Supply Current	$V_{IN} = 0V$, $I_O = 0A$, $R_L = \infty$ (Note 8)	1.5	1.9	mA (max)
I_{SD}	Shutdown Current	$V_{SHUTDOWN} = GND$	0.1	1	μA (max)
V_{OS}	Output Offset Voltage		1	10	mV (max)
P_O	Output Power (Note 9)	$f = 1\text{kHz}$, per channel OCL (Figure 2), THD+N = 1%	40	30	mW (min)
V_{NO}	Output Voltage Noise	20Hz to 20kHz, A-weighted, Figure 2	13		μV_{RMS}
THD		$P_O = 10\text{mW}$	0.1	0.5	%
Crosstalk		Freq = 1kHz	45	35	dB (min)
PSRR	Power Supply Rejection Ratio	$V_{RIPPLE} = 200\text{mV}_{P-P}$ sine wave Freq = 100Hz, OCL	66	58	dB (min)
$T_{WAKE-UP}$	Wake-Up Time	$1.5V \leq V_{DD} \leq 3.6V$, Fig 2	230		msec
V_{IH}	Control Logic High	$1.5V \leq V_{DD} \leq 3.6V$		$0.7V_{DD}$	V (min)
V_{IL}	Control Logic Low	$1.5V \leq V_{DD} \leq 3.6V$		$0.3V_{DD}$	V (max)
Mute Attenuation		$1V_{PP}$ Reference, $R_{IN} = 20k$, $R_{FB} = 50k$	90	70	dB

Electrical Characteristics $V_{DD} = 1.8V$ (Notes 1, 5)

The following specifications apply for the circuit shown in Figure 2, unless otherwise specified. $A_V = 2.5$, $R_L = 16\Omega$. Limits apply for $T_A = 25^\circ\text{C}$.

Symbol	Parameter	Conditions	LM4924		Units (Limits)
			Typical (Note 6)	Limit (Note 7)	
I_{DD}	Quiescent Power Supply Current	$V_{IN} = 0V$, $I_O = 0A$, $R_L = \infty$ (Note 8)	1.4		mA (max)
I_{SD}	Shutdown Current	$V_{SHUTDOWN} = GND$	0.1		μA (max)
V_{OS}	Output Offset Voltage		1		mV (max)
P_O	Output Power (Note 9)	$f = 1\text{kHz}$ OCL Per channel, Fig. 2, Freq = 1kHz THD+N = 1%	10		mW
V_{NO}	Output Voltage Noise	20Hz to 20kHz, A-weighted, Figure 2	10		μV_{RMS}
THD		$P_O = 5\text{mW}$	0.1		%
Crosstalk		Freq = 1kHz	45		dB (min)

Symbol	Parameter	Conditions	LM4924		Units (Limits)
			Typical (Note 6)	Limit (Note 7)	
PSRR	Power Supply Rejection Ratio	$V_{\text{RIPPLE}} = 200\text{mV}_{\text{P-P}}$ sine wave			
		Freq = 100Hz, OCL	66		dB

Note 1: Absolute Maximum Ratings indicate limits beyond which damage to the device may occur. Operating Ratings indicate conditions for which the device is functional, but do not guarantee specific performance limits. Electrical Characteristics state DC and AC electrical specifications under particular test conditions which guarantee specific performance limits. This assumes that the device is within the Operating Ratings. Specifications are not guaranteed for parameters where no limit is given, however, the typical value is a good indication of device performance.

Note 2: The maximum power dissipation is dictated by T_{JMAX} , θ_{JA} , and the ambient temperature T_{A} and must be derated at elevated temperatures. The maximum allowable power dissipation is $P_{\text{DMAX}} = (T_{\text{JMAX}} - T_{\text{A}})/\theta_{\text{JA}}$. For the LM4924, $T_{\text{JMAX}} = 150^{\circ}\text{C}$. For the θ_{JA} s, please see the Application Information section or the Absolute Maximum Ratings section.

Note 3: Human body model, 100pF discharged through a 1.5k Ω resistor.

Note 4: Machine model, 220pF–240pF discharged through all pins.

Note 5: All voltages are measured with respect to the ground (GND) pins unless otherwise specified.

Note 6: Typicals are measured at 25 $^{\circ}\text{C}$ and represent the parametric norm.

Note 7: Datasheet min/max specification limits are guaranteed by design, test, or statistical analysis.

Note 8: The quiescent power supply current depends on the offset voltage when a practical load is connected to the amplifier.

Note 9: Output power is measured at the device terminals.

Typical Performance Characteristics

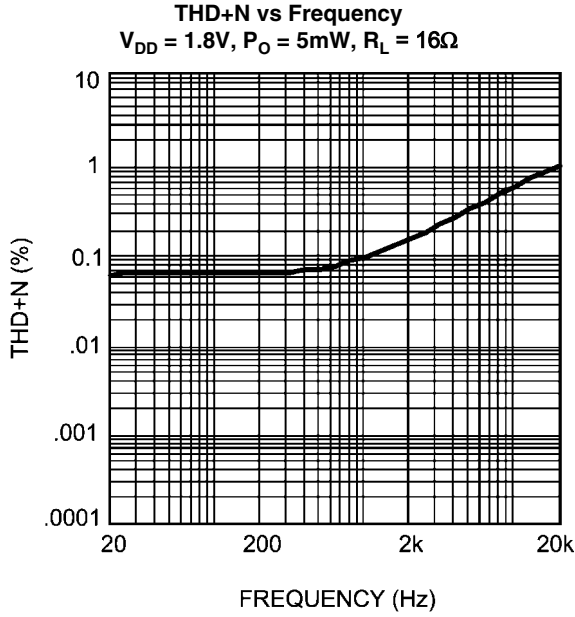

20121013

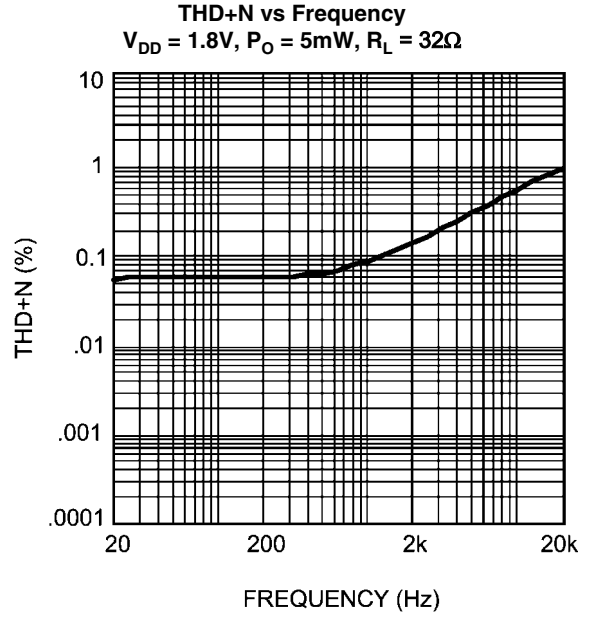

20121014

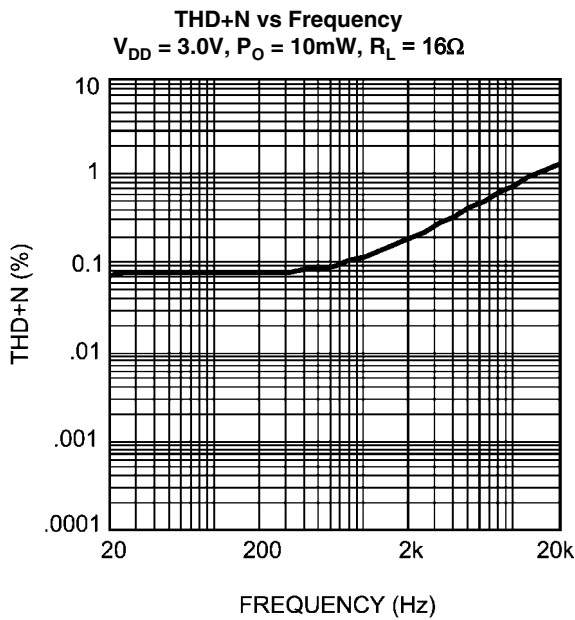

20121015

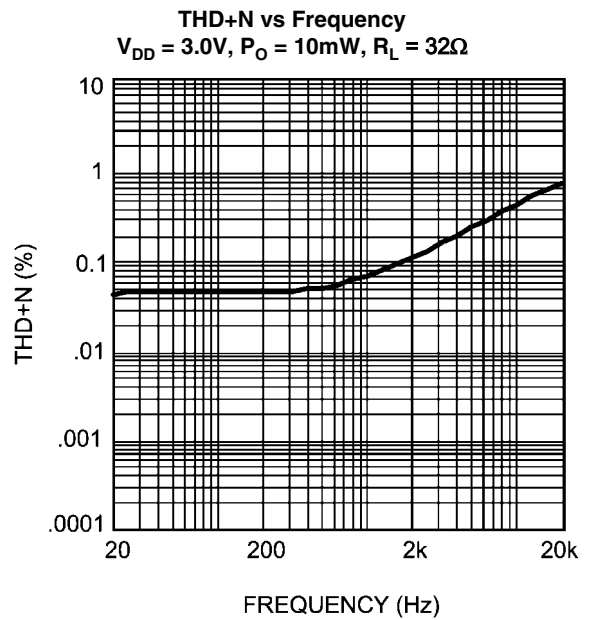

20121016

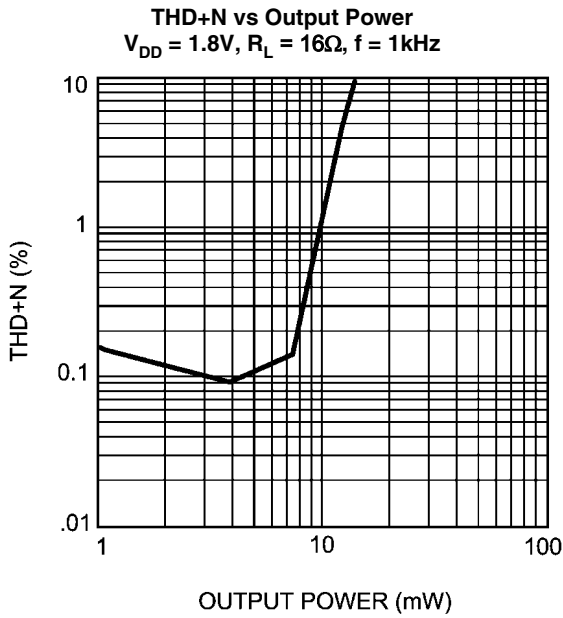

20121017

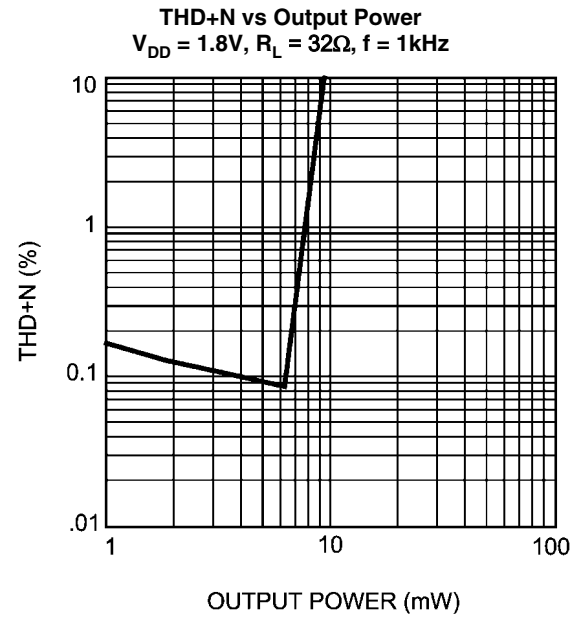

20121018

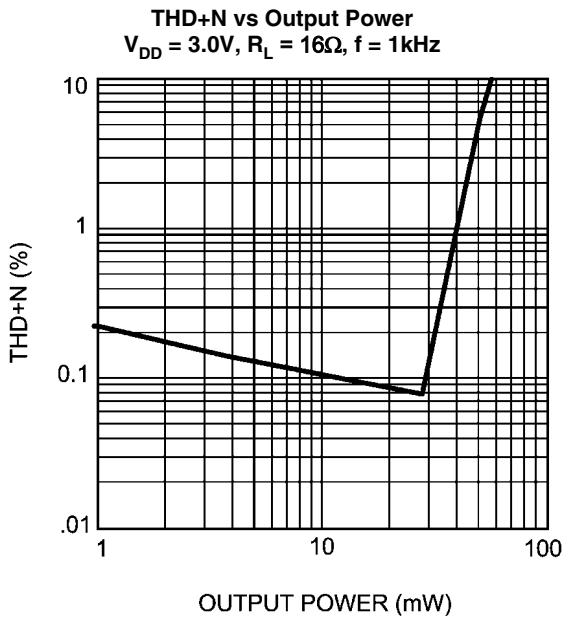

20121019

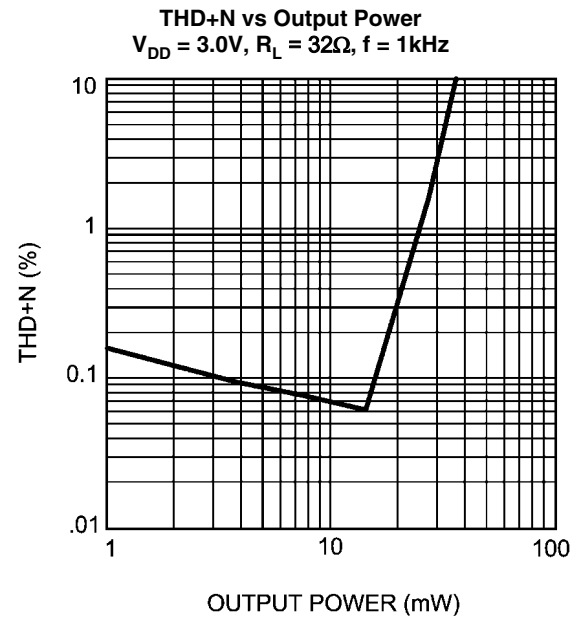

20121020

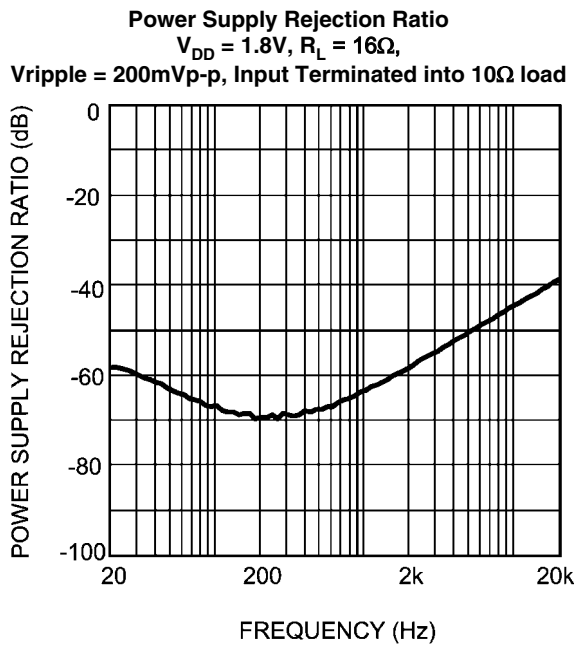

20121011

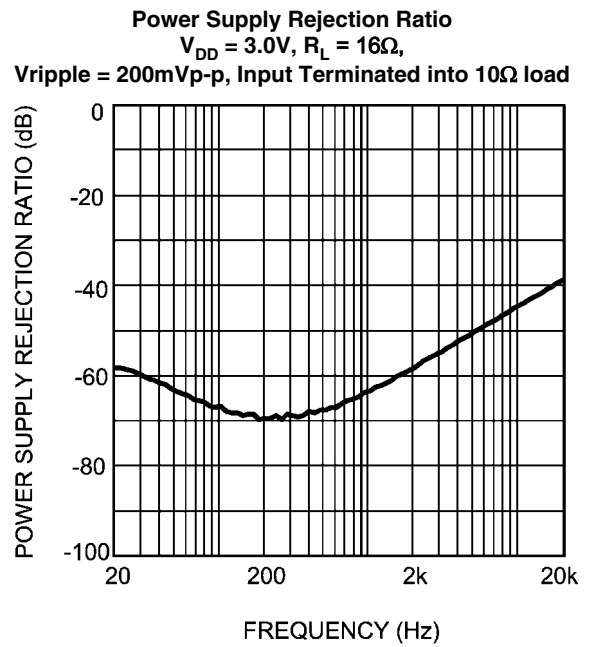

20121012

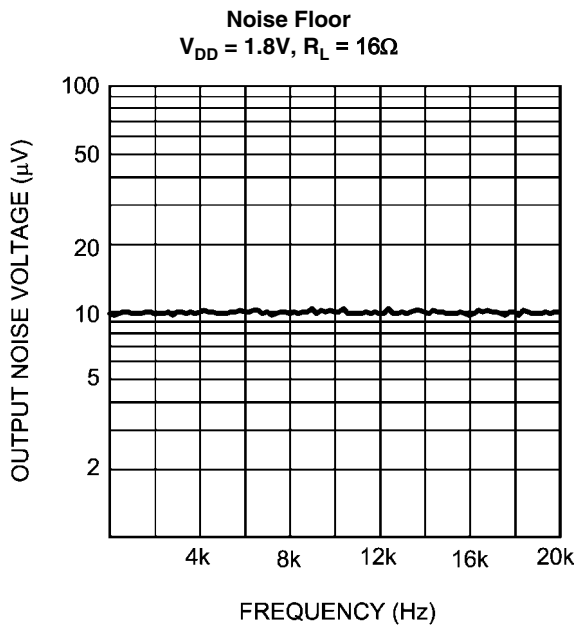

20121009

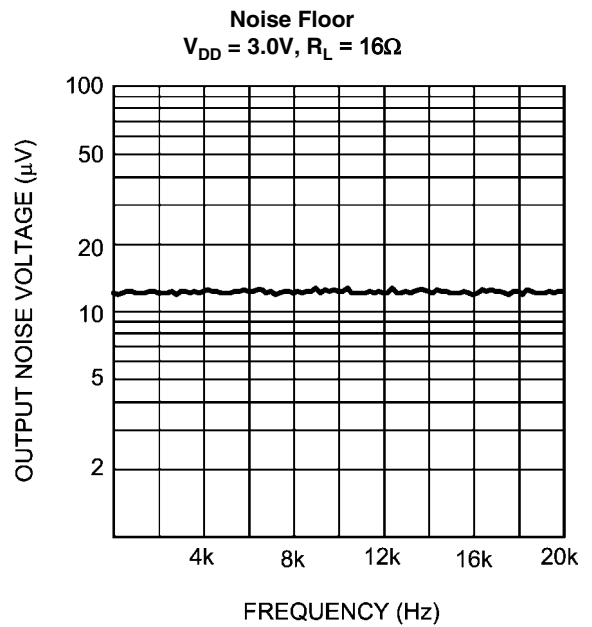

20121010

Channel Separation
 $R_L = 16\Omega$

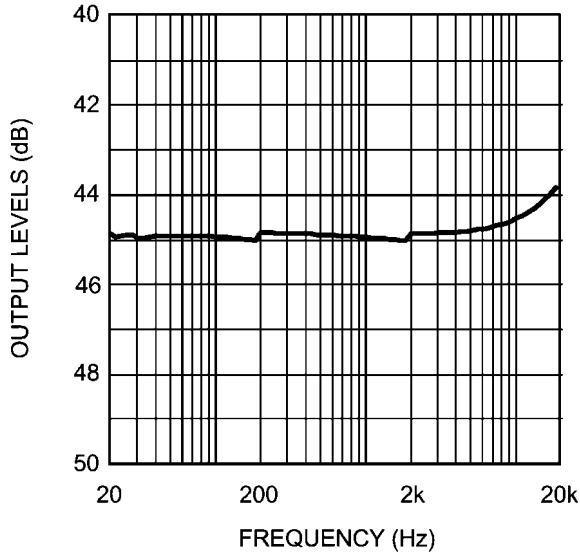

Output Power vs Load Resistance
 $f = 1\text{kHz}$, from top to bottom:
 $V_{DD} = 3.0\text{V}, 10\%\text{THD+N}; V_{DD} = 3.0\text{V}, 1\%\text{THD+N}$
 $V_{DD} = 1.8\text{V}, 10\%\text{THD+N}; V_{DD} = 1.8\text{V}, 1\%\text{THD+N}$

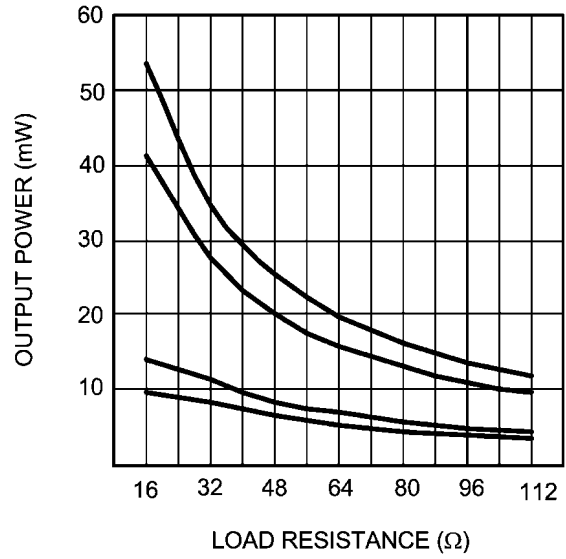

Output Power vs Supply Voltage
 $R_L = 16\Omega$, from top to bottom:
 $\text{THD+N} = 10\%; \text{THD+N} = 1\%$

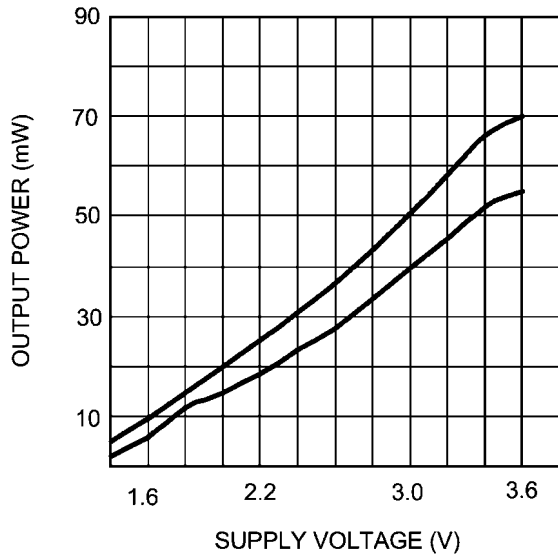

Output Power vs Supply Voltage
 $R_L = 32\Omega$, from top to bottom:
 $\text{THD+N} = 10\%; \text{THD+N} = 1\%$

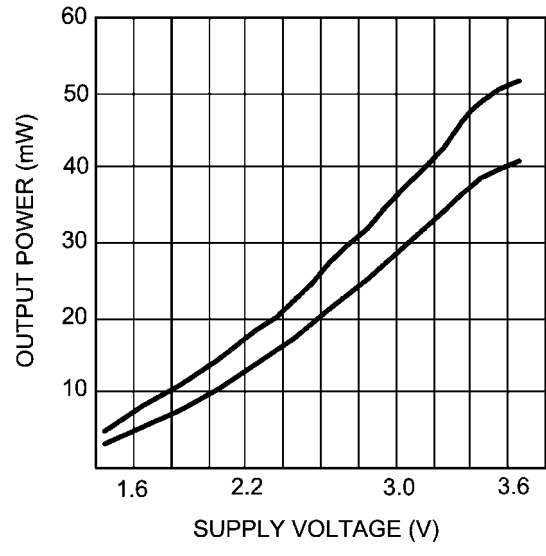

Power Dissipation vs Output Power
 $V_{DD} = 1.8V$, $f = 1kHz$, from top to bottom:
 $R_L = 16\Omega$; $R_L = 32\Omega$

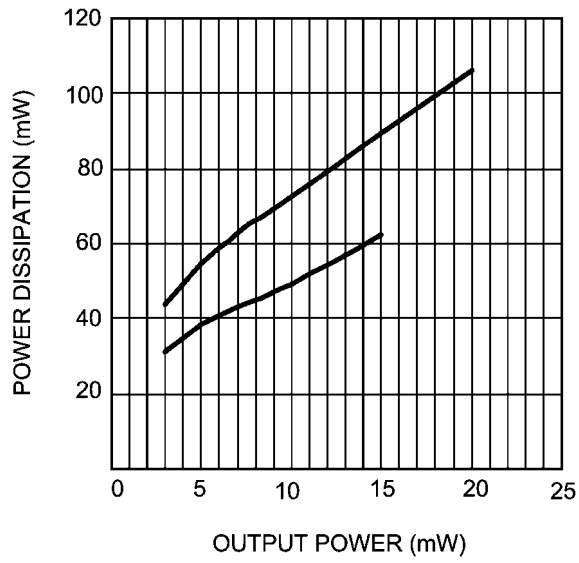

20121024

Power Dissipation vs Output Power
 $V_{DD} = 3.0V$, $f = 1kHz$, from top to bottom:
 $R_L = 16\Omega$; $R_L = 32\Omega$

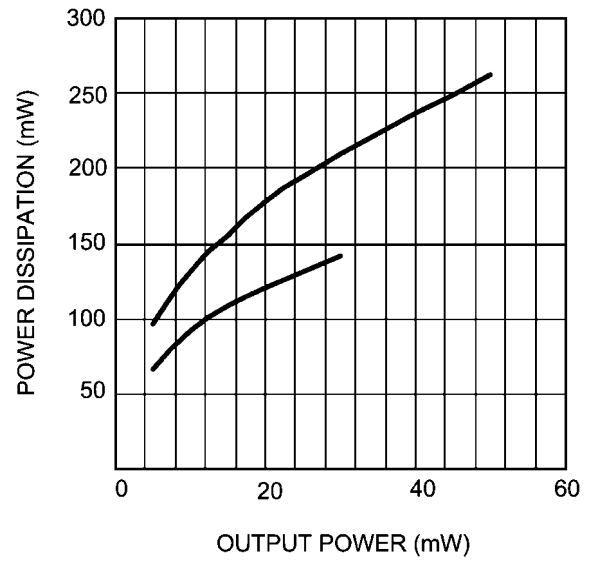

20121025

Supply Current vs Supply Voltage

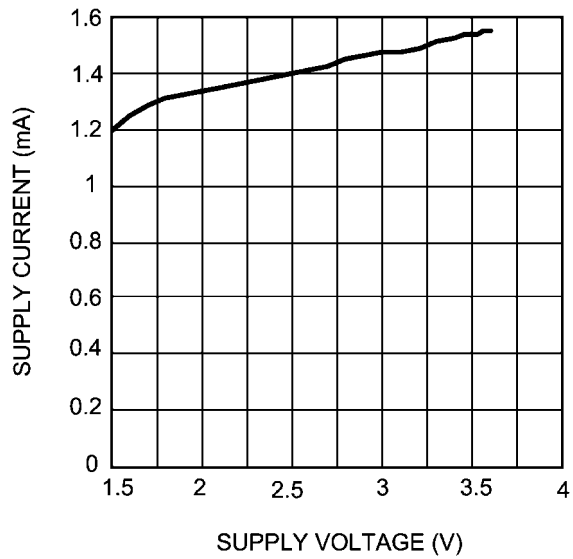

20121026

Application Information

ELIMINATING OUTPUT COUPLING CAPACITORS

Typical single-supply audio amplifiers that drive single-ended (SE) headphones use a coupling capacitor on each SE output. This output coupling capacitor blocks the half-supply voltage to which the output amplifiers are typically biased and couples the audio signal to the headphones. The signal return to circuit ground is through the headphone jack's sleeve.

The LM4924 eliminates these output coupling capacitors. V_{OC} is internally configured to apply a $1/2V_{DD}$ bias voltage to a stereo headphone jack's sleeve. This voltage matches the quiescent voltage present on the V_{OA} and V_{OB} outputs that drive the headphones. The headphones operate in a manner similar to a bridge-tied-load (BTL). The same DC voltage is applied to both headphone speaker terminals. This results in no net DC current flow through the speaker. AC current flows through a headphone speaker as an audio signal's output amplitude increases on the speaker's terminal.

The headphone jack's sleeve is not connected to circuit ground. Using the headphone output jack as a line-level output will place the LM4924's bandgap $1/2V_{DD}$ bias on a plug's sleeve connection. This presents no difficulty when the external equipment uses capacitively coupled inputs. For the very small minority of equipment that is DC-coupled, the LM4924 monitors the current supplied by the amplifier that drives the headphone jack's sleeve. If this current exceeds $500mA_{PK}$, the amplifier is shutdown, protecting the LM4924 and the external equipment.

BYPASS CAPACITOR VALUE SELECTION

Besides minimizing the input capacitor size, careful consideration should be paid to value of C_{BYPASS} , the capacitor connected to the BYPASS pin. Since C_{BYPASS} determines how fast the LM4924 settles to quiescent operation, its value is critical when minimizing turn-on pops. The slower the LM4924's outputs ramp to their quiescent DC voltage (nominally $V_{DD}/2$), the smaller the turn-on pop. Choosing C_B equal to $4.7\mu F$ along with a small value of C_i (in the range of $0.1\mu F$ to $0.47\mu F$), produces a click-less and pop-less shutdown function. As discussed above, choosing C_i no larger than necessary for the desired bandwidth helps minimize clicks and pops. This ensures that output transients are eliminated when power is first applied or the LM4924 resumes operation after shutdown.

OPTIMIZING CLICK AND POP REDUCTION PERFORMANCE

The LM4924 contains circuitry that eliminates turn-on and shutdown transients ("clicks and pops"). For this discussion, turn-on refers to either applying the power supply voltage or when the micro-power shutdown mode is deactivated.

As the $V_{DD}/2$ voltage present at the BYPASS pin ramps to its final value, the LM4924's internal amplifiers are configured as unity gain buffers. An internal current source charges the capacitor connected between the BYPASS pin and GND in a controlled, linear manner. Ideally, the input and outputs track the voltage applied to the BYPASS pin. The gain of the internal amplifiers remains unity until the voltage on the bypass pin reaches $V_{DD}/2$. As soon as the voltage on the bypass pin is stable, the device becomes fully operational and the amplifier outputs are reconnected to their respective output pins. Although the BYPASS pin current cannot be modified, changing the size of C_{BYPASS} alters the device's turn-on time. There is a linear relationship between the size of C_{BYPASS} and the

turn-on time. Here are some typical turn-on times for various values of C_{BYPASS} .

AMPLIFIER CONFIGURATION EXPLANATION

As shown in *Figure 1*, the LM4924 has three operational amplifiers internally. Two of the amplifier's have externally configurable gain while the other amplifier is internally fixed at the bias point acting as a unity-gain buffer. The closed-loop gain of the two configurable amplifiers is set by selecting the ratio of R_f to R_i . Consequently, the gain for each channel of the IC is

$$A_V = -(R_f/R_i)$$

By driving the loads through outputs V_{O1} and V_{O2} with V_{O3} acting as a buffered bias voltage the LM4924 does not require output coupling capacitors. The typical single-ended amplifier configuration where one side of the load is connected to ground requires large, expensive output coupling capacitors.

A configuration such as the one used in the LM4924 has a major advantage over single supply, single-ended amplifiers. Since the outputs V_{O1} , V_{O2} , and V_{O3} are all biased at $1/2 V_{DD}$, no net DC voltage exists across each load. This eliminates the need for output coupling capacitors that are required in a single-supply, single-ended amplifier configuration. Without output coupling capacitors in a typical single-supply, single-ended amplifier, the bias voltage is placed across the load resulting in both increased internal IC power dissipation and possible loudspeaker damage.

POWER DISSIPATION

Power dissipation is a major concern when designing a successful amplifier. A direct consequence of the increased power delivered to the load by a bridge amplifier is an increase in internal power dissipation. The maximum power dissipation for a given application can be derived from the power dissipation graphs or from Equation 1.

$$P_{DMAX} = 4(V_{DD})^2 / (\pi^2 R_L) \quad (1)$$

It is critical that the maximum junction temperature T_{JMAX} of $150^\circ C$ is not exceeded. Since the typical application is for headphone operation (16Ω impedance) using a 3.3V supply the maximum power dissipation is only 138mW. Therefore, power dissipation is not a major concern.

POWER SUPPLY BYPASSING

As with any amplifier, proper supply bypassing is important for low noise performance and high power supply rejection. The capacitor location on the power supply pins should be as close to the device as possible.

Typical applications employ a 3.0V regulator with $10\mu F$ tantalum or electrolytic capacitor and a ceramic bypass capacitor which aid in supply stability. This does not eliminate the need for bypassing the supply nodes of the LM4924. A bypass capacitor value in the range of $0.1\mu F$ to $1\mu F$ is recommended for C_S .

MICRO POWER SHUTDOWN

The voltage applied to the $\overline{SHUTDOWN}$ pin controls the LM4924's shutdown function. Activate micro-power shutdown by applying a logic-low voltage to the SHUTDOWN pin. When active, the LM4924's micro-power shutdown feature turns off

the amplifier's bias circuitry, reducing the supply current. The trigger point is 0.4V (max) for a logic-low level, and 1.5V (min) for a logic-high level. The low 0.1µA (typ) shutdown current is achieved by applying a voltage that is as near as ground as possible to the SHUTDOWN pin. A voltage that is higher than ground may increase the shutdown current.

There are a few ways to control the micro-power shutdown. These include using a single-pole, single-throw switch, a microprocessor, or a microcontroller. When using a switch, connect an external 100kΩ pull-up resistor between the SHUTDOWN pin and V_{DD}. Connect the switch between the SHUTDOWN pin and ground. Select normal amplifier operation by opening the switch. Closing the switch connects the SHUTDOWN pin to ground, activating micro-power shutdown. The switch and resistor guarantee that the SHUTDOWN pin will not float. This prevents unwanted state changes. In a system with a microprocessor or microcontroller, use a digital output to apply the control voltage to the SHUTDOWN pin. Driving the SHUTDOWN pin with active circuitry eliminates the pull-up resistor.

SELECTING EXTERNAL COMPONENTS

Selecting proper external components in applications using integrated power amplifiers is critical to optimize device and system performance. While the LM4924 is tolerant of external component combinations, consideration to component values must be used to maximize overall system quality.

The LM4924 is unity-gain stable which gives the designer maximum system flexibility. The LM4924 should be used in low gain configurations to minimize THD+N values, and maximize the signal to noise ratio. Low gain configurations require large input signals to obtain a given output power. Input signals equal to or greater than 1V_{rms} are available from sources such as audio codecs. Very large values should not be used for the gain-setting resistors. Values for R_i and R_f should be less than 1MΩ. Please refer to the section, **Audio Power Amplifier Design**, for a more complete explanation of proper gain selection

Besides gain, one of the major considerations is the closed-loop bandwidth of the amplifier. The input coupling capacitor, C_i, forms a first order high pass filter which limits low frequency response. This value should be chosen based on needed frequency response and turn-on time.

SELECTION OF INPUT CAPACITOR SIZE

Amplifying the lowest audio frequencies requires a high value input coupling capacitor, C_i. A high value capacitor can be expensive and may compromise space efficiency in portable designs. In many cases, however, the headphones used in portable systems have little ability to reproduce signals below 60Hz. Applications using headphones with this limited frequency response reap little improvement by using a high value input capacitor.

In addition to system cost and size, turn-on time is affected by the size of the input coupling capacitor C_i. A larger input coupling capacitor requires more charge to reach its quiescent DC voltage. This charge comes from the output via the feedback. Thus, by minimizing the capacitor size based on necessary low frequency response, turn-on time can be minimized. A small value of C_i (in the range of 0.1µF to 0.39µF), is recommended.

USING EXTERNAL POWERED SPEAKERS

The LM4924 is designed specifically for headphone operation. Often the headphone output of a device will be used to drive external powered speakers. The LM4924 has a differ-

ential output to eliminate the output coupling capacitors. The result is a headphone jack sleeve that is connected to V_{O3} instead of GND. For powered speakers that are designed to have single-ended signals at the input, the click and pop circuitry will not be able to eliminate the turn-on/turn-off click and pop. Unless the inputs to the powered speakers are fully differential the turn-on/turn-off click and pop will be very large.

AUDIO POWER AMPLIFIER DESIGN

A 30mW/32Ω Audio Amplifier

Given:

Power Output	30mWrms
Load Impedance	32Ω
Input Level	1Vrms
Input Impedance	20kΩ

A designer must first determine the minimum supply rail to obtain the specified output power. By extrapolating from the Output Power vs Supply Voltage graphs in the **Typical Performance Characteristics** section, the supply rail can be easily found.

Since 3.3V is a standard supply voltage in most applications, it is chosen for the supply rail in this example. Extra supply voltage creates headroom that allows the LM4924 to reproduce peaks in excess of 30mW without producing audible distortion. At this time, the designer must make sure that the power supply choice along with the output impedance does no violate the conditions explained in the **Power Dissipation** section.

Once the power dissipation equations have been addressed, the required differential gain can be determined from Equation 2.

$$A_V \geq \sqrt{(P_O R_L)} / (V_{IN}) = V_{orms} / V_{inrms} \quad (2)$$

From Equation 2, the minimum A_V is 0.98; use A_V = 1. Since the desired input impedance is 20kΩ, and with A_V equal to 1, a ratio of 1:1 results from Equation 1 for R_f to R_i. The values are chosen with R_i = 20kΩ and R_f = 20kΩ.

The last step in this design example is setting the amplifier's -3dB frequency bandwidth. To achieve the desired ±0.25dB pass band magnitude variation limit, the low frequency response must extend to at least one-fifth the lower bandwidth limit and the high frequency response must extend to at least five times the upper bandwidth limit. The gain variation for both response limits is 0.17dB, well within the ±0.25dB desired limit. The results are an

$$f_L = 100\text{Hz}/5 = 20\text{Hz} \quad (3)$$

and an

$$f_H = 20\text{kHz} \times 5 = 100\text{kHz} \quad (4)$$

As mentioned in the **Selecting Proper External Components** section, R_i and C_i create a highpass filter that sets the amplifier's lower bandpass frequency limit. Find the coupling capacitor's value using Equation (3).

$$C_i \geq 1 / (2\pi R_i f_L) \quad (5)$$

The result is

$$1/(2\pi \cdot 20\text{k}\Omega \cdot 20\text{Hz}) = 0.397\mu\text{F}$$

Use a 0.39 μF capacitor, the closest standard value.

The high frequency pole is determined by the product of the desired frequency pole, f_H , and the differential gain, A_V . With

HIGHER GAIN AUDIO AMPLIFIER

an $A_V = 1$ and $f_H = 100\text{kHz}$, the resulting GBWP = 100kHz which is much smaller than the LM4924 GBWP of 11MHz. This figure displays that if a designer has a need to design an amplifier with higher differential gain, the LM4924 can still be used without running into bandwidth limitations.

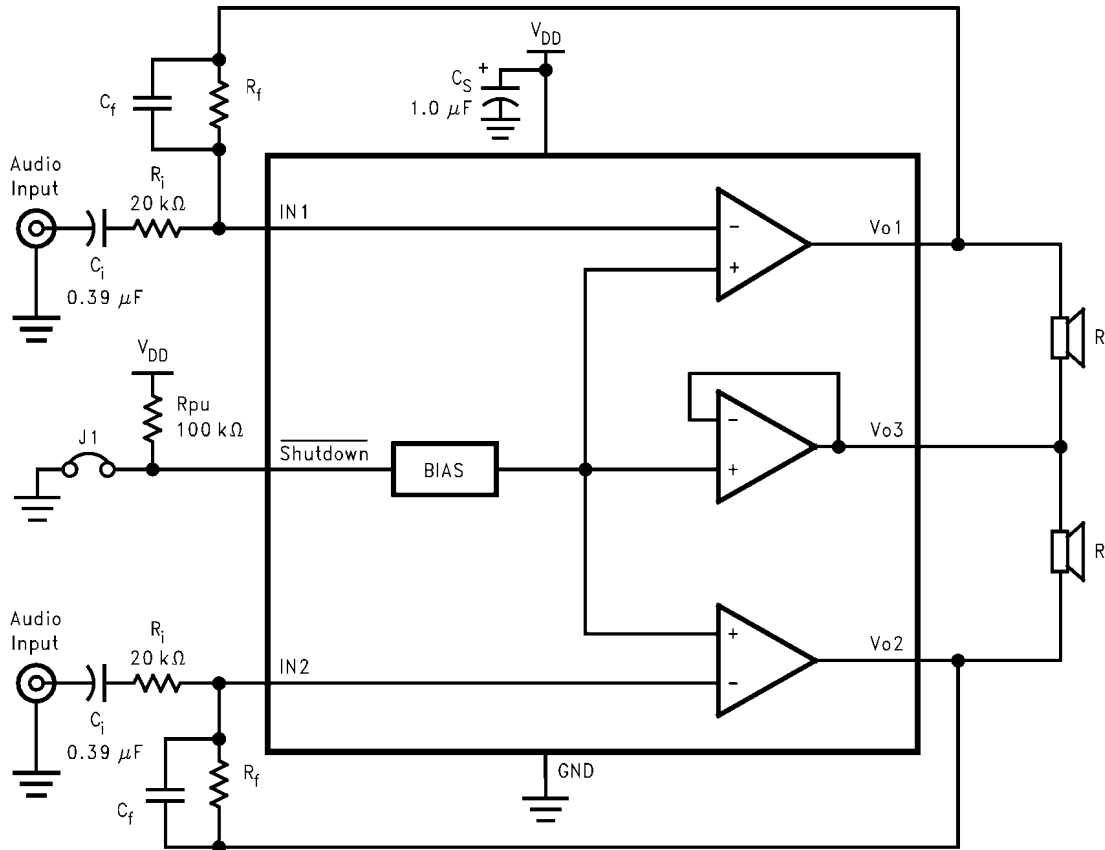

20121029

FIGURE 3.

The LM4924 is unity-gain stable and requires no external components besides gain-setting resistors, input coupling capacitors, and proper supply bypassing in the typical application. However, if a very large closed-loop differential gain is required, a feedback capacitor (C_f) may be needed to bandwidth limit the amplifier. This feedback capacitor creates a low pass filter that eliminates possible high frequency oscillations.

REFERENCE DESIGN BOARD and LAYOUT GUIDELINES MSOP & SD BOARDS

Care should be taken when calculating the -3dB frequency in that an incorrect combination of R_f and C_f will cause frequency response roll off before 20kHz. A typical combination of feedback resistor and capacitor that will not produce audio band high frequency roll off is $R_f = 20\text{k}\Omega$ and $C_f = 25\text{pF}$. These components result in a -3dB point of approximately 320kHz.

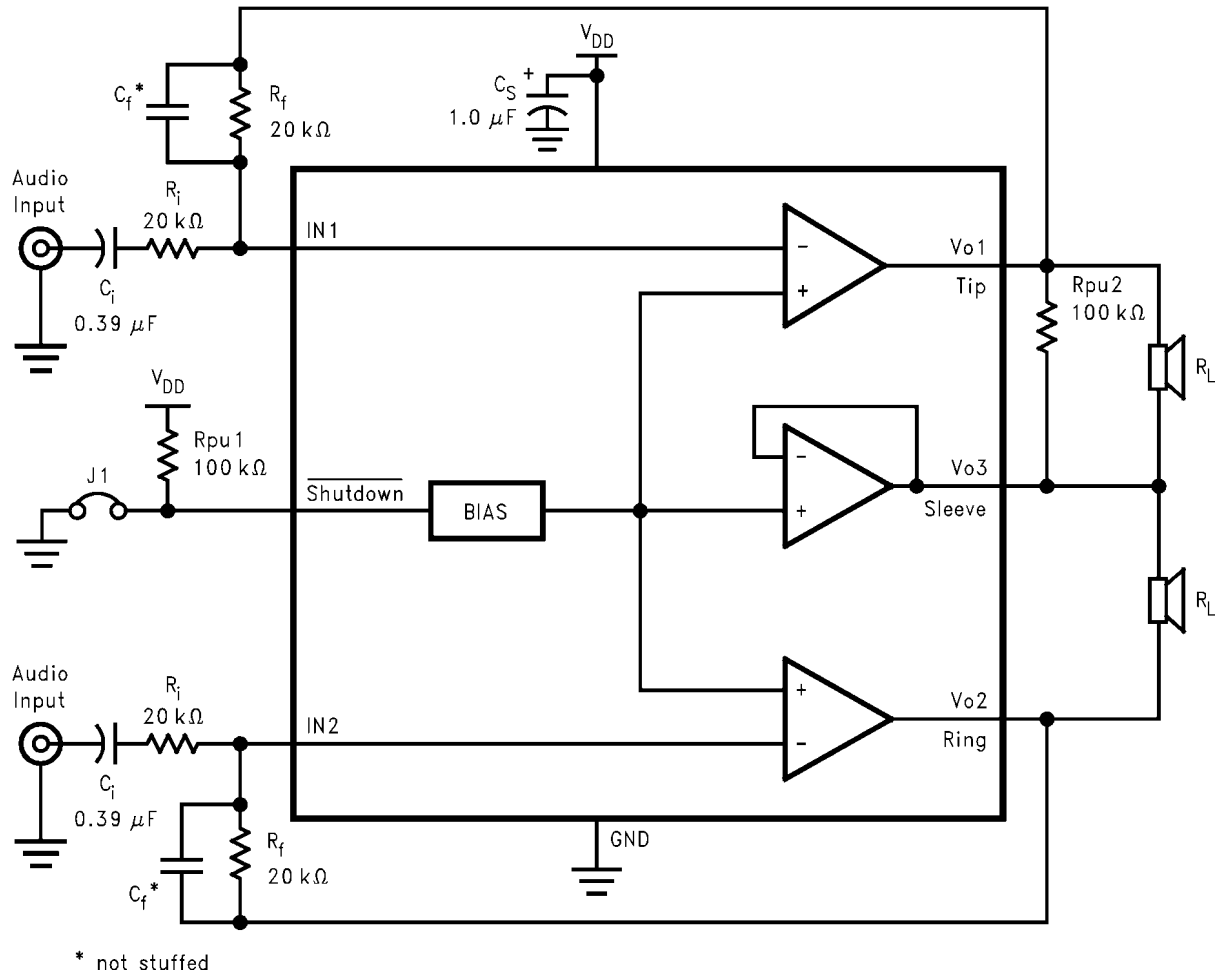

20121030

FIGURE 4.

(Note: R_{pu2} is not required. It is used for test measurement purposes only.)

PCB LAYOUT GUIDELINES

This section provides practical guidelines for mixed signal PCB layout that involves various digital/analog power and ground traces. Designers should note that these are only "rule-of-thumb" recommendations and the actual results will depend heavily on the final layout.

Minimization of THD

PCB trace impedance on the power, ground, and all output traces should be minimized to achieve optimal THD performance. Therefore, use PCB traces that are as wide as possible for these connections. As the gain of the amplifier is increased, the trace impedance will have an ever increasing adverse affect on THD performance. At unity-gain (0dB) the parasitic trace impedance effect on THD performance is reduced but still a negative factor in the THD performance of the LM4924 in a given application.

GENERAL MIXED SIGNAL LAYOUT RECOMMENDATION

Power and Ground Circuits

For two layer mixed signal design, it is important to isolate the digital power and ground trace paths from the analog power and ground trace paths. Star trace routing techniques (bringing individual traces back to a central point rather than daisy chaining traces together in a serial manner) can greatly enhance low level signal performance. Star trace routing refers

to using individual traces to feed power and ground to each circuit or even device. This technique will require a greater amount of design time but will not increase the final price of the board. The only extra parts required may be some jumpers.

Single-Point Power / Ground Connections

The analog power traces should be connected to the digital traces through a single point (link). A "PI-filter" can be helpful in minimizing high frequency noise coupling between the analog and digital sections. Further, place digital and analog power traces over the corresponding digital and analog ground traces to minimize noise coupling.

Placement of Digital and Analog Components

All digital components and high-speed digital signal traces should be located as far away as possible from analog components and circuit traces.

Avoiding Typical Design / Layout Problems

Avoid ground loops or running digital and analog traces parallel to each other (side-by-side) on the same PCB layer. When traces must cross over each other do it at 90 degrees. Running digital and analog traces at 90 degrees to each other from the top to the bottom side as much as possible will minimize capacitive noise coupling and cross talk.

Physical Dimensions inches (millimeters) unless otherwise noted

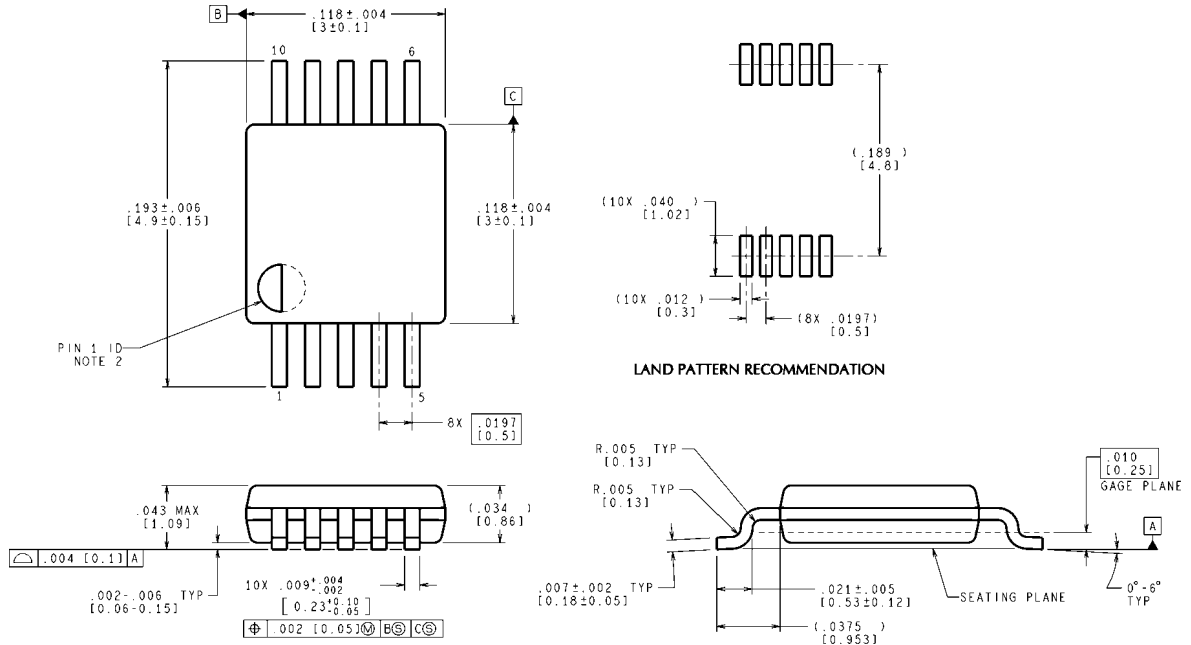

CONTROLLING DIMENSION IS INCH
VALUES IN [] ARE MILLIMETERS
DIMENSIONS IN () FOR REFERENCE ONLY

MUB10A (Rev B)

MSOP Package
Order Number LM4924MM
NS Package Number MUB10A

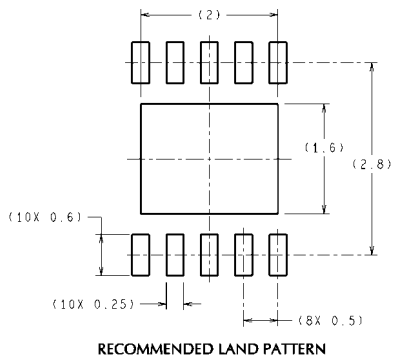

DIMENSIONS ARE IN MILLIMETERS
DIMENSIONS IN () FOR REFERENCE ONLY

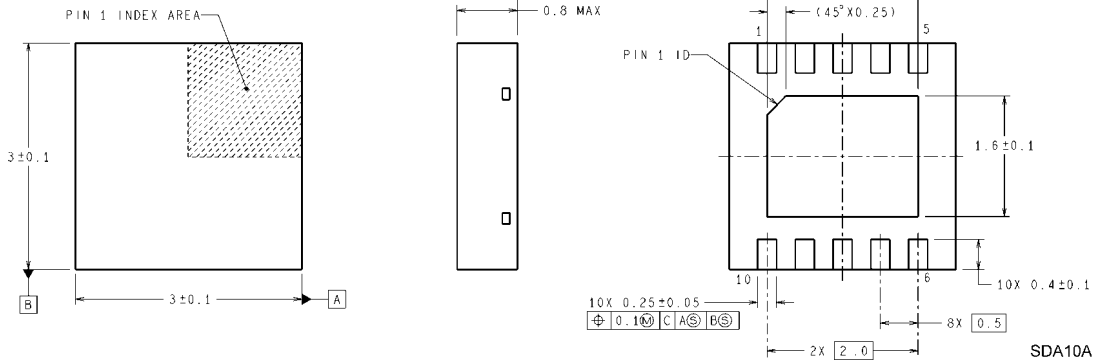

SD Package
Order Number LM4924SD
NS Package Number SDA10A

SDA10A (Rev A)

Notes

LM4924

Notes

For more National Semiconductor product information and proven design tools, visit the following Web sites at:

Products		Design Support	
Amplifiers	www.national.com/amplifiers	WEBENCH® Tools	www.national.com/webench
Audio	www.national.com/audio	App Notes	www.national.com/appnotes
Clock and Timing	www.national.com/timing	Reference Designs	www.national.com/refdesigns
Data Converters	www.national.com/adc	Samples	www.national.com/samples
Interface	www.national.com/interface	Eval Boards	www.national.com/evalboards
LVDS	www.national.com/lvds	Packaging	www.national.com/packaging
Power Management	www.national.com/power	Green Compliance	www.national.com/quality/green
Switching Regulators	www.national.com/switchers	Distributors	www.national.com/contacts
LDOs	www.national.com/lido	Quality and Reliability	www.national.com/quality
LED Lighting	www.national.com/led	Feedback/Support	www.national.com/feedback
Voltage Reference	www.national.com/vref	Design Made Easy	www.national.com/easy
PowerWise® Solutions	www.national.com/powerwise	Solutions	www.national.com/solutions
Serial Digital Interface (SDI)	www.national.com/sdi	Mil/Aero	www.national.com/milaero
Temperature Sensors	www.national.com/tempensors	SolarMagic™	www.national.com/solarmagic
Wireless (PLL/VCO)	www.national.com/wireless	PowerWise® Design University	www.national.com/training

THE CONTENTS OF THIS DOCUMENT ARE PROVIDED IN CONNECTION WITH NATIONAL SEMICONDUCTOR CORPORATION ("NATIONAL") PRODUCTS. NATIONAL MAKES NO REPRESENTATIONS OR WARRANTIES WITH RESPECT TO THE ACCURACY OR COMPLETENESS OF THE CONTENTS OF THIS PUBLICATION AND RESERVES THE RIGHT TO MAKE CHANGES TO SPECIFICATIONS AND PRODUCT DESCRIPTIONS AT ANY TIME WITHOUT NOTICE. NO LICENSE, WHETHER EXPRESS, IMPLIED, ARISING BY ESTOPPEL OR OTHERWISE, TO ANY INTELLECTUAL PROPERTY RIGHTS IS GRANTED BY THIS DOCUMENT.

TESTING AND OTHER QUALITY CONTROLS ARE USED TO THE EXTENT NATIONAL DEEMS NECESSARY TO SUPPORT NATIONAL'S PRODUCT WARRANTY. EXCEPT WHERE MANDATED BY GOVERNMENT REQUIREMENTS, TESTING OF ALL PARAMETERS OF EACH PRODUCT IS NOT NECESSARILY PERFORMED. NATIONAL ASSUMES NO LIABILITY FOR APPLICATIONS ASSISTANCE OR BUYER PRODUCT DESIGN. BUYERS ARE RESPONSIBLE FOR THEIR PRODUCTS AND APPLICATIONS USING NATIONAL COMPONENTS. PRIOR TO USING OR DISTRIBUTING ANY PRODUCTS THAT INCLUDE NATIONAL COMPONENTS, BUYERS SHOULD PROVIDE ADEQUATE DESIGN, TESTING AND OPERATING SAFEGUARDS.

EXCEPT AS PROVIDED IN NATIONAL'S TERMS AND CONDITIONS OF SALE FOR SUCH PRODUCTS, NATIONAL ASSUMES NO LIABILITY WHATSOEVER, AND NATIONAL DISCLAIMS ANY EXPRESS OR IMPLIED WARRANTY RELATING TO THE SALE AND/OR USE OF NATIONAL PRODUCTS INCLUDING LIABILITY OR WARRANTIES RELATING TO FITNESS FOR A PARTICULAR PURPOSE, MERCHANTABILITY, OR INFRINGEMENT OF ANY PATENT, COPYRIGHT OR OTHER INTELLECTUAL PROPERTY RIGHT.

LIFE SUPPORT POLICY

NATIONAL'S PRODUCTS ARE NOT AUTHORIZED FOR USE AS CRITICAL COMPONENTS IN LIFE SUPPORT DEVICES OR SYSTEMS WITHOUT THE EXPRESS PRIOR WRITTEN APPROVAL OF THE CHIEF EXECUTIVE OFFICER AND GENERAL COUNSEL OF NATIONAL SEMICONDUCTOR CORPORATION. As used herein:

Life support devices or systems are devices which (a) are intended for surgical implant into the body, or (b) support or sustain life and whose failure to perform when properly used in accordance with instructions for use provided in the labeling can be reasonably expected to result in a significant injury to the user. A critical component is any component in a life support device or system whose failure to perform can be reasonably expected to cause the failure of the life support device or system or to affect its safety or effectiveness.

National Semiconductor and the National Semiconductor logo are registered trademarks of National Semiconductor Corporation. All other brand or product names may be trademarks or registered trademarks of their respective holders.

Copyright© 2009 National Semiconductor Corporation

For the most current product information visit us at www.national.com



National Semiconductor Americas Technical Support Center
 Email: support@nsc.com
 Tel: 1-800-272-9959

National Semiconductor Europe Technical Support Center
 Email: europe.support@nsc.com

National Semiconductor Asia Pacific Technical Support Center
 Email: ap.support@nsc.com

National Semiconductor Japan Technical Support Center
 Email: jpn.feedback@nsc.com