

### General Description

The AAT3125 USB On-the-Go (OTG) charge pump is a member of AnalogicTech's Total Power Management IC™ (TPMIC™) product family. The device integrates a high efficiency 1.5X fractional 100mA regulated charge pump for supplying  $V_{BUS}$  with the additional functions required for OTG devices (formerly known as dual role devices). Four voltage detectors monitor  $V_{BUS}$ , and a current source dedicated for  $V_{BUS}$  pulsing is provided for compliance with Session Request Protocol (SRP) as defined by the USB OTG Supplement.

The charge pump section uses a high efficiency fractional topology, with a high frequency 750kHz switching speed which enables the use of small capacitors (less than 3.3 $\mu$ F). The AAT3125 features extremely low quiescent current to extend battery run time. Additionally, the device integrates protection features such as under-voltage lockout, and output short circuit and thermal protection.

The AAT3125 is available in a Pb-free, surface mount QFN44-16 package and is rated over the -40°C to +85°C temperature range.

### Features

- $V_{IN}$  Range: 2.7V to 5.5V
- Regulated Fractional Charge Pump
- 100mA Output Current
- Reverse Load Protection
- Power Good Flag
- SRP Detection Flag
- SRP Ready Flag
- Output Short-Circuit and Thermal Protection
- Under-Voltage Protection
- Less than 1 $\mu$ A Consumed While Disabled
- Designed to Allow Operation with Output Capacitance as Low as 3.3 $\mu$ F
- 16-pin QFN44 Package
- -40°C to +85°C Temperature Range

### Applications

- Cell Phones
- Hand-Held Computers
- PDAs

### Typical Application

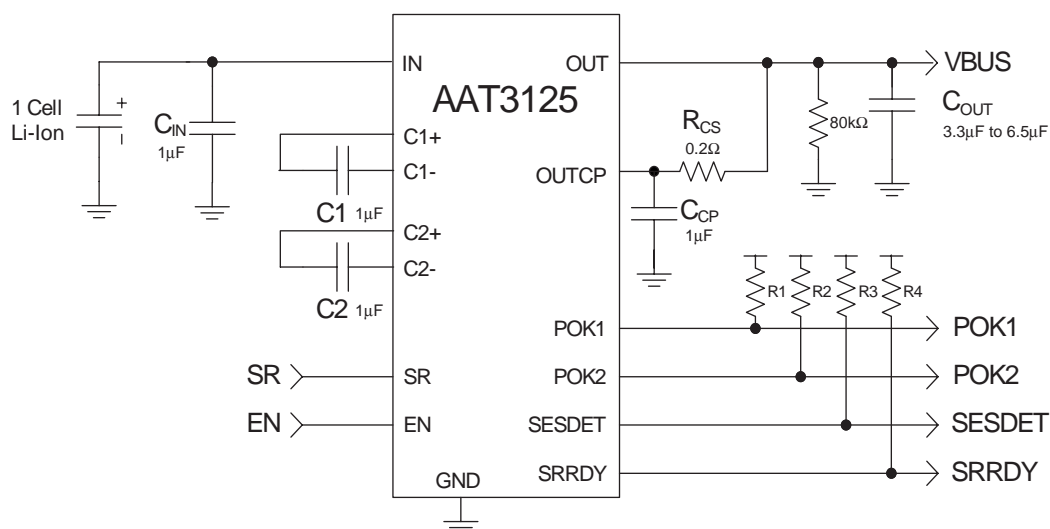

### Pin Descriptions

Pin #	Symbol	Function
1	POK1	Power OK 1. Open drain output with 4.0V voltage detector. When the OUT pin rises above the detected voltage (4.0V), POK1 will transition from low to high state. Similarly, when the output falls below 4.0V, POK1 will transition from high to low. A 10kΩ pull-up resistor is recommended.
2	POK2	Power OK 2. Open drain output with 4.4V voltage detector. When the OUT pin rises above the detected voltage (4.4V), POK2 will transition from low to high state. Similarly, when the output falls below 4.4V, POK2 will transition from high to low. A 10kΩ pull-up resistor is recommended.
3	SESDET	Session detect. Open drain output with 2.0V voltage detector. When the OUT pin rises above the detected voltage (2.0V), it will transition from low to high state. Similarly, when the output falls below 2.0V, SESDET will transition from high to low. A 10kΩ pull-up resistor is recommended.
4	SRRDY	Session request ready. Open drain output with 0.6V voltage detector. When the OUT pin rises above the detected voltage (0.6V), it will transition from low to high state. Similarly, when the output falls below 0.6V, SRRDY will transition from high to low. A 10kΩ pull-up resistor is recommended.
5	OUT	Power output to VBUS.
6	C1+	Flying capacitor 1 positive terminal.
7	C1-	Flying capacitor 1 negative terminal.
8, 13	N/C	No connect.
9	OUTCP	Charge pump output. Requires 1μF bypass capacitor to ground.
10	C2+	Flying capacitor 2 positive terminal.
11	C2-	Flying capacitor 2 negative terminal.
12	GND	Ground.
14	VIN	Input power supply. Requires 1μF bypass capacitor to ground.
15	SR	Session request input control pin. Should not be left floating. Must connect to high or low. For more details, see Table 1.
16	EN	Enable input control pin. When in the low state, the AAT3125 is powered down and consumes a small amount of power. When connected high, it is in normal operation. This pin should not be left floating. For more details, see Table 1.
EP		Exposed paddle (bottom); connect to GND directly beneath package.

### Pin Configuration

**QFN44-16  
(Top View)**

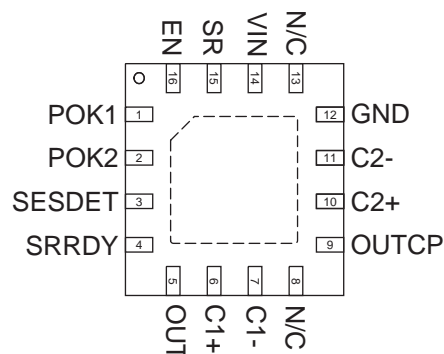

### Absolute Maximum Ratings<sup>1</sup>

Symbol	Description	Value	Units
$V_{IN}, V_{OUT}$	Any Pin to GND	-0.3 to 6	V
$t_{SC}$	OUT Short-Circuit Duration	Indefinite	s
$I_{OUT}^2$	Output Current	150	mA
$T_J$	Operating Temperature Range	-40 to 85	°C
$T_S$	Storage Temperature Range	-65 to 150	°C
$V_{ESD}$	ESD Rating <sup>3</sup> - HBM	2000	V

### Thermal Information

Symbol	Description	Value	Units
$\theta_{JA}$	Maximum Thermal Resistance <sup>4</sup>	50	°C/W
$P_D$	Maximum Power Dissipation ( $T_A = 25^\circ\text{C}$ ) <sup>5</sup>	2.0	W

- 
1. Stresses above those listed in Absolute Maximum Ratings may cause permanent damage to the device. Functional operation at conditions other than the operating conditions specified is not implied. Only one Absolute Maximum Rating should be applied at any one time.
  2. Based on long-term current density limitation.
  3. Human body model is a 100pF capacitor discharged through a 1.5kΩ resistor into each pin.
  4. Mounted on an FR4 board.
  5. Derate 20mW/°C above 25°C.

### Electrical Characteristics<sup>1</sup>

$V_{IN} = 3.5V$ ;  $C_{IN} = C_{OUT} = C_1 = C_2 = 1.0\mu F$ ;  $T_A = -40^\circ C$  to  $+85^\circ C$ .  
 Unless otherwise noted, typical values are  $T_A = 25^\circ C$ .

Symbol	Description	Conditions	Min	Typ	Max	Units
<b>Input Power Supply</b>						
$V_{IN}$ Operating Range			2.9		5.5	V
$I_{cc3}$	Operating Current SRP	EN = 1, SR = 1, OUT = IN		60	110	$\mu A$
$I_{cc2}$	Operating Current CP	EN = 1, SR = 0		1	3	mA
$I_{cc1}$	Shutdown Current 1	EN = 0, SR = 1		1	2	$\mu A$
$I_{cc0}$	Shutdown Current 0	EN = 0, SR = 0			1	$\mu A$
<b>Output Power Supply</b>						
$V_{OUT}$	Output Regulation	$I_{OUT} = 0$	4.6		5.25	V
$I_{CCOUT}$	Operating Current	EN = 0		7	12	$\mu A$
$I_{OUT}$	Output Current	$3.2 \leq V_{IN} \leq 5.5V, V_{OUT} > 4.4V$	50	65		mA
		$3.35 \leq V_{IN} \leq 5.5V, V_{OUT} > 4.4V$		100		
$V_{CS}$	Current Sense Trip Level	$VCS = I_{OUT} \times R_{CS}$	40	60	90	mV
$R_{OFF}$	Pull-Down Resistance	EN = 0, SR = 1	700	1000	1500	$\Omega$
$I_{SR}$	SR Current Pulse	OUT < (IN-1.0v)	5	10	20	mA
<b>Charge Pump</b>						
$\eta$	Efficiency	$V_{IN} = 3.75V, I_{OUT} = 50mA$		90		%
$T_{SS}$	Soft-Start Time	OUT < 0.1 to OUT > 4.4		100		$\mu s$
$F_{CLK}$	Clock Frequency			750		kHz
<b>EN, SR</b>						
$V_{IL}$	Input Threshold Low				0.4	V
$V_{IH}$	Input Threshold High		1.4			V
$I_{EN(SINK)}$	EN Input Current	$V_{IN} = V_{EN} = 5.5V$	-1		1	$\mu A$
$I_{SR(SINK)}$	SR Input Current	$V_{IN} = V_{SR} = 5.5V$	-1		1	$\mu A$
<b>POK1</b>						
$V_{POK1}$	POK Trip Threshold	$V_{OUT}$ Rising	3.8	4.0	4.2	V
$V_{POK1(HYS)}$	POK Hysteresis			50		mV
$V_{POK1(OL)}$	POK Output Voltage	$I_{SINK} = 1mA$			0.3	V
$I_{POK1}$	POK Leakage Current	$V_{POK} = 5.5, 25^\circ C$			100	nA
<b>POK2</b>						
$V_{POK2}$	POK Trip Threshold	$V_{OUT}$ Rising	4.18	4.4	4.62	V
$V_{POK2(HYS)}$	POK Hysteresis			50		mV
$V_{POK2(OL)}$	POK Output Voltage	$I_{SINK} = 1mA$			0.3	V
$I_{POK2}$	POK Leakage Current	$V_{POK} = 5.5, 25^\circ C$			100	nA

1. The AAT3125 is guaranteed to meet performance specifications over the  $-40^\circ C$  to  $+85^\circ C$  operating temperature range and is assured by design, characterization, and correlation with statistical process controls.

### Electrical Characteristics<sup>1</sup>

$V_{IN} = 3.5V$ ;  $C_{IN} = C_{OUT} = C_1 = C_2 = 1.0\mu F$ ;  $T_A = -40^{\circ}C$  to  $+85^{\circ}C$ .  
 Unless otherwise noted, typical values are  $T_A = 25^{\circ}C$ .

Symbol	Description	Conditions	Min	Typ	Max	Units
<b>SESDT</b>						
$V_{SD}$	SD Trip Threshold	$V_{OUT}$ Rising	1.9	2.0	2.1	V
$V_{SD(HYS)}$	SD Hysteresis			50		mV
$V_{SD(OL)}$	SD Output Voltage	$I_{SINK} = 1mA$			0.3	V
$I_{SD}$	SD Leakage Current	$V_{SD} = 5.5, 25^{\circ}C$			100	nA
<b>SRRDY</b>						
$V_{SRRDY}$	SRRDY Trip Threshold	$V_{OUT}$ Rising	0.4	0.6	0.8	V
$V_{SRRDY(HYS)}$	SRRDY Hysteresis			20		mV
$V_{SRRDY(OL)}$	SRRDY Output Voltage	$I_{SINK} = 1mA$			0.3	V
$I_{SRRDY}$	SRRDY Leakage Current	$V_{SRRDY} = 5.5, 25^{\circ}C$			100	nA

EN	SR	Charge Pump	Current Source	SRRDY	POK	SESDT	Discharge Resistor
1	0	ON	OFF	ON	ON	ON	OFF
1	1	OFF	ON	ON	ON	ON	OFF
0	0	OFF	OFF	OFF	OFF	ON	OFF
0	1	OFF	OFF	OFF	OFF	ON	ON

**Table 1: Operational States.**

1. The AAT3125 is guaranteed to meet performance specifications over the  $-40^{\circ}C$  to  $+85^{\circ}C$  operating temperature range and is assured by design, characterization, and correlation with statistical process controls.

### Typical Characteristics

Unless otherwise noted,  $V_{IN} = 3.5V$ ,  $C_{IN} = C_{OUT} = C_1 = C_2 = 1\mu F$ ,  $T_A = 25^\circ C$ .

Charge Pump ON/OFF Timing

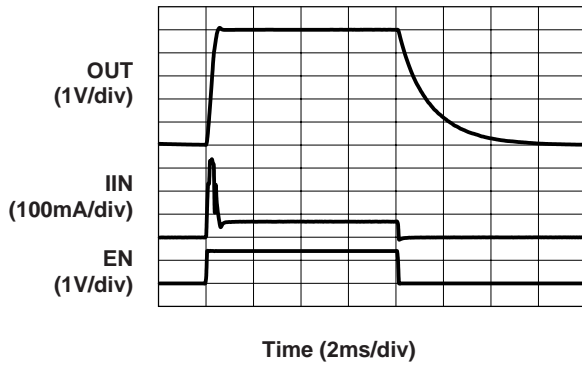

Efficiency vs. Load Current

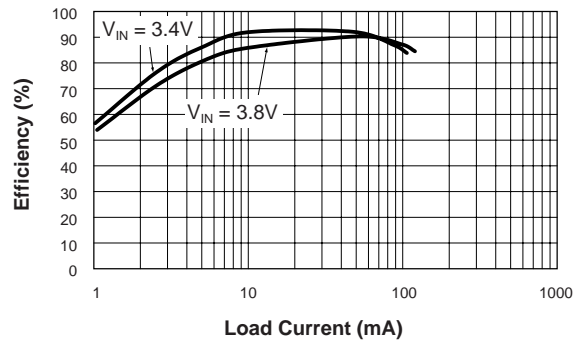

Charge Pump Waveforms  
(100mA load)

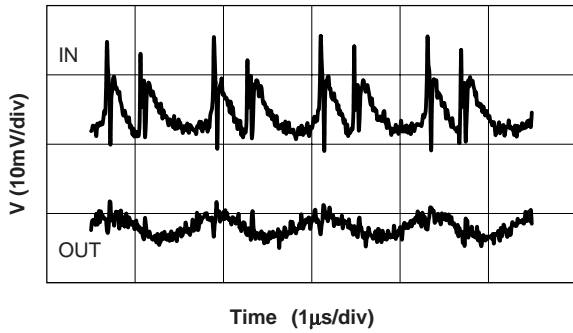

Load Transient Response  
(10mA to 100mA)

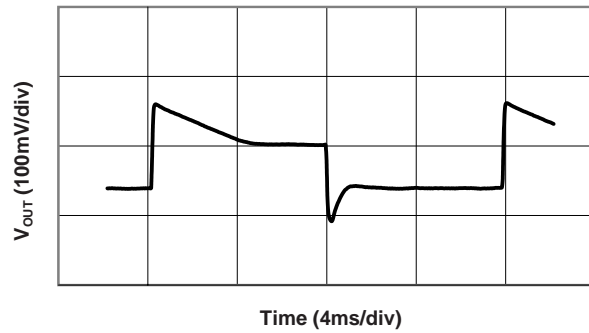

Charge Pump Output Voltage  
vs. Load Current

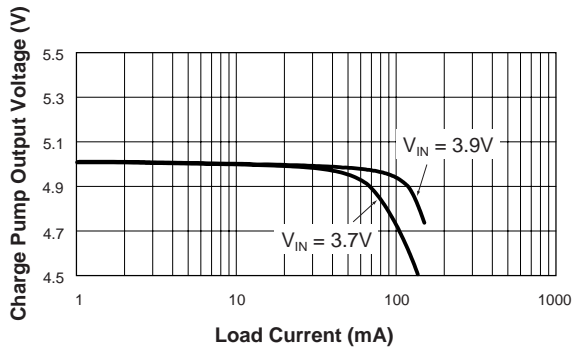

Charge Pump Output Voltage vs. Input Voltage  
( $I_{LOAD} = 100mA$ )

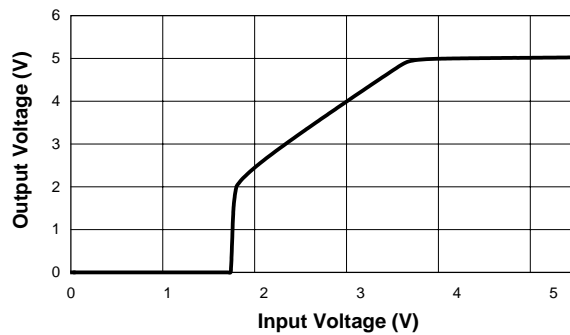

### Typical Characteristics

Unless otherwise noted,  $V_{IN} = 3.5V$ ,  $C_{IN} = C_{OUT} = C_1 = C_2 = 1\mu F$ ,  $T_A = 25^\circ C$ .

**Operating Current vs. Input Voltage**  
(EN = 1; SR = 0; Charge Pump Mode)

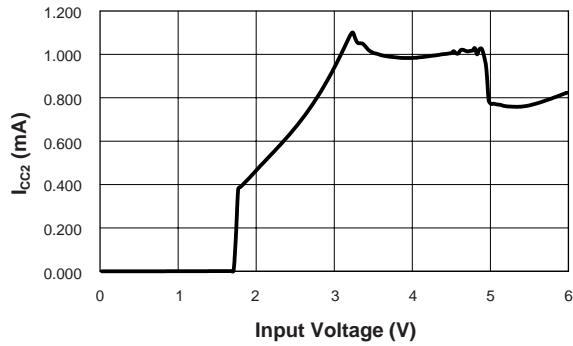

**Operating Current vs. Input Voltage**  
(EN = 1; SR = 0; Outside Current Source Mode)

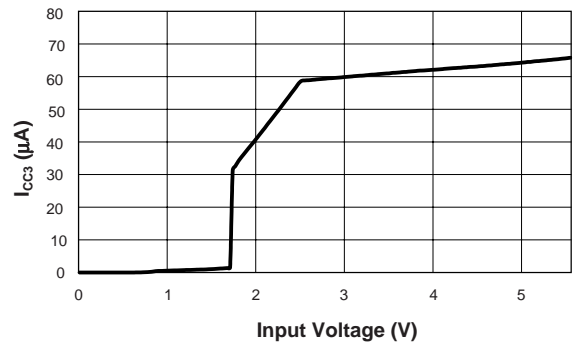

**Shutdown Current vs. Input Voltage**  
(EN = 0; SR = 1)

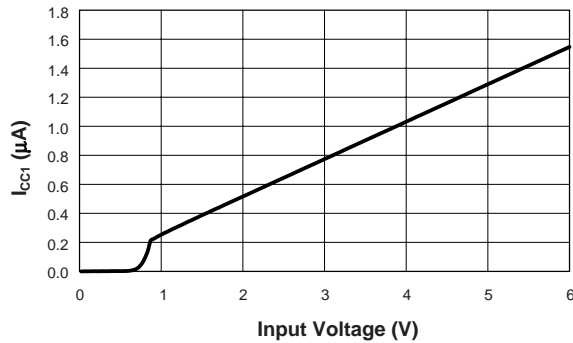

**I\_ccOUT vs. V\_OUT**

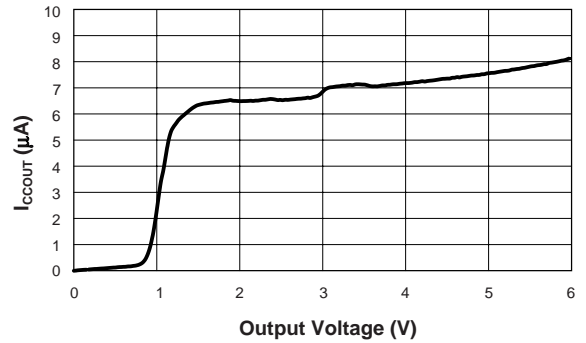

**I\_SR vs. V\_OUT**  
(EN = 1; SR = 1)

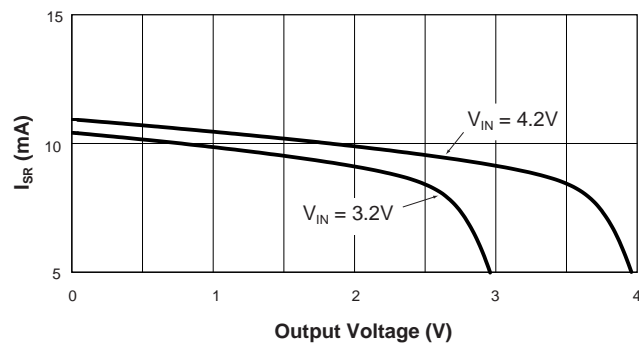

**Charge Pump POK Timing**

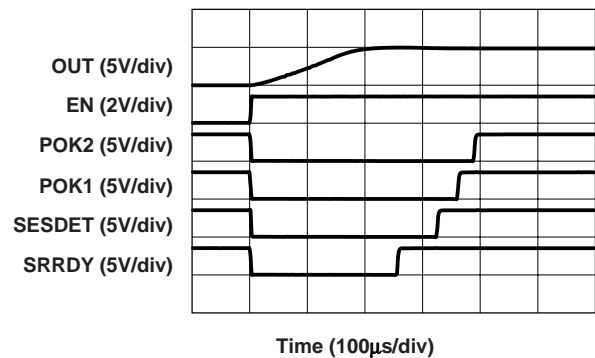

### Typical Characteristics

Unless otherwise noted,  $V_{IN} = 3.5V$ ,  $C_{IN} = C_{OUT} = C_1 = C_2 = 1\mu F$ ,  $T_A = 25^\circ C$ .

**Falling SESEDET Timing**

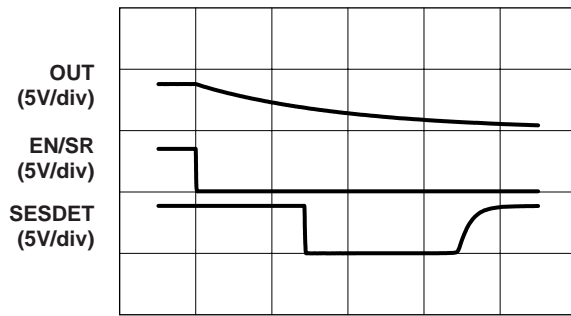

Time (100ms/div)

**Rising SESEDET, SRRDY Timing  
(120 $\mu F$  Load)**

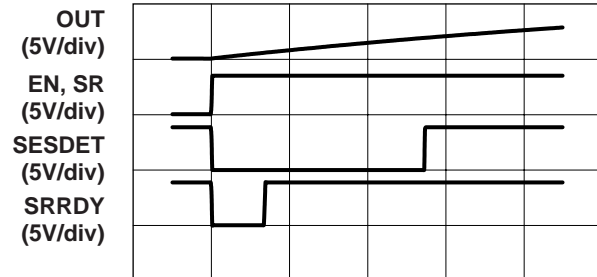

Time (10ms/div)

**$V_{BUS}$  Pulsing for SRP  
( $V_{BUS}$  Rise Time; 5 $\mu F$  on  $V_{BUS}$ )**

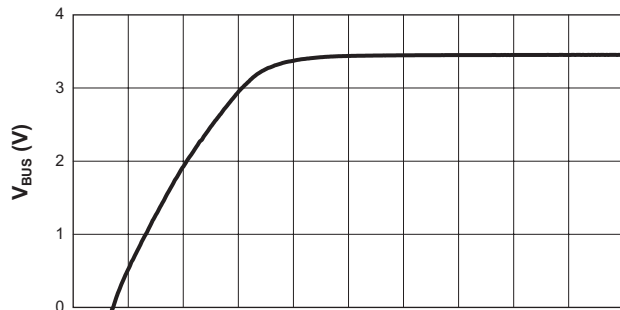

Time (1ms/div)

**$V_{BUS}$  Pulsing for SRP  
( $V_{BUS}$  Rise Time; 100 $\mu F$  on  $V_{BUS}$ )**

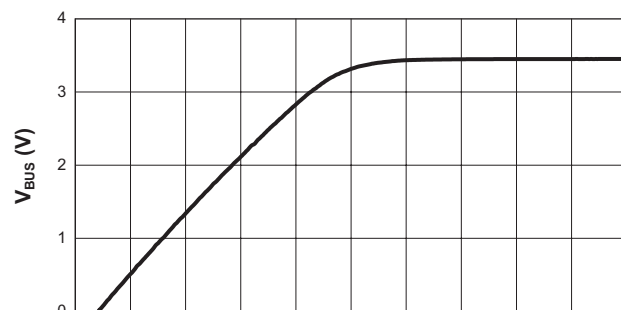

Time (10ms/div)





(open) when OUT is above the SRRDY threshold or when EN is a logic low. Upon activation by EN, there is no negative glitch that can be mistaken for OUT below 0.8V.

### **Power OK**

USB OTG devices connected as Host must maintain  $V_{OUT}$  above 4.4 volts or report that it is below 4.4 volts. Two Power OK outputs (POK1 and POK2) provide a window comparison of the  $V_{OUT}$  voltage. The POK1 open drain output is pulled low if  $V_{OUT}$  drops below  $4.0V \pm 5\%$ , and the POK2 open drain output is pulled low if  $V_{OUT}$  drops below  $4.4V \pm 5\%$ .

### **Under-Voltage Lockout**

Circuits other than the MicroPower voltage detector (SESDet) require voltage to be present on IN. Under-voltage lockout guarantees that sufficient voltage is present on IN to ensure operation. All functions other than the SESDET flag are disabled if the voltage on IN is less than 2V.

### **Discharge Resistor**

In accordance with the USB OTG specification, a pull-down resistor is provided to discharge  $V_{BUS}$  at a current of not more than 8mA.

### **Over-Temperature Protection**

If the AAT3125 junction temperature exceeds  $125^{\circ}\text{C}$ , the charge pump is shut down.

### Ordering Information

Package	Marking <sup>1</sup>	Part Number (Tape and Reel) <sup>2</sup>
QFN44-16	ITXYY	<b>AAT3125ISN-T1</b>



All AnalogicTech products are offered in Pb-free packaging. The term “Pb-free” means semiconductor products that are in compliance with current RoHS standards, including the requirement that lead not exceed 0.1% by weight in homogeneous materials. For more information, please visit our website at <http://www.analogictech.com/pbfree>.

### Package Information

#### QFN44-16

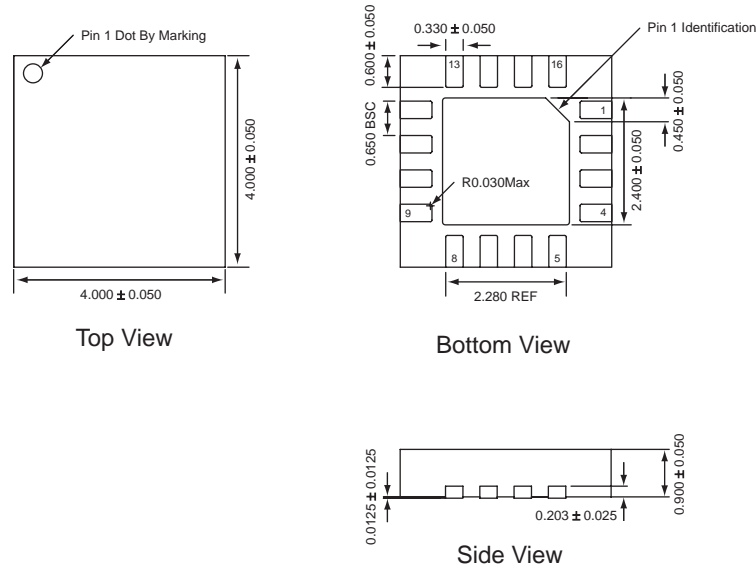

All dimensions in millimeters.

1. XYY = assembly and date code.
2. Sample stock is generally held on part numbers listed in **BOLD**.

© Advanced Analogic Technologies, Inc.

AnalogicTech cannot assume responsibility for use of any circuitry other than circuitry entirely embodied in an AnalogicTech product. No circuit patent licenses, copyrights, mask work rights, or other intellectual property rights are implied. AnalogicTech reserves the right to make changes to their products or specifications or to discontinue any product or service without notice. Customers are advised to obtain the latest version of relevant information to verify, before placing orders, that information being relied on is current and complete. All products are sold subject to the terms and conditions of sale supplied at the time of order acknowledgement, including those pertaining to warranty, patent infringement, and limitation of liability. AnalogicTech warrants performance of its semiconductor products to the specifications applicable at the time of sale in accordance with AnalogicTech's standard warranty. Testing and other quality control techniques are utilized to the extent AnalogicTech deems necessary to support this warranty. Specific testing of all parameters of each device is not necessarily performed.

**Advanced Analogic Technologies, Inc.**  
**830 E. Arques Avenue, Sunnyvale, CA 94085**  
**Phone (408) 737-4600**  
**Fax (408) 737-4611**

