

PWM TYPE 3-PHASE DC BRUSHLESS MOTOR CONTROL IC

◆ GENERAL DESCRIPTION

The **NJM2625A** is a 3-phase DC brush-less motor control IC with PWM control.

It incorporates hall amplifiers, PWM control circuits, totem-pole pre drivers for external power MOS transistors, current limit and frequency generator circuit.

The NJM2625A easily implements speed control and rotation direction control for DC motor application.

◆ PACKAGE OUTLINE

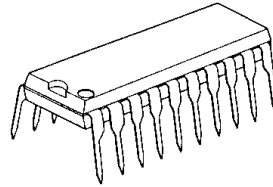

NJM2625AD

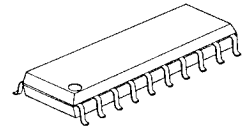

NJM2625AM

◆ FEATURES

- Operating Voltage (V⁺=8V to 18V)
- Pre-Driver Circuit (I_{out}=+50mA/-150mA MAX.)
- Current Limit Sense Voltage (Current limit=0.5V±10%)
- Internal Oscillator (Frequency control for external capacitor)
- Forward or Reverse Direction
- FG Signal Output (Output frequency to hall frequency)
- Internal Soft Start (External capacitor to Verr pin.)
- Internal ON/OFF Circuit (No-output is Verr pin to GND.)
- Bipolar Technology
- Package Outline DIP20, DMP20

◆ PIN CONFIGURATION

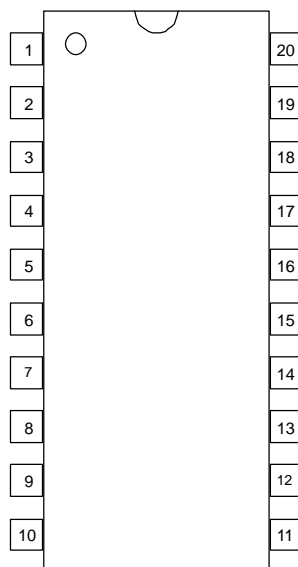

NJM2625AD
NJM2625AM

PIN FUNCTION

1.FG	11.GND
2.Vref	12.I _{LIMIT}
3.H1+	13.WL
4.H1-	14.VL
5.H2+	15.UL
6.H2-	16.WH
7.H3+	17.VH
8.H3-	18.UH
9.Verr	19.V ⁺
10.OSC	20.F/R

NJM2625A

◆ BLOCK DIAGRAM

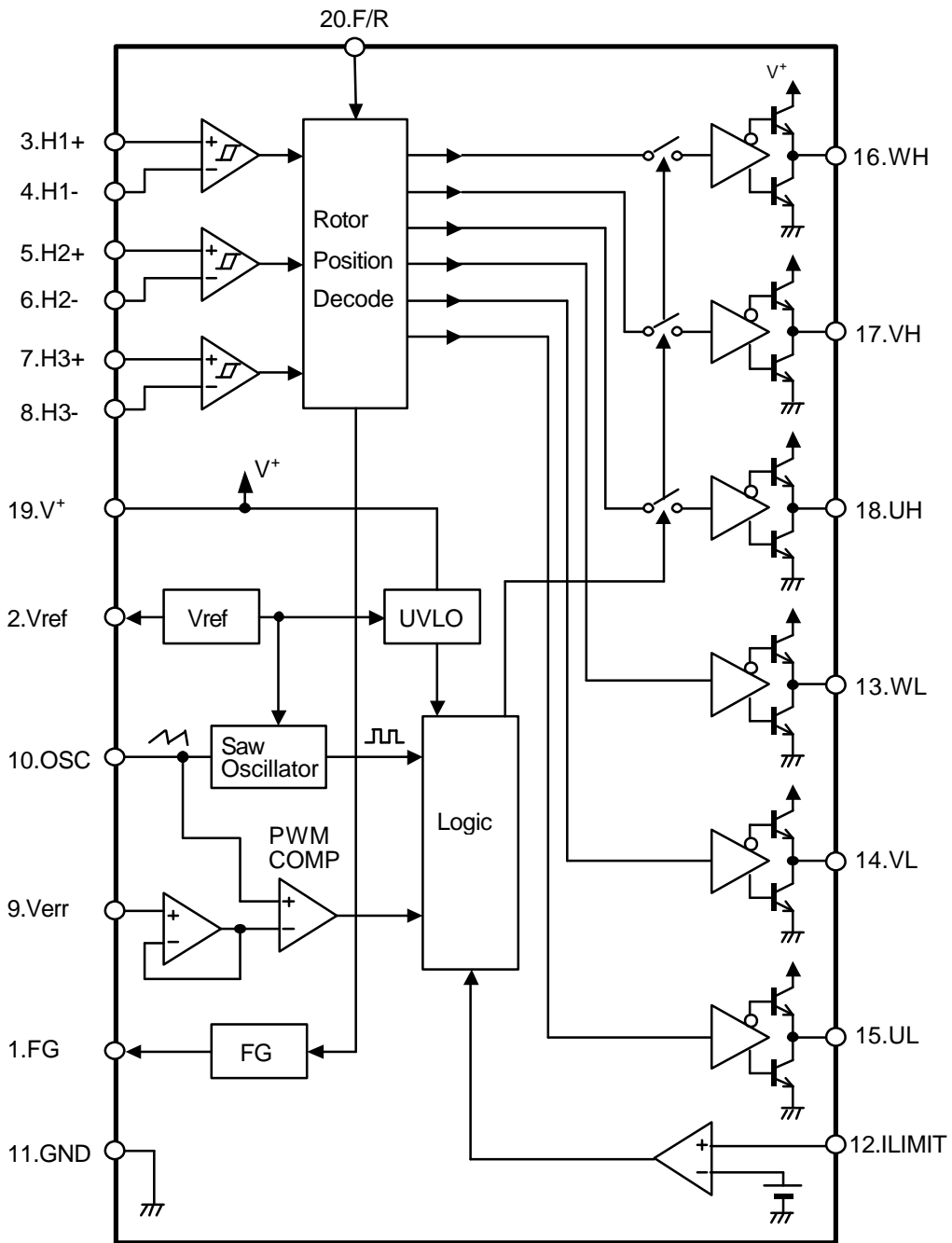

◆ ABSOLUTE MAXIMUM RATINGS (Ta=25°C)

PARAMETER	SYMBOL	RATINGS	UNIT
Maximum Supply Voltage	V ⁺	20	V
Power Dissipation	P _D	(DIP20) 700 (DMP20) 350	mW
Operating Temperature Range	T _{opr}	-40 ~ +85	°C
Storage Temperature Range	T _{stg}	-50 ~ +150	°C

◆ ELECTRICAL CHARACTERISTICS (V⁺=12V, C_t=1000pF, C_{ref}=1μF, Ta=25°C)

Total Device

PARAMETER	SYMBOL	TEST CONDITIONS	MIN.	TYP.	MAX.	UNIT
Supply Voltage	V ⁺		8.0	-	18.0	V
Under Voltage Sense Voltage (Under Voltage Lock Out)	UVLO	Output Enable V ⁺ Decreasing	7.00	7.25	7.50	V
Hysteresis Voltage (Under Voltage Lock Out)	ΔUVLO		0.4	0.5	0.6	V
Supply Current	I _{cc}	R _L =∞ PWM Duty=50%	-	15.0	22.0	mA

Hall Sensor Section

PARAMETER	SYMBOL	TEST CONDITIONS	MIN.	TYP.	MAX.	UNIT
Hysteresis Voltage	V _{hys}	R _L =470Ω	-	30	-	mV
Input Common mode Voltage range	V _{icm}	R _L =470Ω	1.5	-	10.5	V
Input Bias Current	I _B		-	-	600	nA

Output Section

PARAMETER	SYMBOL	TEST CONDITIONS	MIN.	TYP.	MAX.	UNIT
Output Voltage 1	V _{oh}	I _{source} =50mA	10	10.3	-	V
Output Voltage 2	V _{ol}	I _{sink} =150mA	-	1.5	2.0	V

Over Current Sense Section

PARAMETER	SYMBOL	TEST CONDITIONS	MIN.	TYP.	MAX.	UNIT
Sense Voltage	V _{th}		0.45	0.50	0.55	V
Input Voltage Range	V _{ip}		-	-	3.0	V
Input Bias Current	I _{IB}		-	-0.9	-5.0	μA

Oscillator Section

PARAMETER	SYMBOL	TEST CONDITIONS	MIN.	TYP.	MAX.	UNIT
Oscillation Frequency	f _{osc}		20	25	30	kHz
Oscillate Fluctuations (Line Regulation)	f _{osc} / V	V ⁺ =8V to 18V	-	0.01	5.00	%
PWM0% Sense Voltage	PWM0	PWM DUTY=0%	-	-	0.35	V
PWM100% Sense Voltage	PWM1	PWM DUTY=100%	5.40	-	-	V
Saw Wave Peak Voltage	V _{pfosc}		4.75	5.00	5.25	V
Saw Wave Bottom Voltage	V _{bfosc}		0.50	0.65	0.80	V

NJM2625A

◆ ELECTRICAL CHARACTERISTICS ($V^+=12V$, $C_t=1000pF$, $C_{ref}=1\mu F$, $T_a=25^\circ C$)

FG Output Section

PARAMETER	SYMBOL	TEST CONDITIONS	MIN.	TYP.	MAX.	UNIT
Saturation Voltage	FGV		-	0.3	0.5	V
Pull-Up Resistance	FGR		8	10	12	k Ω

Error Amplifier Section

PARAMETER	SYMBOL	TEST CONDITIONS	MIN.	TYP.	MAX.	UNIT
Input Offset Voltage	V_{io}		-	7	-	mV
Input Offset Current	I_{io}		-	8.0	-	nA
Input Bias Current	I_{ibr}		-	-46	-	nA
Input Common mode Voltage range	V_{icmrr}		0	-	V_{ref}	V

Reference Voltage Section

PARAMETER	SYMBOL	TEST CONDITIONS	MIN.	TYP.	MAX.	UNIT
Output Voltage	V_{ref}	$I_{ref}=1.0mA$	6.00	6.40	6.80	V
Line Regulation	V_{refLI}	$V^+=8V$ to 18V	-	1.5	25	mV
Road Regulation	V_{refLO}	$I_{ref}=1.0mA$ to 20.0mA	-	150	250	mV

Forward or Reverse Direction Section

PARAMETER	SYMBOL	TEST CONDITIONS	MIN.	TYP.	MAX.	UNIT
Forward Direction	VF	$R_L=470\Omega$	V^+-2	-	V^+	V
Reverse Direction	VR	$R_L=470\Omega$	-	-	2	V
Hysteresis Voltage	VFR	$R_L=470\Omega$	-	0.5	-	V

(note) Output switch tests are performed under pulsed conditions to minimize power dissipation.

◆ FG Output

	Input			FG Output
	H1	H2	H3	
1	H	L	H	H
2	H	L	L	L
3	H	H	L	H
4	L	H	L	L
5	L	H	H	H
6	L	L	H	L

◆ F/R Input Pin

This pin dose not include neither pull up resistance nor pull down resistance.

Terminal Voltage	Direction
L input	F
H input	R

◆ TYPICAL APPLICATION

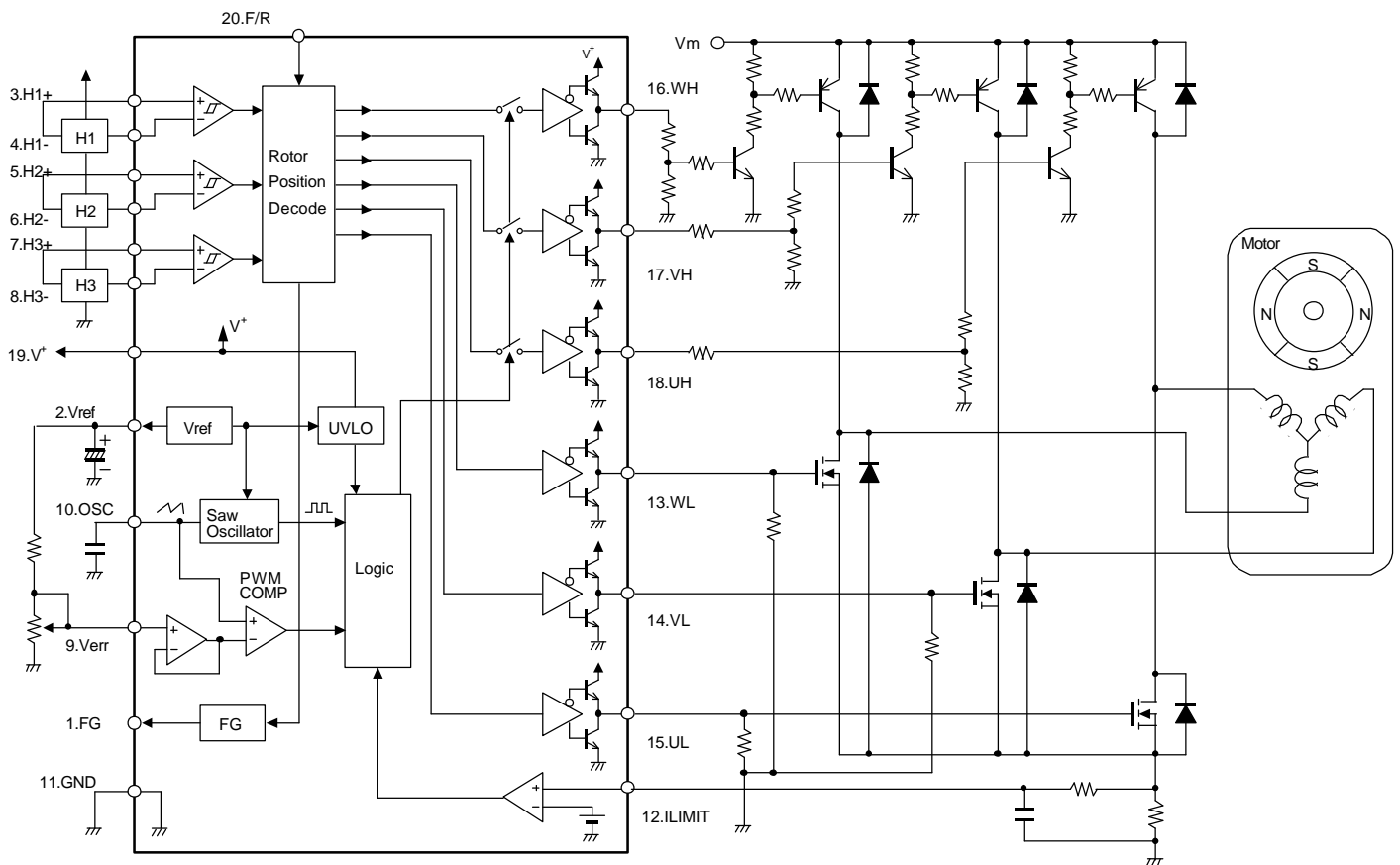

- A rotation direction change must be made after motor stopped completely.
- When PWM duty is extremely small, two or more switching elements cannot be driven entirely. In such case, switching elements will generate excess heat and it may cause destruction of the switching devices. Therefore, extensive heat evaluation is necessary for switching device selection particularly in consideration of the area of safety operation (ASO).

NJM2625A

◆ TYPICAL CHARACTERISTICS

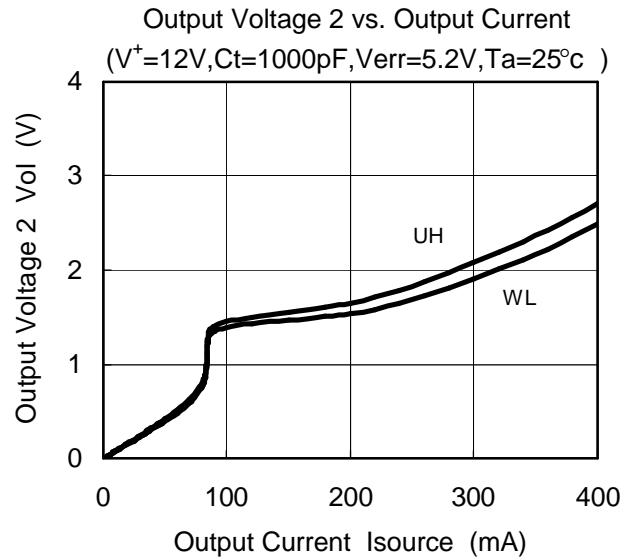
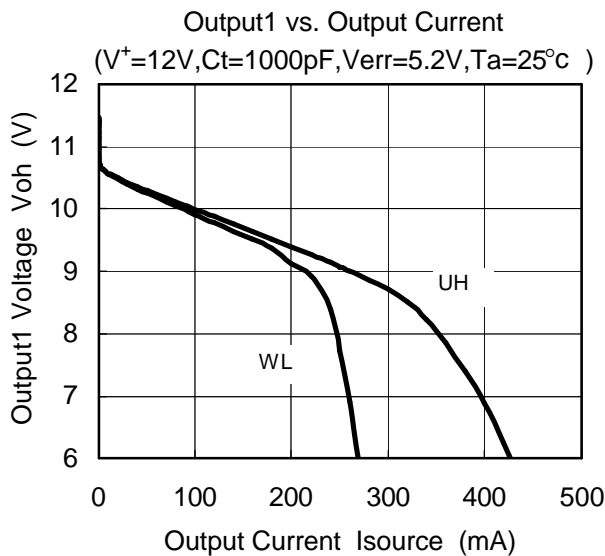
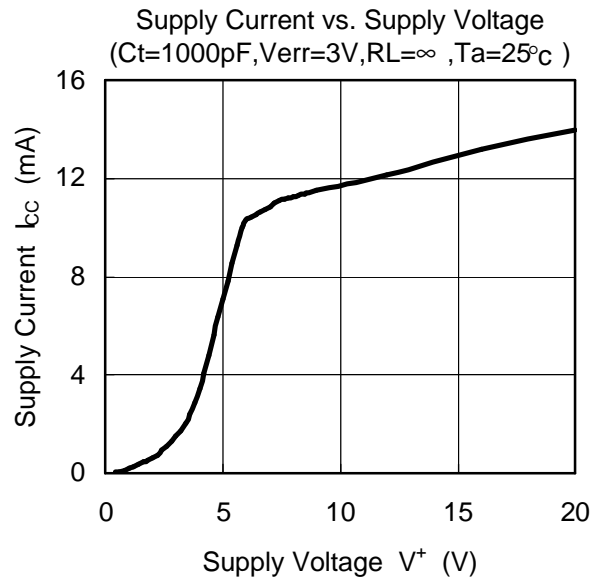
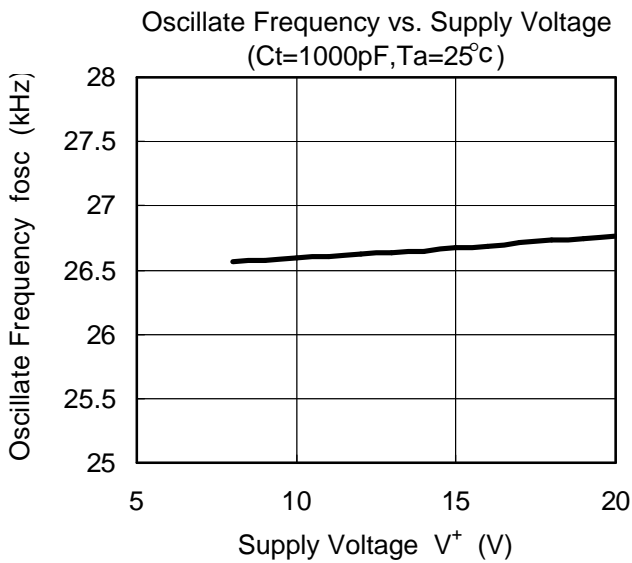
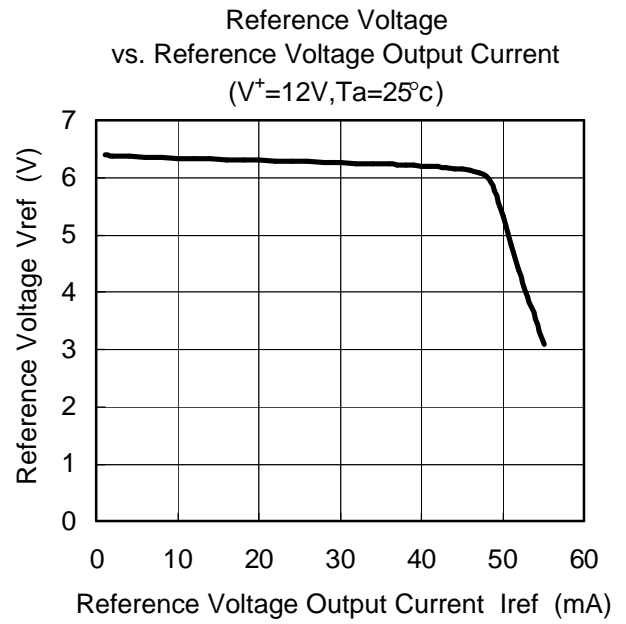
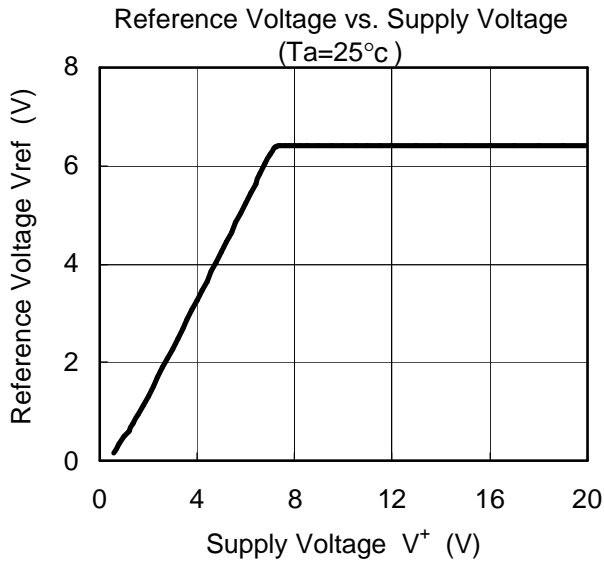

■ TYPICAL CHARACTERISTICS

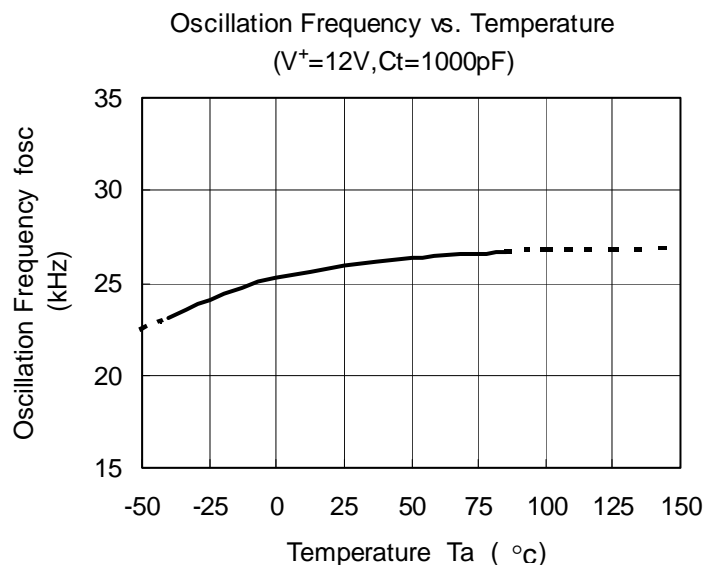
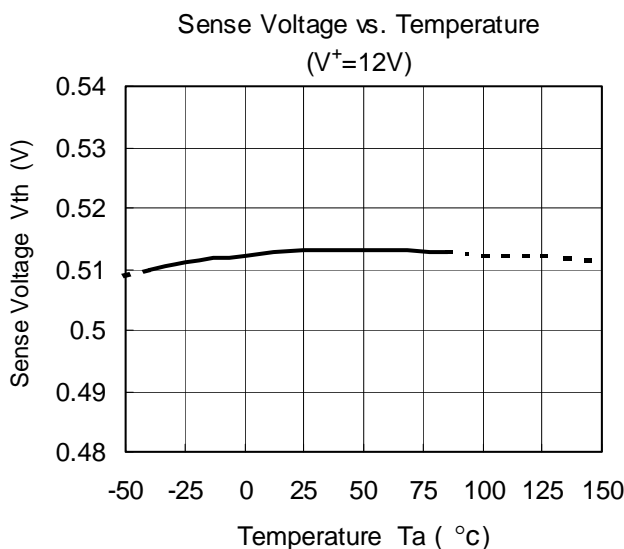
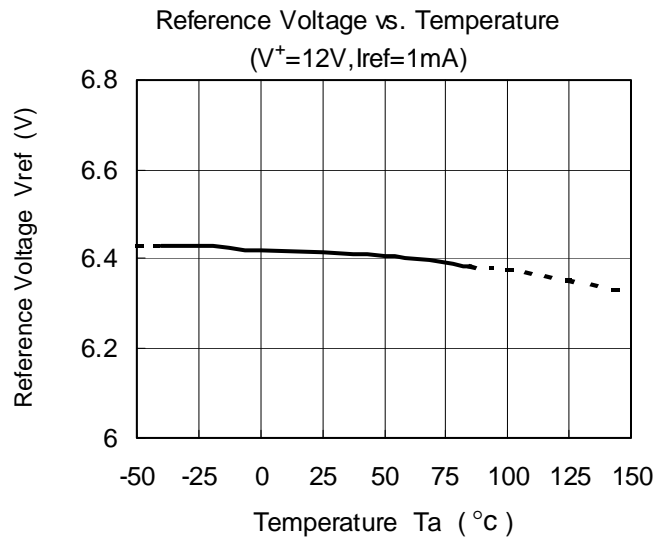
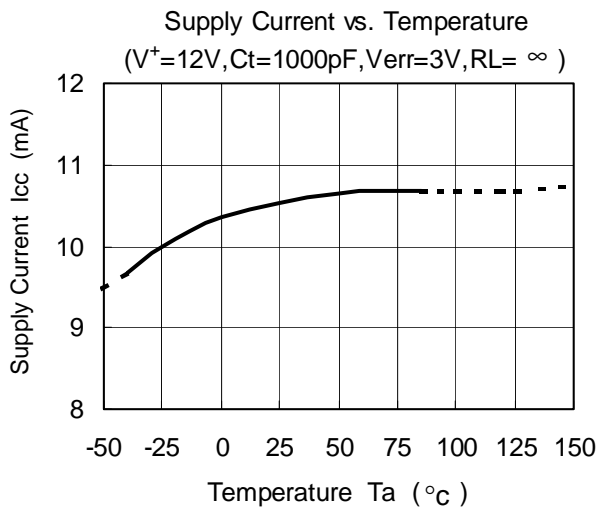
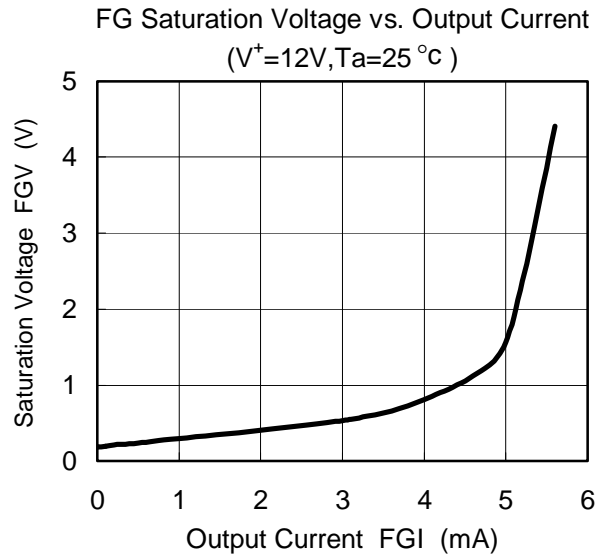
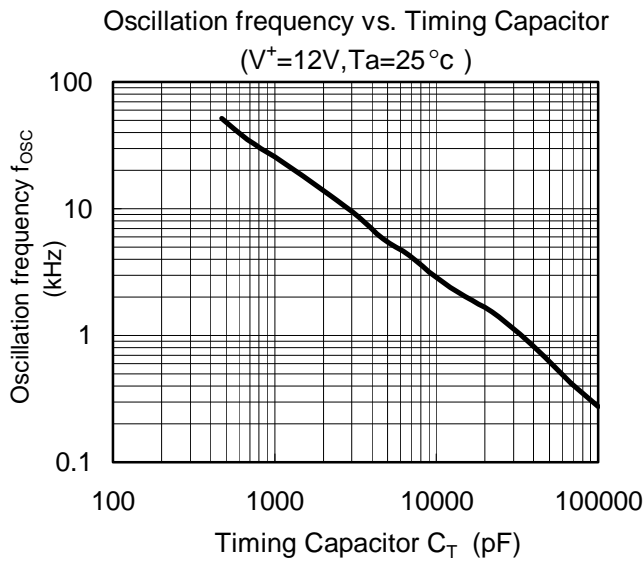

NJM2625A

MEMO

The specifications on this data book are only given for information, without any guarantee as regards either mistakes or omissions. The application circuit in this data book are described only to show representative usages of the product and not intended for the guarantee or permission of any right including the industrial rights.