MULTI-FUNCTION MODULE FILTERS



Primary Power Components Division

[EMI Filter Cross Reference](#)

[EMI Filter Inquiry Form](#)

**RoHS
Compliant**

880-03/002		A	3	2.46 x 1.97 x 2.34	Yes	Double	D P*	No
880-03/005		B	3	2.46 x 1.97 x 2.34	Yes	Single	D P*	No
880-06/003		A	6	2.46 x 1.97 x 2.34	Yes	Double	D P*	No
880-06/006		B	6	2.46 x 1.97 x 2.34	Yes	Single	D P*	No

882 Series Multi-Function Module Filters

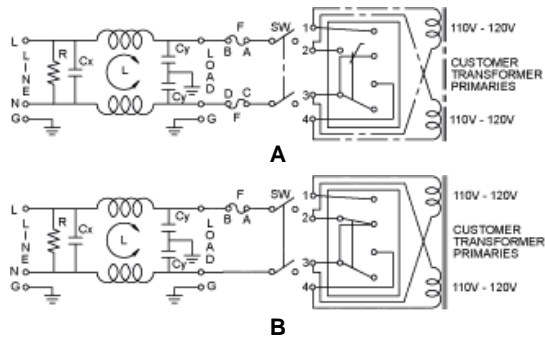

Part Number		Electrical Schematic	Amp Rating	Size L x W x H	IEC Conn	Fuse Holder	Power Switch	Voltage Selector
882-03/001		A	3	2.17 x 1.12 x 2.13	Y	DUAL	DP	Y
882-03/003		B	3	2.17 x 1.12 x 2.13	Y	SINGLE	DP	Y
882-06/011		A	6	2.17 x 1.12 x 2.13	Y	DUAL	DP	Y
882-06/013		B	6	2.17 x 1.12 x 2.13	Y	SINGLE	DP	Y
882-10/016		A	10	2.17 x 1.12 x 2.13	Y	DUAL	DP	Y
882-10/018		B	10	2.17 x 1.12 x 2.13	Y	SINGLE	DP	Y

THESE DRAWINGS ARE THE PROPERTY OF QUALTEK ELECTRONICS AND NOT TO BE REPRODUCED FOR OR COMMUNICATED TO A THIRD PARTY WITHOUT THE EXPRESS WRITTEN PERMISSION OF AN OFFICER OF QUALTEK ELECTRONICS.

1. PHYSICAL DIMENSIONS

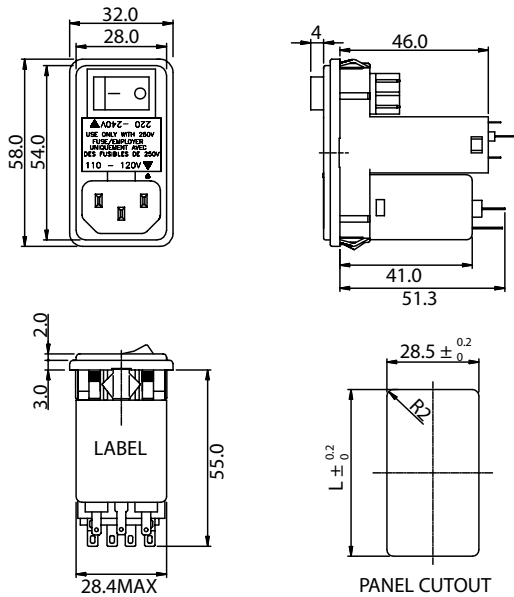

PANEL CUTOUT
(MOUNTING FROM FRONT)
L ACCORDING TO PANEL THICKNESS
0.8~2.0mm L=55.9
2.1~3.2mm L=56.2

2. ELECTRICAL SCHEMATIC

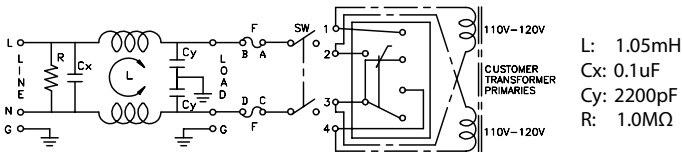

REVISION		
REV.	DESCRIPTION	APPROVED
B	RoHS Compliancy	DP

ELECTRICAL CHARACTERISTICS:

- 1-1. VOLTAGE RATING.....115/250VAC
- 1-2. CURRENT RATING
A. @ 115 VAC.....6 A RMS MAX
B. @ 250 VAC.....6 A RMS MAX
- 1-3. OPERATING FREQUENCY.....50/60Hz
- 1-4. LEAKAGE CURRENT: EACH LINE TO GROUND
A. @ 115 VAC 60Hz.....0.20 mA MAX
B. @ 250 VAC 50Hz.....0.40 mA MAX
- 1-5. HIPOT RATING (FOR ONE MINUTE)
A. LINE TO GROUND.....2250 VDC
B. LINE TO LINE.....1450 VDC
- 1-6. MINIMUM INSERTION LOSS IN dB: (AT 50 OHM SYSTEM)

FREQ. MHz	.01	.05	.10	.15	.50	1.0	5.0	10	30
COM. MODE dB	/	/	/	12	18	24	35	40	40
DIF. MODE dB	/	/	/	4	10	15	35	40	40

- 1-7. OPERATING TEMPERATURE.....-25° TO +85° C
- 1-8. SAFETY:
- 1-9. RoHS COMPLIANT

CONTROLLED

Dim range (mm)	Tolerance +/- (mm)	Qualtek Electronics Corp. PPC DIVISION	
		Part Number: 882-06/011	
0-1	0.15	Description: EMI FILTER	
1-6	0.20	UNIT: mm	
6-18	0.30	Drawn / Date	
18-50	0.50	B.ZHANG	
50-120	0.70		
120-250	0.90		
250-500	1.20		