

## Small Signal Zener Diodes

### Features

- Silicon Planar Power Zener Diodes.
- Standard Zener voltage tolerance is  $\pm 5\%$  with a "B" suffix (e.g.: MMBZ5225B-V), suffix "C" is  $\pm 2\%$  tolerance.
- High temperature soldering guaranteed: 260 °C/4X10 seconds at terminals.
- These diodes are also available in MiniMELF case with the type designation ZMM5225...ZMM5267, SOD-123 case with the type designation MMSZ5225-V... MMSZ5267-V.
- Lead (Pb)-free component
- Component in accordance to RoHS 2002/95/EC and WEEE 2002/96/EC

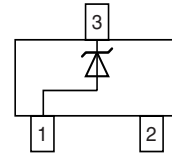
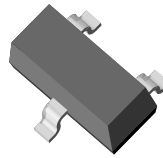

18078

### Mechanical Data

**Case:** SOT-23 Plastic case

**Weight:** approx. 8.8 mg

**Packaging Codes/Options:**

GS18 / 10 k per 13 " reel (8 mm tape), 10 k/box

GS08 / 3 k per 7 " reel (8 mm tape), 15 k/box

### Absolute Maximum Ratings

$T_{amb} = 25\text{ }^{\circ}\text{C}$ , unless otherwise specified

Parameter	Test condition	Symbol	Value	Unit
Zener current (see Table "Characteristics")				
Power dissipation	$T_A = 25\text{ }^{\circ}\text{C}$	$P_{tot}$	225 <sup>1)</sup>	mW
		$P_{tot}$	300 <sup>2)</sup>	mW

1) On FR - 5 board using recommended solder pad layout

2) On alumina substrate

### Thermal Characteristics

$T_{amb} = 25\text{ }^{\circ}\text{C}$ , unless otherwise specified

Parameter	Test condition	Symbol	Value	Unit
Thermal resistance junction to ambient air		$R_{thJA}$	556 <sup>1)</sup>	$^{\circ}\text{C}/\text{W}$
Maximum junction temperature		$T_j$	150	$^{\circ}\text{C}$
Storage temperature range		$T_s$	-65 to + 175	$^{\circ}\text{C}$

1) On FR - 5 board using recommended solder pad layout

# MMBZ5225-V to MMBZ5267-V



Vishay Semiconductors

## Electrical Characteristics

$T_{amb} = 25^\circ$  unless otherwise noted  
 Maximum  $V_F = 0.9$  V at  $I_F = 10$  mA

Partnumber	Marking Code	Nominal Zener Voltage	Test Current	Maximum Dynamic Impedance <sup>1)</sup>		Typical Temp. of Coefficient	Maximum Reverse Leakage Current				
				$V_Z @ I_{ZT1}$	$I_{ZT1}$		$Z_{ZT} @ I_{ZT}$	$Z_{ZK} @ I_{ZK} = 0.25$ mA	$\alpha_{VZ}$	$I_R$	$V_R$
				V	mA		$\Omega$	$\Omega$			
MMBZ5225-V	18E	3	20	30	1600	-0.075	50	1			
MMBZ5226-V	8A	3.3	20	28	1600	-0.07	25	1			
MMBZ5227-V	8B	3.6	20	24	1700	-0.065	15	1			
MMBZ5228-V	8C	3.9	20	23	1900	-0.06	10	1			
MMBZ5229-V	8D	4.3	20	22	2000	-0.055	5	1			
MMBZ5230-V	8E	4.7	20	19	1900	$\pm 0.030$	5	2			
MMBZ5231-V	8F	5.1	20	17	1600	$\pm 0.030$	5	2			
MMBZ5232-V	8G	5.6	20	11	1600	0.038	5	3			
MMBZ5233-V	8H	6	20	7	1600	0.038	5	3.5			
MMBZ5234-V	8J	6.2	20	7	1000	0.045	5	4			
MMBZ5235-V	8K	6.8	20	5	750	0.05	3	5			
MMBZ5236-V	8L	7.5	20	6	500	0.058	3	6			
MMBZ5237-V	8M	8.2	20	8	500	0.062	3	6.5			
MMBZ5238-V	8N	8.7	20	8	600	0.065	3	6.5			
MMBZ5239-V	8P	9.1	20	10	600	0.068	3	7			
MMBZ5240-V	8Q	10	20	17	600	0.075	3	8			
MMBZ5241-V	8R	11	20	22	600	0.076	2	8.4			
MMBZ5242-V	8S	12	20	30	600	0.077	1	9.1			
MMBZ5243-V	8T	13	9.5	13	600	0.079	0.5	9.9			
MMBZ5244-V	8U	14	9	15	600	0.082	0.1	10			
MMBZ5245-V	8V	15	8.5	16	600	0.082	0.1	11			
MMBZ5246-V	8W	16	7.8	17	600	0.083	0.1	12			
MMBZ5247-V	8X	17	7.4	19	600	0.084	0.1	13			
MMBZ5248-V	8Y	18	7	21	600	0.085	0.1	14			
MMBZ5249-V	8Z	19	6.6	23	600	0.086	0.1	14			
MMBZ5250-V	81A	20	6.2	25	600	0.086	0.1	15			
MMBZ5251-V	81B	22	5.6	29	600	0.087	0.1	17			
MMBZ5252-V	81C	24	5.2	33	600	0.087	0.1	18			
MMBZ5253-V	81D	25	5	35	600	0.089	0.1	19			
MMBZ5254-V	81E	27	4.6	41	600	0.090	0.1	21			
MMBZ5255-V	81F	28	4.5	44	600	0.091	0.1	21			
MMBZ5256-V	81G	30	4.2	49	600	0.091	0.1	23			
MMBZ5257-V	81H	33	3.8	58	700	0.092	0.1	25			
MMBZ5258-V	81J	36	3.4	70	700	0.093	0.1	27			
MMBZ5259-V	81K	39	3.2	80	800	0.094	0.1	30			
MMBZ5260-V	18F	43	3	93	900	0.095	0.1	33			
MMBZ5261-V	81M	47	2.7	105	1000	0.095	0.1	36			
MMBZ5262-V	81N	51	2.5	125	1100	0.096	0.1	39			
MMBZ5263-V	81P	56	2.2	150	1300	0.096	0.1	43			
MMBZ5264-V	81Q	60	2.1	170	1400	0.097	0.1	46			
MMBZ5265-V	81R	62	2	185	1400	0.097	0.1	47			
MMBZ5266-V	81S	68	1.8	230	1600	0.097	0.1	52			
MMBZ5267-V	81T	75	1.7	270	1700	0.098	0.1	56			

<sup>1)</sup>The Zener Impedance is derived from the 1 kHz AC voltage which results when an AC current having an RMS value equal to 10 % of the Zener current ( $I_{ZT}$  or  $I_{ZK}$ ) is superimposed on  $I_{ZT}$  or  $I_{ZK}$ . Zener Impedance is measured at two points to insure a sharp knee on the breakdown curve and to eliminate unstable units.

<sup>3)</sup> Measured at thermal equilibrium.

## Typical Characteristics ( $T_{amb} = 25\text{ }^{\circ}\text{C}$ unless otherwise specified)

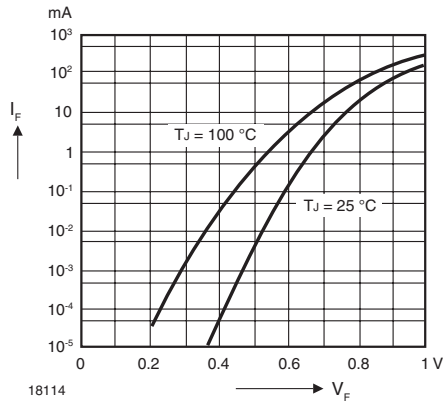

Figure 1. Forward characteristics

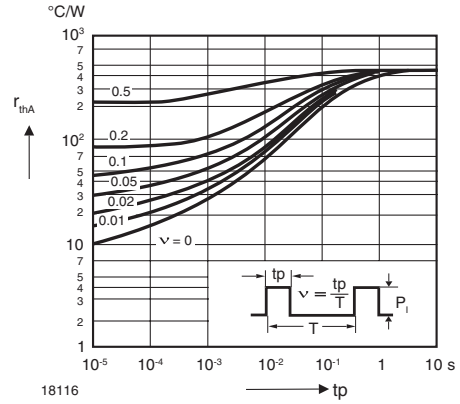

Figure 4. Pulse Thermal Resistance vs. Pulse Duration

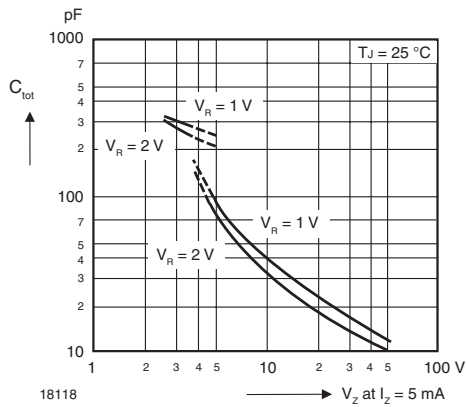

Figure 2. Capacitance vs. Zener Voltage

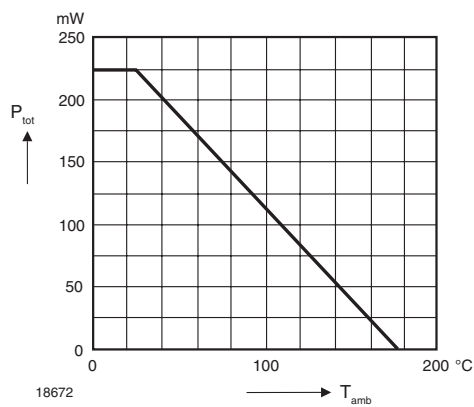

Figure 3. Admissible Power Dissipation vs. Ambient Temperature

# MMBZ5225-V to MMBZ5267-V



Vishay Semiconductors

## Package Dimensions in mm (Inches)

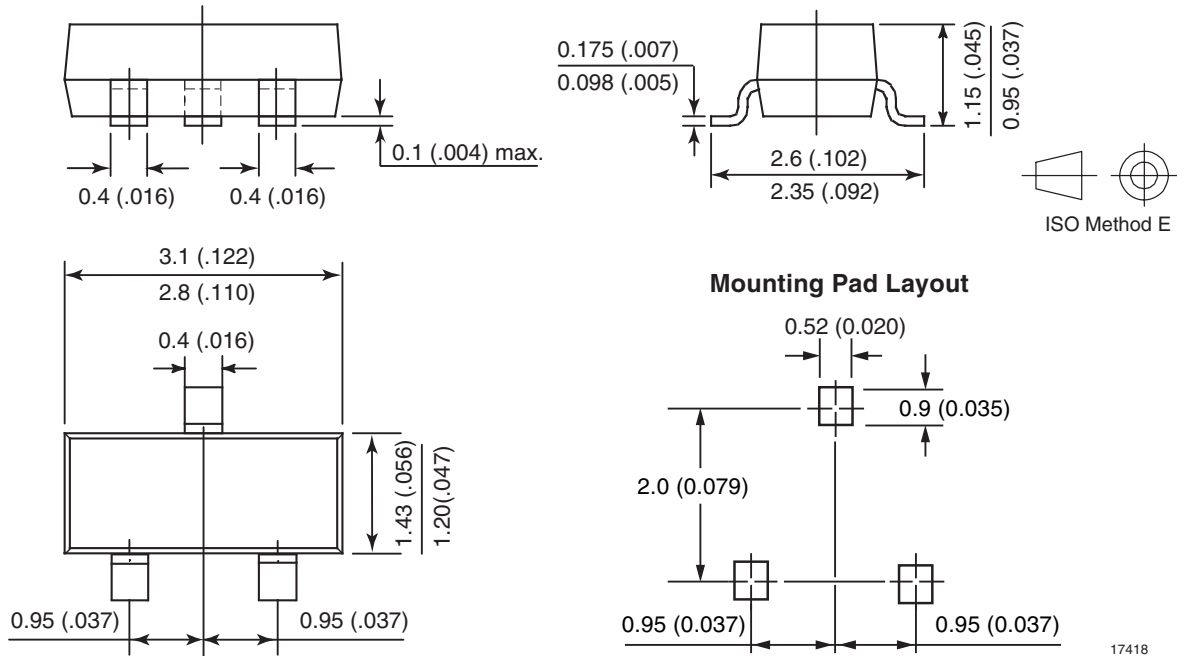



## Ozone Depleting Substances Policy Statement

It is the policy of Vishay Semiconductor GmbH to

1. Meet all present and future national and international statutory requirements.
2. Regularly and continuously improve the performance of our products, processes, distribution and operating systems with respect to their impact on the health and safety of our employees and the public, as well as their impact on the environment.

It is particular concern to control or eliminate releases of those substances into the atmosphere which are known as ozone depleting substances (ODSs).

The Montreal Protocol (1987) and its London Amendments (1990) intend to severely restrict the use of ODSs and forbid their use within the next ten years. Various national and international initiatives are pressing for an earlier ban on these substances.

Vishay Semiconductor GmbH has been able to use its policy of continuous improvements to eliminate the use of ODSs listed in the following documents.

1. Annex A, B and list of transitional substances of the Montreal Protocol and the London Amendments respectively
2. Class I and II ozone depleting substances in the Clean Air Act Amendments of 1990 by the Environmental Protection Agency (EPA) in the USA
3. Council Decision 88/540/EEC and 91/690/EEC Annex A, B and C (transitional substances) respectively.

Vishay Semiconductor GmbH can certify that our semiconductors are not manufactured with ozone depleting substances and do not contain such substances.

We reserve the right to make changes to improve technical design and may do so without further notice.

Parameters can vary in different applications. All operating parameters must be validated for each customer application by the customer. Should the buyer use Vishay Semiconductors products for any unintended or unauthorized application, the buyer shall indemnify Vishay Semiconductors against all claims, costs, damages, and expenses, arising out of, directly or indirectly, any claim of personal damage, injury or death associated with such unintended or unauthorized use.

Vishay Semiconductor GmbH, P.O.B. 3535, D-74025 Heilbronn, Germany



## Disclaimer

All product specifications and data are subject to change without notice.

Vishay Intertechnology, Inc., its affiliates, agents, and employees, and all persons acting on its or their behalf (collectively, "Vishay"), disclaim any and all liability for any errors, inaccuracies or incompleteness contained herein or in any other disclosure relating to any product.

Vishay disclaims any and all liability arising out of the use or application of any product described herein or of any information provided herein to the maximum extent permitted by law. The product specifications do not expand or otherwise modify Vishay's terms and conditions of purchase, including but not limited to the warranty expressed therein, which apply to these products.

No license, express or implied, by estoppel or otherwise, to any intellectual property rights is granted by this document or by any conduct of Vishay.

The products shown herein are not designed for use in medical, life-saving, or life-sustaining applications unless otherwise expressly indicated. Customers using or selling Vishay products not expressly indicated for use in such applications do so entirely at their own risk and agree to fully indemnify Vishay for any damages arising or resulting from such use or sale. Please contact authorized Vishay personnel to obtain written terms and conditions regarding products designed for such applications.

Product names and markings noted herein may be trademarks of their respective owners.