



Technical Characteristics

Application	Develop to help customers comply with UL Standard 508 and NEC 450
Approvals	UL Listed File Number: E61239 - CSA Certified File Number: LR37055 Guide: 184-N-90 - CE Marked
Height	4.00 Inches
Depth	3.09 Inches
Winding Material	Copper
Catalog Reference Number	9070CT9901
Width	3.00 Inches
Rating	50VA
Enclosure Type	Open
Terminal Type	Screw Clamp
Insulation Temperature	105 Degrees C
Specifications	0.41 x 1.50 Inch (Class CC) Primary Fuse Holders
Temperature Rise	55 Degrees C
Type	TF
Primary	240x480V or 230x460V or 220x440V
Phase	1-Phase
Secondary	120V or 115V or 110V
Includes	Top Mounted Fuse Block
Mounting Type	Panel

Shipping and Ordering

Category	16202 - Transformers, Industrial Control, 50 - 200 va, Type TF
Discount Schedule	CP8
Article Number	785901904779
Package Quantity	1
Weight	3.18 lbs.
Availability Code	S
Returnability	Y

As standar

Industrial Control Transformers

Type TF Transformers

120 Volt Control Secondary—Primary and Secondary Fuse Block

Voltage and Connection Options

Voltage Code	Voltages		Connections	
	Primary	Secondary	Primary	Secondary
D1	220 x 440 230 x 460 240 x 480	110 115 120	220 or 230 or 240: Connect to H1 and H4 Jumper H1 with H3 Jumper H2 with H4 440 or 460 or 480: Connect to H1 and H4 Jumper H2 with H3	Connect to X1 and X2

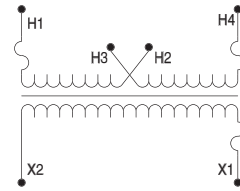

Dimensions

VA		Catalog Number	Fig.	Acc. Key	A		B		C		E		F		Slots	
UL	CE				IN	mm	IN	mm	IN	mm	IN	mm	IN	mm	IN	mm
25	25	9070TF25D1	7	I	3.09	79	3.00	76	4.00	102	2.00	51	2.50	64	0.20 x 0.38	5 x 10
50	50	9070TF50D1	7	I	3.09	79	3.00	76	4.00	102	2.00	51	2.50	64	0.20 x 0.38	5 x 10
75	75	9070TF75D1	7	I	3.34	85	3.38	86	4.18	106	2.38	61	2.81	71	0.20 x 0.48	5 x 12
100	100	9070TF100D1	7	I	3.34	85	3.38	86	4.18	106	2.38	61	2.81	71	0.20 x 0.48	5 x 12
150	150	9070TF150D1	7	I	3.59	91	3.75	95	4.50	114	2.88	73	3.13	80	0.20 x 0.38	5 x 10
200	200	9070TF200D1	7	I	3.59	91	3.75	95	4.50	114	2.88	73	3.13	80	0.20 x 0.38	5 x 10
250	160	9070TF250D1	8	I	5.30	135	3.75	95	4.50	114	2.88	73	3.13	80	0.20 x 0.38	5 x 10
300	200	9070TF300D1	8	I	4.74	120	4.50	114	5.13	130	2.56	65	3.75	95	0.20 x 0.38	5 x 10
350	250	9070TF350D1	8	I	5.11	130	4.50	114	5.13	130	3.00	76	3.75	95	0.20 x 0.38	5 x 10
500	300	9070TF500D1	8	I	5.49	139	4.50	114	5.13	130	3.56	90	3.75	95	0.20 x 0.38	5 x 10
750	500	9070TF750D1	8	I	5.61	143	5.25	133	5.80	147	3.43	87	4.38	111	0.28 x 0.56	7 x 14
1000	630	9070TF1000D1	8	I	6.30	160	5.25	133	5.80	147	4.31	109	4.38	111	0.28 x 0.56	7 x 14
1500	1000	9070TF1500D1	8	I	5.92	150	7.06	179	7.46	190	4.13	105	5.81	148	0.28 x 0.56	7 x 14
2000	1500	9070TF2000D1	8	I	7.17	182	7.06	179	7.46	190	4.56	116	5.81	148	0.28 x 0.56	7 x 14

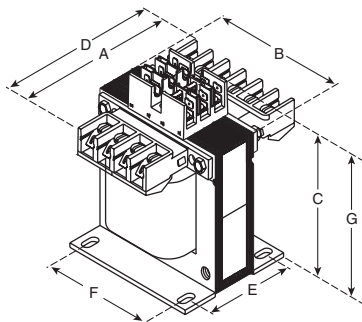

Figure 7

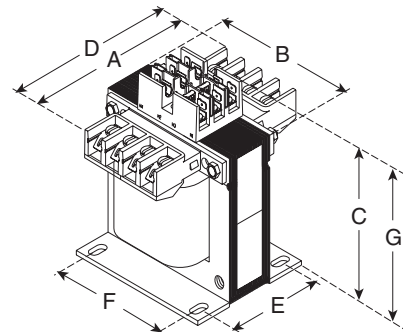

Figure 8

Square D® Type TF Transformers

Schneider Electric offers Type TF transformers with factory-installed overcurrent protection fuse blocks. The Type TF transformer consists of two primary fuse blocks and one secondary fuse block, a configuration that meets the majority of overcurrent needs by panel builders and machinery OEMs.

Since the fuse blocks are pre-wired and mounted on top of the transformer, the Type TF transformer has the same footprint as the Type T transformer. This design frees up space normally used for separate fuse blocks.

Schneider Electric also offers an extensive fuse block offering for custom applications.

VA UL/CSA/ NOM	VA CE	Catalog No.	\$ Price	H in (mm)	W in (mm)	D in (mm)	Weight (lbs)
Primary 240 x 480 Secondary 120; Primary 230 x 460 Secondary 115; or Primary 220 x 440 Secondary 110							
25	25	9070TF25D1	73.00	4.00 (101.6)	3.00 (76.2)	3.09 (78.5)	2.5
50	50	9070TF50D1	110.00	4.00 (101.6)	3.00 (76.2)	3.84 (78.5)	2.5
75	75	9070TF75D1	123.00	4.25 (107.9)	3.38 (85.8)	3.34 (84.8)	3.8
100	100	9070TF100D1	134.00	4.25 (107.9)	3.38 (85.8)	3.34 (84.8)	3.8
150	150	9070TF150D1	142.00	4.55 (115.6)	3.75 (95.3)	3.59 (91.2)	5.5
200	200	9070TF200D1	170.00	4.55 (115.6)	3.75 (95.3)	3.59 (91.2)	5.5
250	160	9070TF250D1	191.00	4.55 (115.6)	3.75 (95.3)	5.25 (133.4)	7.1
300	200	9070TF300D1	208.00	5.10 (129.6)	4.50 (114.3)	4.70 (119.4)	8.5
350	250	9070TF350D1	220.00	5.10 (129.6)	4.50 (114.3)	5.09 (129.3)	10.5
500	300	9070TF500D1	263.00	5.10 (129.6)	4.50 (114.3)	5.46 (138.7)	11.9
750	500	9070TF750D1	354.00	5.73 (145.6)	5.25 (133.4)	5.66 (143.8)	11.0
1000	630	9070TF1000D1	426.00	5.73 (145.6)	5.25 (133.4)	6.04 (153.4)	20.6
1500	1000	9070TF1500D1	589.00	7.46 (189.5)	7.06 (179.3)	5.81 (147.6)	34.0
2000	1500	9070TF2000D1	710.00	7.46 (189.5)	7.06 (179.3)	7.04 (178.8)	47.0
Primary 208 Secondary 120							
50	50	9070TF50D3	123.00	4.00 (101.6)	3.00 (76.2)	3.09 (78.5)	2.5
75	75	9070TF75D3	191.00	4.25 (107.9)	3.38 (85.8)	3.34 (84.8)	3.8
100	100	9070TF100D3	153.00	4.25 (107.9)	3.38 (85.8)	3.34 (84.8)	3.8
150	150	9070TF150D3	184.00	4.55 (115.6)	3.75 (95.3)	3.59 (91.2)	5.5
200	200	9070TF200D3	195.00	4.55 (115.6)	3.75 (95.3)	3.59 (91.2)	5.5
250	160	9070TF250D3	254.00	4.55 (115.6)	3.75 (95.3)	5.25 (133.4)	7.1
300	200	9070TF300D3	284.00	5.10 (129.6)	4.50 (114.3)	4.70 (119.4)	8.5
350	250	9070TF350D3	464.00	5.10 (129.6)	4.50 (114.3)	5.09 (129.3)	10.5
500	300	9070TF500D3	348.00	5.10 (129.6)	4.50 (114.3)	5.46 (138.7)	11.9
750	500	9070TF750D3	538.00	5.73 (145.6)	5.25 (133.4)	5.66 (143.8)	11.0
1000	630	9070TF1000D3	604.00	5.73 (145.6)	5.25 (133.4)	6.04 (153.4)	20.6
1500	1000	9070TF1500D3	806.00	7.46 (189.5)	7.06 (179.3)	5.81 (147.6)	34.0
2000	1500	9070TF2000D3	901.00	7.46 (189.5)	7.06 (179.3)	7.04 (178.8)	47.0
Primary 600 Secondary 120; Primary 575 Secondary 115; or Primary 550 Secondary 110							
50	50	9070TF50D5	123.00	4.00 (101.6)	3.00 (76.2)	3.09 (78.5)	2.5
75	75	9070TF75D5	318.00	4.25 (107.9)	3.38 (85.8)	3.34 (84.8)	3.8
100	100	9070TF100D5	153.00	4.25 (107.9)	3.38 (85.8)	3.34 (84.8)	3.8
150	150	9070TF150D5	184.00	4.55 (115.6)	3.75 (95.3)	3.59 (91.2)	5.5
200	200	9070TF200D5	195.00	4.55 (115.6)	3.75 (95.3)	3.59 (91.2)	5.5
250	160	9070TF250D5	458.00	4.55 (115.6)	3.75 (95.3)	5.25 (133.4)	7.1
300	200	9070TF300D5	284.00	5.10 (129.6)	4.50 (114.3)	4.70 (119.4)	8.5
350	250	9070TF350D5	464.00	5.10 (129.6)	4.5 (114.3)	5.09 (129.3)	10.5
500	300	9070TF500D5	348.00	5.10 (129.6)	4.50 (114.3)	5.46 (138.7)	11.9
750	500	9070TF750D5	477.00	5.73 (145.6)	5.25 (133.4)	5.66 (143.8)	11.0
1000	630	9070TF1000D5	579.00	5.73 (145.6)	5.25 (133.4)	6.04 (153.4)	20.6
1500	1000	9070TF1500D5	814.00	7.46 (189.5)	7.06 (179.3)	5.81 (147.6)	34.0
2000	1500	9070TF2000D5	939.00	7.46 (189.5)	7.06 (179.3)	7.04 (178.8)	47.0
Primary 240 x 480 Secondary 120/240; Primary 230 x 460 Secondary 115/230; or Primary 220 x 440 Secondary 110/220							
50	50	9070TF50D31	365.00	4.00 (101.6)	3.00 (76.2)	3.09 (78.5)	2.5
75	75	9070TF75D31	373.00	4.25 (107.9)	3.38 (85.8)	3.34 (84.8)	3.8
100	100	9070TF100D31	375.00	4.25 (107.9)	3.38 (85.8)	3.34 (84.8)	3.8
150	150	9070TF150D31	394.00	4.55 (115.6)	3.75 (95.3)	3.59 (91.2)	5.5
200	200	9070TF200D31	530.00	4.55 (115.6)	3.75 (95.3)	3.59 (91.2)	5.5
250	160	9070TF250D31	528.00	4.55 (115.6)	3.75 (95.3)	5.25 (133.4)	7.1
300	200	9070TF300D31	519.00	5.10 (129.6)	4.50 (114.3)	4.70 (119.4)	8.5
350	250	9070TF350D31	536.00	5.10 (129.6)	4.50 (114.3)	5.09 (129.3)	10.5
500	300	9070TF500D31	547.00	5.10 (129.6)	4.50 (114.3)	5.46 (138.7)	11.9
750	500	9070TF750D31	583.00	5.73 (145.6)	5.25 (133.4)	5.66 (143.8)	11.0
1000	630	9070TF1000D31	634.00	5.73 (145.6)	5.25 (133.4)	6.04 (153.4)	20.6
1500	1000	9070TF1500D31	880.00	7.46 (189.5)	7.06 (179.3)	5.81 (147.6)	34.0
2000	1500	9070TF2000D31	939.00	7.46 (189.5)	7.06 (179.3)	7.04 (178.8)	47.0

VA UL/CSA/ NOM	VA CE	Catalog No.	\$ Price	H in (mm)	W in (mm)	D in (mm)	Weight (lbs)
Primary 208/277/380 Secondary 95/115							
50	50	9070TF50D18	392.00	4.25 (107.9)	3.38 (87.1)	3.34 (106.4)	4.0
75	75	9070TF75D18	195.00	4.55 (115.6)	3.75 (95.3)	3.59 (91.2)	5.5
100	100	9070TF100D18	416.00	4.55 (115.6)	3.75 (95.3)	3.59 (91.2)	5.5
150	150	9070TF150D18	564.00	4.55 (115.6)	3.75 (95.3)	3.59 (91.2)	5.5
200	200	9070TF200D18	555.00	5.10 (129.6)	4.50 (114.3)	4.70 (119.4)	8.5
250	160	9070TF250D18	570.00	5.10 (129.6)	4.50 (114.3)	5.09 (129.3)	10.5
300	200	9070TF300D18	354.00	5.10 (129.6)	4.50 (114.3)	5.09 (129.3)	10.5
350	250	9070TF350D18	369.00	5.10 (129.6)	4.50 (114.3)	5.46 (138.7)	11.9
500	300	9070TF500D18	638.00	5.73 (145.6)	5.25 (133.4)	5.66 (143.8)	11.0
750	500	9070TF750D18	920.00	5.73 (145.6)	5.25 (133.4)	6.04 (153.4)	20.6
1000	630	9070TF1000D18	920.00	7.46 (189.5)	7.06 (179.3)	5.81 (147.6)	34.0
Primary 208/230/460 Secondary 115							
50	50	9070TF50D20	180.00	4.25 (107.9)	3.38 (87.1)	3.34 (106.4)	4.0
75	75	9070TF75D20	375.00	4.55 (115.6)	3.75 (95.3)	3.59 (91.2)	5.5
100	100	9070TF100D20	195.00	4.55 (115.6)	3.75 (95.3)	3.59 (91.2)	5.5
150	150	9070TF150D20	240.00	4.55 (115.6)	3.75 (95.3)	3.59 (91.2)	5.5
200	200	9070TF200D20	295.00	5.10 (129.6)	4.50 (114.3)	4.70 (119.4)	8.5
250	160	9070TF250D20	331.00	5.10 (129.6)	4.50 (114.3)	5.09 (129.3)	10.5
300	200	9070TF300D20	365.00	5.10 (129.6)	4.50 (114.3)	5.09 (129.3)	10.5
350	250	9070TF350D20	390.00	5.10 (129.6)	4.50 (114.3)	5.46 (138.7)	11.9
500	300	9070TF500D20	405.00	5.73 (145.6)	5.25 (133.4)	5.66 (143.8)	11.0
750	500	9070TF750D20	634.00	5.73 (145.6)	5.25 (133.4)	6.04 (153.4)	20.6
1000	630	9070TF1000D20	880.00	7.46 (189.5)	7.06 (179.3)	5.81 (147.6)	34.0
Primary 230/460/575 Secondary 95/115							
50	50	9070TF50D32	189.00	4.25 (107.9)	3.38 (87.1)	3.34 (106.4)	4.0
75	75	9070TF75D32	413.00	4.55 (115.6)	3.75 (95.3)	3.59 (91.2)	5.5
100	100	9070TF100D32	416.00	4.55 (115.6)	3.75 (95.3)	3.59 (91.2)	5.5
150	150	9070TF150D32	564.00	4.55 (115.6)	3.75 (95.3)	3.59 (91.2)	5.5
200	200	9070TF200D32	555.00	5.10 (129.6)	4.50 (114.3)	4.70 (119.4)	8.5
250	160	9070TF250D32	579.00	5.10 (129.6)	4.50 (114.3)	5.09 (129.3)	10.5
300	200	9070TF300D32	577.00	5.10 (129.6)	4.50 (114.3)	5.09 (129.3)	10.5
350	250	9070TF350D32	577.00	5.10 (129.6)	4.50 (114.3)	5.46 (138.7)	11.9
500	300	9070TF500D32	411.00	5.73 (145.6)	5.25 (133.4)	5.66 (143.8)	11.0
750	500	9070TF750D32	920.00	5.73 (145.6)	5.25 (133.4)	6.04 (153.4)	20.6
1000	630	9070TF1000D32	920.00	7.46 (189.5)	7.06 (179.3)	5.81 (147.6)	34.0
Primary 380/400/415 Secondary 115/230							
50	50	9070TF50D33	384.00	4.00 (101.6)	3.00 (76.2)	3.09 (78.5)	2.5
75	75	9070TF75D33	394.00	4.25 (107.9)	3.38 (85.8)	3.34 (84.8)	3.8
100	100	9070TF100D33	195.00	4.25 (107.9)	3.38 (85.8)	3.34 (84.8)	3.8
150	150	9070TF150D33	570.00	4.55 (115.6)	3.75 (95.3)	3.59 (91.2)	5.5
200	200	9070TF200D33	564.00	4.55 (115.6)	3.75 (95.3)	3.59 (91.2)	5.5
250	160	9070TF250D33	452.00	4.55 (115.6)	3.75 (95.3)	5.25 (133.4)	7.1
300	200	9070TF300D33	570.00	5.10 (129.6)	4.50 (114.3)	4.70 (119.4)	8.5
350	250	9070TF350D33	498.00	5.10 (129.6)	4.50 (114.3)	5.09 (129.3)	10.5
500	300	9070TF500D33	638.00	5.10 (129.6)	4.50 (114.3)	5.46 (138.7)	11.9
750	500	9070TF750D33	668.00	5.73 (145.6)	5.25 (133.4)	5.66 (143.8)	11.0
1000	630	9070TF1000D33	920.00	5.73 (145.6)	5.25 (133.4)	6.04 (153.4)	20.6
Primary 240/416/480/600 Secondary 99/120/130; Primary 230/400/460/575 Secondary 95/115/125 Primary 220/380/440/550 Secondary 90/110/120; Primary 208/360/416/520 Secondary 85/104/115							
50	50	9070TF50D50	274.00	4.25 (107.9)	3.43 (87.1)	4.19 (106.4)	4.0
75	75	9070TF75D50	290.00	4.55 (115.6)	3.75 (95.3)	4.88 (124)	7.2
100	100	9070TF100D50	297.00	4.55 (115.6)	3.75 (95.3)	5.25 (133.4)	7.1
150	150	9070TF150D50	312.00	5.10 (129.6)	4.50 (114.3)	4.70 (119.4)	8.5
200	200	9070TF200D50	341.00	5.10 (129.6)	4.50 (114.3)	5.09 (129.3)	10.5
250	160	9070TF250D50	429.00	5.10 (129.6)	4.50 (114.3)	5.09 (129.3)	10.5
300	200	9070TF300D50	394.00	5.10 (129.6)	4.50 (114.3)	5.46 (138.7)	11.9
350	250	9070TF350D50	405.00	5.73 (145.6)	5.25 (133.4)	5.66 (143.8)	11.0
500	300	9070TF500D50	502.00	5.73 (145.6)	5.25 (133.4)	5.66 (143.8)	11.0
750	500	9070TF750D50	572.00	5.73 (145.6)	5.25 (133.4)	6.04 (153.4)	20.6
1000	630	9070TF1000D50	727.00	7.46 (189.5)	7.06 (179.3)	5.81 (147.6)	34.0

14 TRANSFORMERS