

Inductive Sensors

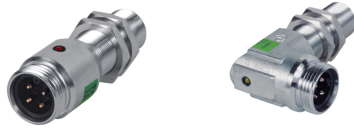
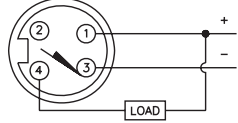
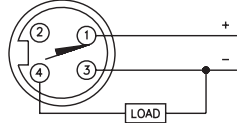
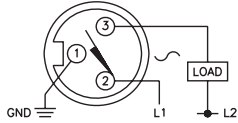
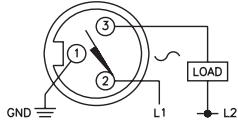
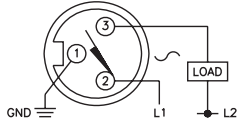
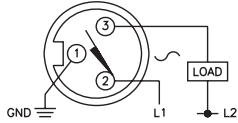

Housing Style	Part Number	ID Number	Features	Sensing Range (mm)	Output
18 mm - Embeddable, minifast® Connection 	Bi 5-G18-AN6X-B1341	T4695200		5	3-Wire DC NPN
	Bi 5-G18-AP6X-B1341	T4696300		5	3-Wire DC PNP
	Bi 5-G18-AP6X-B1341/S34	M4691800	WFI	5	
18 mm - Embeddable, Right Angle, minifast Connection 	Bi 5-G18-AN6X-B1441	T4695600		5	3-Wire DC NPN
	Bi 5-G18-AP6X-B1441	T4696700		5	3-Wire DC PNP
	Bi 5-G18-AP6X-B1441/S34	M4691900	WFI	5	
18 mm - Embeddable, minifast Connection 	Bi 5-G18-ADZ30X2-B1331	T4208000		5	2-Wire AC/DC Short-Circuit Protected
	Bi 5U-G18-ADZ30X2-B1331	M4281212	Uprox	5	
	Bi 5-G18-AZ3X-B1331	T4372000		5	2-Wire AC/DC
18 mm - Embeddable, minifast Connection, Teflon Coated 	Bi 5-GT18-ADZ30X2-B1331	T4255290		5	2-Wire AC/DC Short-Circuit Protected
	Bi 5-GT18-ADZ30X2-B1331/S34	T4255200	WFI	5	
	Bi 5-GT18H-ADZ30X2-B1331/S34/S1589	T4255284	weldguard®, WFI	5	
	Bi 5U-GT18-ADZ30X2-B1331	M4281222	Uprox	5	

Output	Switching Freq. (Hz)	Operating Current (mA) VAC/VDC	Operating Temp. (°C)	Protection	Housing	Face	Power LED	Output LED	Mating Cordset	Wiring Diagram #	Wiring Diagrams
10-30 VDC	1000	≤200	-25 to +70	IP 67	CPB	PA 12	N/A	YE	RKM 40-*M	1	Diagram 1 
	1000	≤200	-25 to +70	IP 67	CPB	PA 12	N/A	YE	RKM 40-*M	2	
10-30 VDC	1000	≤200	-25 to +70	IP 67	CPB	PA 12	N/A	YE	RKM 40-*M	2	Diagram 2 
	1000	≤200	-25 to +70	IP 67	CPB	PA 12	N/A	YE	RKM 40-*M	2	
10-30 VDC	1000	≤200	-25 to +70	IP 67	CPB	PA 12	N/A	YE	RKM 40-*M	1	Diagram 3 
10-30 VDC	1000	≤200	-25 to +70	IP 67	CPB	PA 12	N/A	YE	RKM 40-*M	2	
20-250 VAC 10-300 VDC	20	≤400/300	-25 to +70	IP 67	CPB	PA 12	GN	RD	RKM 30-*M	3	Diagram 3 
	20	≤400/300	-30 to +85	IP 67	CPB	PA 12	GN	YE	RKM 30-*M	3	
20-250 VAC 10-300 VDC	20	≤400/300	-25 to +70	IP 67	CPB	PA 12	N/A	RD	RKM 30-*M	3	Diagram 3 
20-250 VAC 10-300 VDC	20	≤400/300	-25 to +70	IP 67	TC	TC	GN	RD	RKM 30-*M	3	
20-250 VAC 10-300 VDC	20	≤400/300	-25 to +70	IP 67	TC	TC	GN	RD	RKM 30-*M	3	Diagram 3 
	20	≤400/300	-25 to +70	IP 67	TC	WG	GN	RD	RKM 30-*M	3	
	20	≤400/300	-25 to +70	IP 67	TC	TC	GN	YE	RKM 30-*M	3	
	20	≤400/300	-30 to +85	IP 67	TC	TC	GN	YE	RKM 30-*M	3	

* Length in meters.

WIRING DIAGRAM

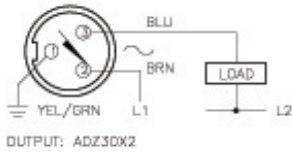

SHORT-CIRCUIT AND OVERLOAD PROTECTED

LOCKNUT LN-MT18

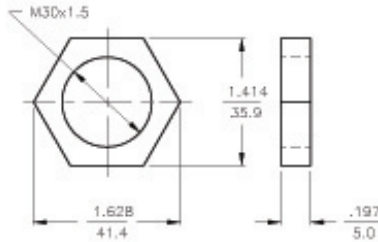

SPECIFICATIONS

OPERATING VOLTAGE	20-250 VAC 10-300 VDC
LINE FREQUENCY	40-60 Hz
DIFFERENTIAL TRAVEL (HYSTERESIS)	3-15% (5% TYPICAL)
VOLTAGE DROP ACROSS CONDUCTING SENSOR	≤ 6.0 V at 400 mA
OUTPUT FUNCTION -ADZ	NORMALLY OPEN 2-WIRE AC/DC SELF-CONTAINED
SHORT-CIRCUIT PROTECTED	YES
TRIGGER CURRENT FOR OVERLOAD PROTECTION	≥ 440 mA
CONTINUOUS LOAD CURRENT	400 mA AC MAX. 300 mA DC MAX.
OFF-STATE (LEAKAGE) CURRENT	≤ 1.7 mA
MINIMUM LOAD CURRENT	≥ 3.0 mA
INRUSH CURRENT	≤ 4 A (≤ 20 ms/5 Hz)
TIME DELAY BEFORE AVAILABILITY	≤ 120 ms
POWER-ON EFFECT PROTECTION	INCORPORATED
PROTECTION AGAINST TRANSIENTS	EN 60947-5-2
OPERATING TEMPERATURE	-25°C to +70°C (±10% DRIFT) -30°C to +85°C (±15% DRIFT)
ENCLOSURE	MEETS NEMA 1, 3, 4, 6, 13 AND IEC IP67
SHOCK	30 g, 11 ms
VIBRATION	55 Hz, 1 mm AMPLITUDE (IN ALL 3 PLANES)
LED FUNCTION	GREEN: STEADY-POWER ON FLASHING = SHORT-CIRCUIT WARNING YELLOW: OUTPUT ENERGIZED
RATED OPERATING DISTANCE(Sn)	5 mm = .197" (NOMINAL)
SWITCHING FREQUENCY	60 Hz
REPEATABILITY	≤ 2% OF RATED OPERATING DISTANCE
EMBEDDABLE (SHIELDED)	YES
MATING PLUGS/CABLES	3-PIN "MINIFAST" CONSTRUCTION

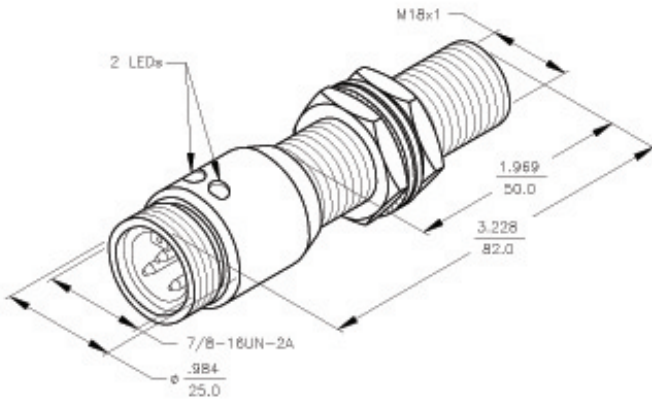

NOTES:

- WELD FIELD IMMUNE. SENSORS IS SUITABLE FOR USE ON RESISTANCE WELDING MACHINES.
- MATERIALS:
CHROME PLATED BRASS CONNECTOR,
TEFLON COATED BRASS LOCKNUTS,
BLACK CHROMATED STEEL LOCKWASHERS,
TEFLON COATED PA 12-GF30 PLASTIC SENSING FACE.

RELATED DOCUMENTS 1. 2. 3. 4.	3RD ANGLE PROJECTION 	THIS DRAWING IS PROPERTY OF TURCK INC. USE OF THIS DOCUMENT WITHOUT WRITTEN PERMISSION IS PROHIBITED.		TURCK INC High Technology Sensors and Automation Controls	
MATERIAL SEE NOTE 2	TOLERANCES UNLESS OTHERWISE SPECIFIED .X ± 0.02 .XX ± 0.01 .XXX ± 0.005 ANGLES ± 1° ALL MILLIMETER DIMENSIONS ARE REFERENCE ONLY	DWGT USDR	CBM	DATE 7/14/87	DESCRIPTION BISU-G18-ADZ3DX2-B1331
FRESH		UNIT OF MEASUREMENT INCH [MILLIMETER]		IDENTIFICATION NO. M4281212	REV B
B UPDATE TO CURRENT TITLE BLOCK	RDS 09/12/02 5504	DO NOT SCALE THIS DRAWING		FILE: M4281212	SHEET 1 OF 1