

### FD7-10

#### Description:

The FD7-10 Quick Pack small power transformer offers a significant reduction in size and weight over a standard transformer. This transformer can be used for a wide variety of applications. It is bobbin wound for reduced size and small operating space.

#### Electrical Specifications (@25C):

**Maximum Power:** 56.0VA

**Input Voltage:**

**Series:** 230VAC@50/60Hz

**Parallel:** 115VAC@50/60Hz

**Output Voltage:** 10.0VCT@5.0A

#### Construction:

Split bobbin non concentric winding eliminates costly electrostatic shielding. Termination is suitable for quick connects or soldering.

#### Safety:

UL Class B E53148



#### Dimensions:

A	B	C	D	E	F	G
2.250	3.125	3.687	1.812	2.687	.187 Dia	1.062

- Notes:**
- Units: inches.
  - Terminal size: .187" X 0.21".
  - Weight: 1.70 lbs

#### Schematic:

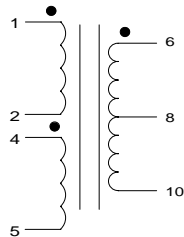

**Input (115V):** Input 1 to 2  
Connect 1 to 4, 2 to 5

**Input (230V):** Input 1 to 5  
Connect 2 to 4

**Output:** 6 to 10

**RoHS Compliance:** As of manufacturing date February 2005, all standard products meet the requirements of 2002/95/EC, known as the RoHS initiative.

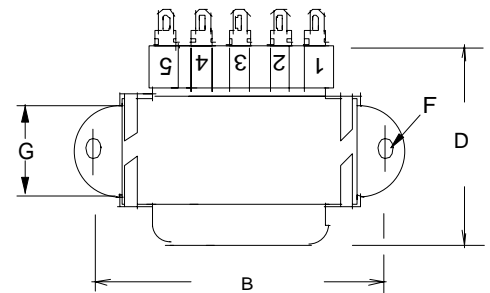
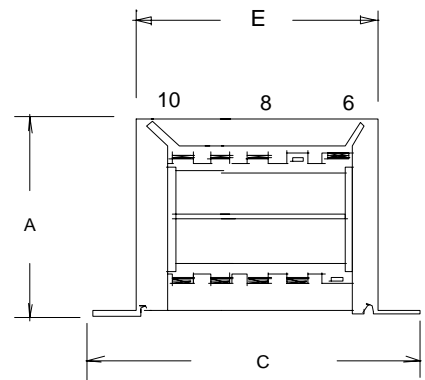

# Power Transformers

Class B  
UL Recognized



UL File E53148

## Chassis Mount: Quick Pack™

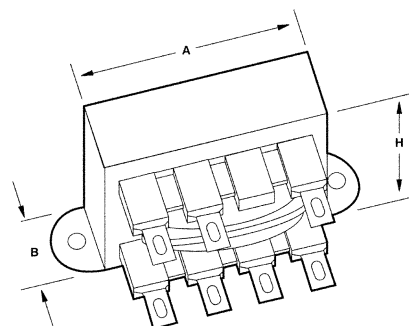

### :: Description

The Triad Quick Pack small power transformer series offers a significant reduction in size and weight for a given VA rating. These transformers are available in six sizes for a wide variety of applications. They are bobbin wound for reduced size and small operating space. Split bobbin nonconcentric winding eliminates costly electrostatic shielding. Termination is suitable for quick connects or soldering.

### :: Specifications

**Primary:** 115 V, 115/230 V, 50/60 Hz

**VA Range:** 2.4 to 100.0

**Output Rating Range:** 10.0 V CT to 120.0 V CT

### :: Quick Pack

Section	Single Primary 115 V	Dual Primary 115/230 V	VA	Output Rating	Dimensions						Wt. Lbs.
					L	W	H	A	B	ML	
A	F3-10	•	2.4	10.0V CT @ 0.25A	2 <sup>1</sup> / <sub>16</sub>	1 <sup>1</sup> / <sub>16</sub>	1 <sup>1</sup> / <sub>16</sub>	1 <sup>3</sup> / <sub>8</sub>	<sup>5</sup> / <sub>16</sub>	1 <sup>3</sup> / <sub>4</sub>	0.25
	F3-12	•		12.6V CT @ 0.2A							
	F3-16	•		16.0V CT @ 0.15A							
	F3-20	•		20.0V CT @ 0.12A							
	F3-24	•		24.0V CT @ 0.1A							
	F3-28	•		28.0V CT @ 0.085A							
	F3-36	•		36.0V CT @ 0.065A							
	F3-48	•		48.0V CT @ 0.05A							
	F3-56	•		56.0V CT @ 0.045A							
	F3-120	•		120.0V CT @ 0.02A							
B	F4-10	FD4-10	6.0	10.0V CT @ 0.6A	2 <sup>7</sup> / <sub>8</sub>	1 <sup>1</sup> / <sub>4</sub>	1 <sup>3</sup> / <sub>8</sub>	1 <sup>1</sup> / <sub>16</sub>	<sup>1</sup> / <sub>16</sub>	2	0.44
	F4-12	FD4-12		12.6V CT @ 0.5A							
	F4-16	FD4-16		16.0V CT @ 0.4A							
	F4-20	FD4-20		20.0V CT @ 0.3A							
	F4-24	FD4-24		24.0V CT @ 0.25A							
	F4-28	FD4-28		28.0V CT @ 0.2A							
	F4-36	FD4-36		36.0V CT @ 0.17A							
	F4-48	FD4-48		48.0V CT @ 0.125A							
	F4-56	FD4-56		56.0V CT @ 0.11A							
	F4-120	FD4-120		120.0V CT @ 0.05A							
C	F5-10	FD5-10	12.0	10.0V CT @ 1.2A	2 <sup>5</sup> / <sub>16</sub>	1 <sup>3</sup> / <sub>8</sub>	1 <sup>3</sup> / <sub>8</sub>	1 <sup>5</sup> / <sub>16</sub>	<sup>3</sup> / <sub>16</sub>	2 <sup>3</sup> / <sub>8</sub>	0.70
	F5-12	FD5-12		12.6V CT @ 1.0A							
	F5-16	FD5-16		16.0V CT @ 0.8A							
	F5-20	FD5-20		20.0V CT @ 0.6A							
	F5-24	FD5-24		24.0V CT @ 0.5A							
	F5-28	FD5-28		28.0V CT @ 0.42A							
	F5-36	FD5-36		36.0V CT @ 0.35A							
	F5-48	FD5-48		48.0V CT @ 0.25A							
	F5-56	FD5-56		56.0V CT @ 0.22A							
	F5-120	FD5-120		120.0V CT @ 0.1A							
D	F6-10	FD6-10	30.0	10.0V CT @ 3.0A	3 <sup>1</sup> / <sub>4</sub>	1 <sup>1</sup> / <sub>16</sub>	1 <sup>5</sup> / <sub>16</sub>	2 <sup>7</sup> / <sub>16</sub>	1 <sup>1</sup> / <sub>16</sub>	2 <sup>5</sup> / <sub>16</sub>	1.10
	F6-12	FD6-12		12.6V CT @ 2.5A							
	F6-16	FD6-16		16.0V CT @ 2.0A							
	F6-20	FD6-20		20.0V CT @ 1.5A							
	F6-24	FD6-24		24.0V CT @ 1.25A							
	F6-28	FD6-28		28.0V CT @ 1.1A							
	F6-36	FD6-36		36.0V CT @ 0.85A							
	F6-48	FD6-48		48.0V CT @ 0.63A							
	F6-56	FD6-56		56.0V CT @ 0.54A							
	F6-120	FD6-120		120.0V CT @ 0.25A							
E	F7-10	FD7-10	56.0	10.0V CT @ 5.0A	3 <sup>1</sup> / <sub>16</sub>	1 <sup>5</sup> / <sub>16</sub>	2 <sup>1</sup> / <sub>4</sub>	2 <sup>1</sup> / <sub>16</sub>	1 <sup>1</sup> / <sub>16</sub>	3 <sup>3</sup> / <sub>8</sub>	1.70
	F7-12	FD7-12		12.6V CT @ 4.0A							
	F7-16	FD7-16		16.0V CT @ 3.5A							
	F7-20	FD7-20		20.0V CT @ 2.8A							
	F7-24	FD7-24		24.0V CT @ 2.4A							
	F7-28	FD7-28		28.0V CT @ 2.0A							
	F7-36	FD7-36		36.0V CT @ 1.5A							
	F7-48	FD7-48		48.0V CT @ 1.2A							
	F7-56	FD7-56		56.0V CT @ 1.0A							
	F7-120	FD7-120		120.0V CT @ 0.5A							

CT = Center Tap    Mounting hole size: <sup>3</sup>/<sub>16</sub>"

**:: Quick Pack continued**

Section	Single Primary 115 V	Dual Primary 115/230 V	VA	Output Rating	Dimensions						Wt. Lbs.
					L	W	H	A	B	ML	
A	F8-10	F8-10	100.0	10.0V CT @ 10.0A	4 <sup>1</sup> / <sub>32</sub>	2 <sup>1</sup> / <sub>4</sub>	2 <sup>1</sup> / <sub>16</sub>	3 <sup>1</sup> / <sub>16</sub>	1 <sup>1</sup> / <sub>16</sub>	3 <sup>1</sup> / <sub>16</sub>	2.75
	F8-12	F8-12		12.6V CT @ 8.0A							
	F8-16	F8-16		16.0V CT @ 6.25A							
	F8-20	F8-20		20.0V CT @ 5.0A							
	F8-24	F8-24		24.0V CT @ 4.0A							
	F8-28	F8-28		28.0V CT @ 3.6A							
	F8-36	F8-36		36.0V CT @ 2.8A							
	F8-48	F8-48		48.0V CT @ 2.0A							
	F8-56	F8-56		56.0V CT @ 1.8A							
	F8-120	F8-120		120.0V CT @ 0.85A							

CT = Center Tap    Mounting hole size: <sup>1</sup>/<sub>16</sub>"

**:: Outline Dimensions**

**Technical Notes**

1. Hi-pot tested at 2,500 VRMS.
2. Class B insulation for maximum temperature of 130°C.
3. Terminal size is .187" x .021".

