

Features

- Fit automatic placement equipment.
- Fit Compatible with infrared and vapor phase reflow solder process.
- Pb-free.
- RoHS compliant.

Descriptions

- For higher packing density .
- For minature applications .
- Water clear lens .
- Chip material : AlGaInP .
- Emitting color : Red .

Package Outline Dimensions

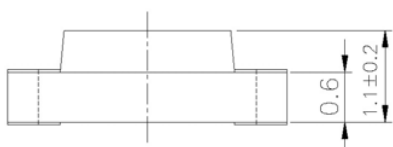
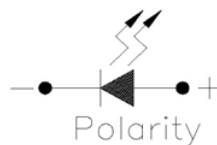
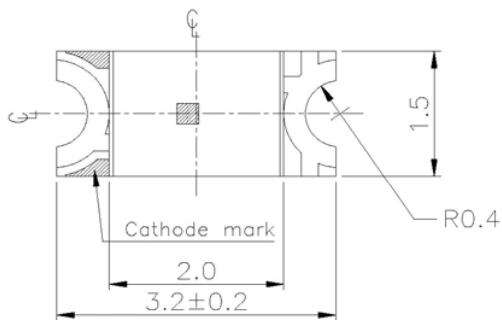

For reflow soldering (propose)

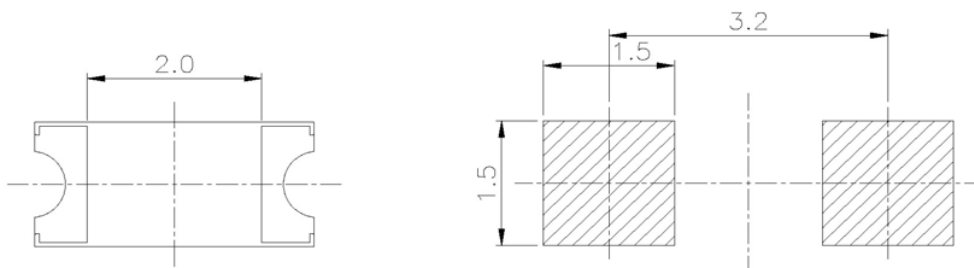

Note: The tolerances unless mentioned is $\pm 0.1\text{mm}$,Unit = mm



Absolute Maximum Ratings (Ta=25°C)

| Parameter | Symbol | Rating | Unit |
|---|------------------|---|------|
| Reverse Voltage | V _R | 5 | V |
| Forward Current | I _F | 25 | mA |
| Operating Temperature | T _{opr} | -40 ~ +85 | °C |
| Storage Temperature | T _{stg} | -40~ +90 | °C |
| Electrostatic Discharge(HBM) | ESD | 2000 | V |
| Power Dissipation | P _d | 60 | mW |
| Peak Forward Current (Duty 1/10 @1KHz) | I _F | 60 | mA |
| Soldering Temperature | T _{sol} | Reflow Soldering : 260 °C for 10 sec. Hand Soldering : 350 °C for 3 sec. | |

Electro-Optical Characteristics (Ta=25°C)

| Parameter | Symbol | *Chip Rank | Min. | Typ. | Max. | Unit | Condition |
|------------------------------|----------------|------------|-------|-------|-------|------|-----------------------|
| Luminous Intensity | I _v | A2 | 15 | 38 | | mcd | I _F =20 mA |
| | | A3 | 36 | 54 | ----- | | |
| | | A4 | 49 | 74 | ----- | | |
| | | A5 | 60 | 92 | ----- | | |
| | | A6 | 72 | 111 | ----- | | |
| | | A7 | 85 | 133 | ----- | | |
| Viewing Angle | 2θ 1/2 | ----- | ----- | 130 | ----- | deg | |
| Peak Wavelength | λ _p | ----- | ----- | 632 | ----- | nm | |
| Dominant Wavelength | λ _d | ----- | ----- | 624 | ----- | nm | |
| Spectrum Radiation Bandwidth | Δλ | ----- | ----- | 20 | ----- | nm | |
| Forward Voltage | V _F | ----- | 1.7 | 2.0 | 2.4 | V | |
| Reverse Current | I _R | ----- | ----- | ----- | 10 | μA | V _R =5V |

Specific binning requirements- please contact our home office

Typical Electro-Optical Characteristics

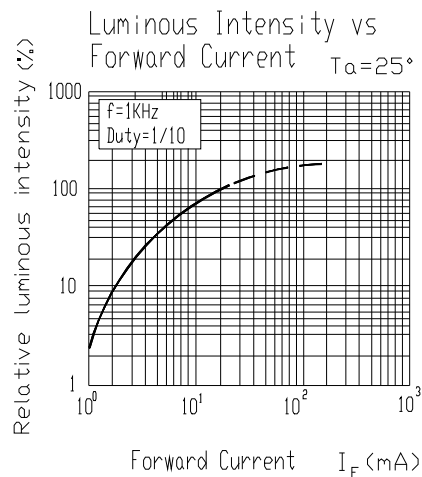
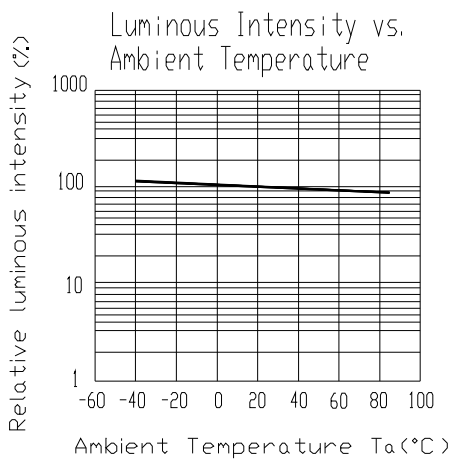
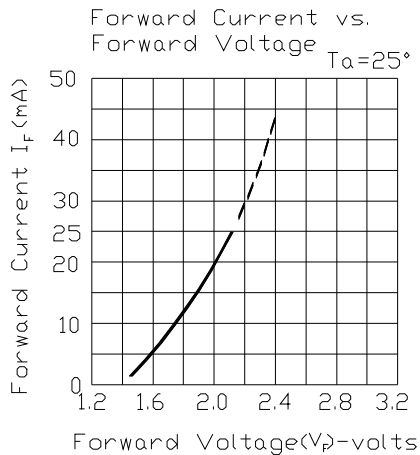
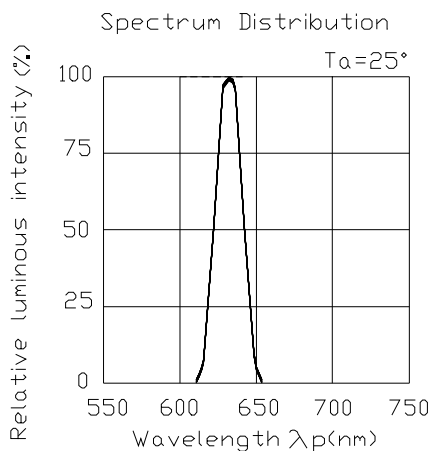

Forward Current Derating Curve

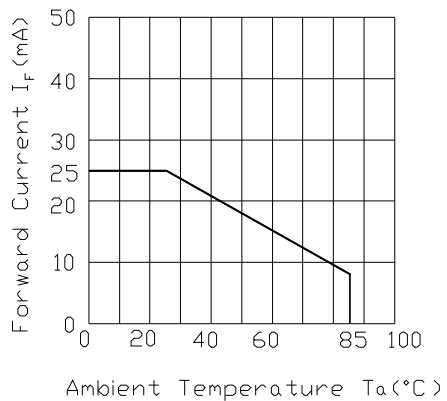

Radiation Diagram

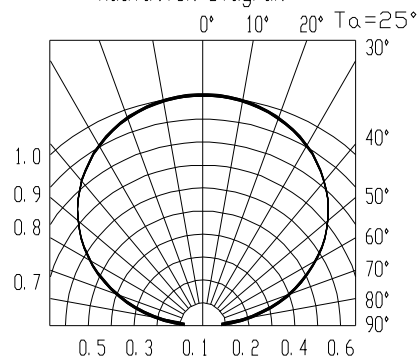

Reel Dimensions

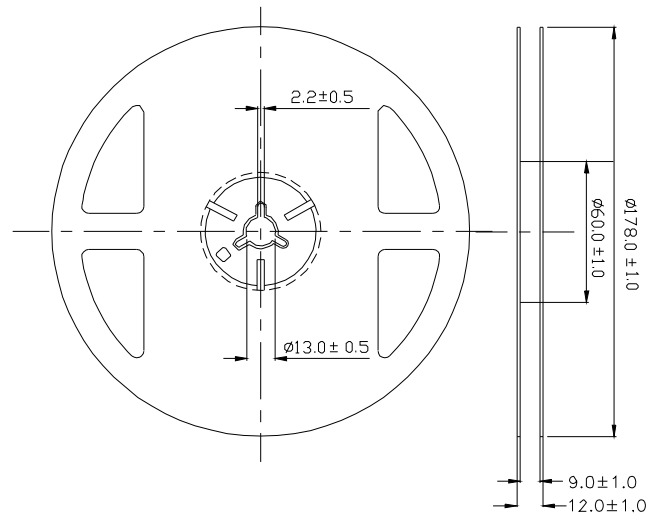

Note: The tolerances unless mentioned is ± 0.1 mm ,Unit = mm

Carrier Tape Dimensions: Loaded quantity 2000 PCS per reel

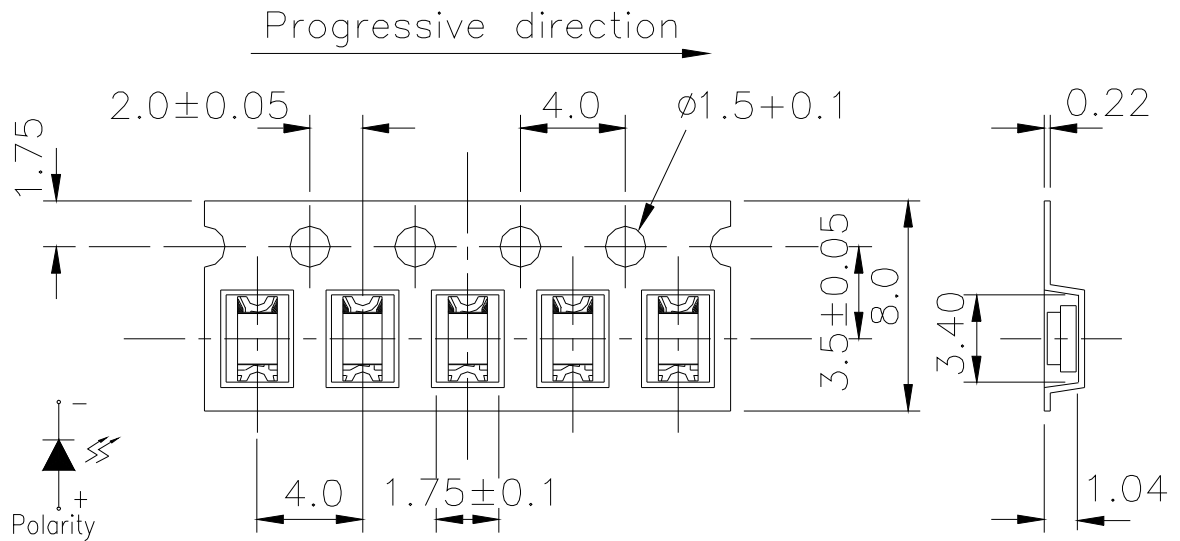

Note: Tolerances Unless Dimension is ±0.1mm , Unit = mm

Moisture Resistant Packaging

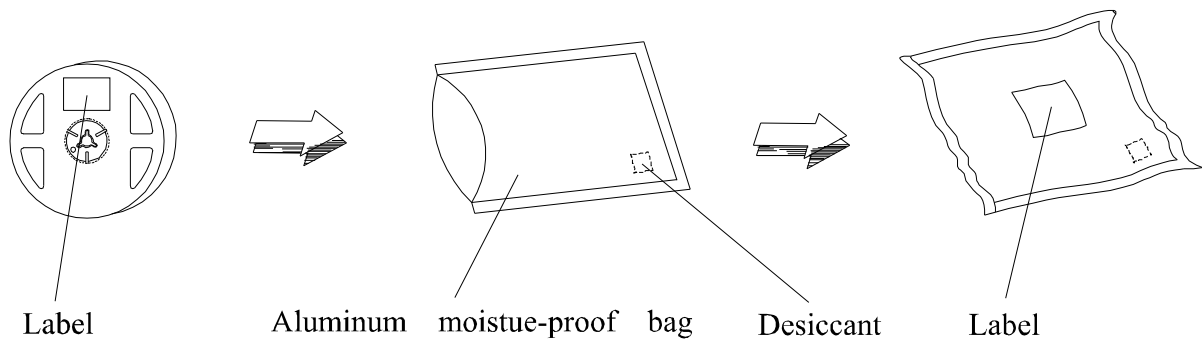

Soldering Condition

1. Pb-free solder temperature profile

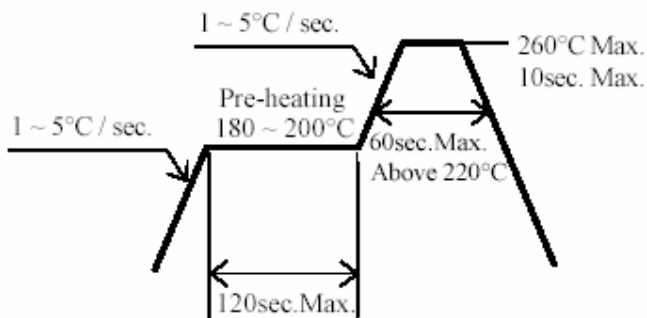

2. Reflow soldering should not be done more than two times.
3. When soldering, do not put stress on the LEDs during heating.
4. After soldering, do not warp the circuit board.

Soldering Iron

Each terminal is to go to the tip of soldering iron temperature less than 350°C for 3 seconds within once in less than the soldering iron capacity 25W. Leave two seconds and more intervals, and do soldering of each terminal. Be careful because the damage of the product is often started at the time of the hand solder.