

## Magnecraft

### Item # W49RE1C1VG-5DC-SCO, 49 PCB Mount Enclosed Relay/SPDT 3 - 10 Amp Rated

#### 49 PCB Mount Enclosed Relay/SPDT 3 - 10 Amp Rated

Electronic control circuits built on PCB's demand relays that can be populated with the same machinery currently used in the production lines. The Magnecraft SIPS and DIPS are built in small industry standard package styles that do not require unique machinery to populate. The SIPS and DIPS can even withstand a lead-free solder re-flow process so a pin-thru-paste application is possible.

Up to 1/3 HP 120VAC Switching  
UL Recognized  
Can Be Configured in a Variety of Contact Materials and Mounting Styles

This item is normally stocked

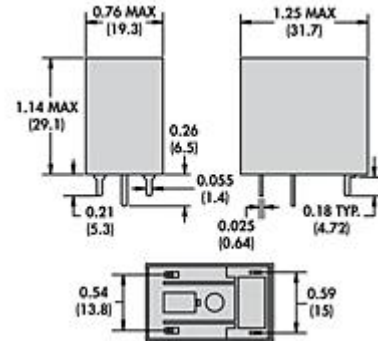

[SPECIFICATIONS](#) · [CONTACT CHARACTERISTICS](#) · [COIL CHARACTERISTICS](#) · [PERFORMANCE CHARACTERISTICS](#) · [ENVIRONMENT](#)

#### SPECIFICATIONS

Footprint	Narrow Footprint
Control	DC
Contact Configuration	SPDT-NC SPDT-NO
Nominal Input Voltage	12 VDC
Coil Resistance	1350 Ohm

#### CONTACT CHARACTERISTICS

Contact Materials	Silver Alloy
Current Rating	5 A
Switching Voltage (AC)	120 V 50 / 60 Hz
Switching Voltage (DC)	28 V
Switching Voltage	1/3 hp at 240 VAC (Normally Open) 1/4 hp at 277 VAC (Normally Open) 1/6 hp at 240 VAC (Normally Closed) 1/8 hp at 277 VAC (Normally Closed)
Switching Voltage (Pilot Duty)	B300 (120 / 240 VAC)

## COIL CHARACTERISTICS

Operating Range - % of Nominal (DC)	75 to 120 %
Average Consumption (DC)	0.11 W
Drop-out Voltage Threshold (DC)	10 %

## PERFORMANCE CHARACTERISTICS

Electrical Life, Operations at Rated Current (Resistive)	100000
Mechanical Life, Unpowered	50000000
Operating Time (Response Time)	25 ms

## ENVIRONMENT

Product Certifications	UL
Ambient Air Temperature around the Device - Storage	-40 to +85 °C
Ambient Air Temperature around the Device - Operation	-40 to +55 °C
Vibration Resistance - Operational	3 g-n at 10-55 Hz
Shock Resistance	10 g-n