

## M12-Round-Plug Connector According to IEC 61076-2-101 M12-Cordsets

### RST-RKT | RST-RKWT



Actuator-/Sensor Double-Ended Cordset, M12, Male to Female Straight and Male to Female 90° 3-, 4- and 5-Pole, yellow PUR, PVC and TPE cable, EURO DC Color Code, IP 68 and NEMA 6P rated.

Cable Types: 18 AWG  
731 | 637 = TPE, yellow  
645 | 602 = PUR, yellow

Cable Types: 22 AWG  
632 | 633 | 612 = PVC, yellow  
610 | 679 | 644 = PUR, yellow  
643 = TPE, yellow

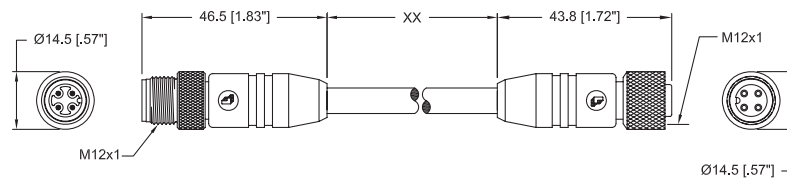



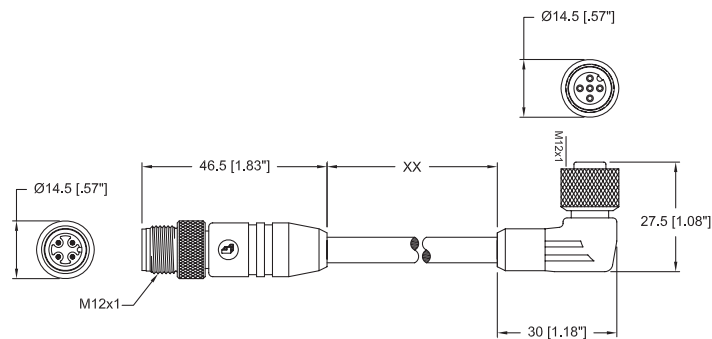



### RST 4-RKT 4 - Male to Female Straight



### RST 4 - RKWT 4 - Male Straight to Female 90°

### Pin Assignments - M12

3-Pole		4-Pole		5-Pole	
					
1 = brown	1 = brown	1 = brown	1 = brown	1 = brown	1 = brown
3 = blue	2 = white	2 = white	2 = white	2 = white	2 = white
4 = black	3 = blue	3 = blue	3 = blue	3 = blue	3 = blue
	4 = black	4 = black	4 = black	4 = black	4 = black
	5 = grey			5 = grey	5 = grey

### Technical Specifications

#### Materials

Molded Body	Polyurethane, yellow
Coupling Nut plated	Brass, nickel
Contacts	Brass, gold plated
Insert	Polyurethane
O-ring	Viton

#### Electrical

Current Rating	4A
Voltage Rating	250V

#### Mechanical

Temperature Protection	-40°C To 90°C IP 68, NEMA 6P
------------------------	---------------------------------

### Part Numbers

RST 3-RKT 4-3-731/0,3 M	RST 4-RKT 4-643/0,3 M
RST 3-RKT 4-3-731/0,6 M	RST 4-RKT 4-643/0,6 M
RST 3-RKT 4-3-731/1 M	RST 4-RKT 4-643/1 M
RST 3-RKT 4-3-731/2 M	RST 4-RKT 4-643/2 M
RST 3-RKT 4-3-731/5 M	RST 4-RKT 4-643/3 M
RST 3-RKT 4-3-632/0,3 M	RST 4-RKT 4-643/5 M
RST 3-RKT 4-3-632/0,6 M	RST 4-RKT 4-602/0,3 M
RST 3-RKT 4-3-632/1 M	RST 4-RKT 4-602/0,6 M
RST 3-RKT 4-3-632/2 M	RST 4-RKT 4-602/1 M
RST 3-RKT 4-3-632/5 M	RST 4-RKT 4-602/2 M
RST 3-RKT 4-3-645/0,3 M	RST 4-RKT 4-602/3 M
RST 3-RKT 4-3-645/0,6 M	RST 4-RKT 4-602/5 M
RST 3-RKT 4-3-645/1 M	RST 4-RKT 4-679/0,3 M
RST 3-RKT 4-3-645/2 M	RST 4-RKT 4-679/0,6 M
RST 3-RKT 4-3-645/5 M	RST 4-RKT 4-679/1 M
RST 3-RKT 4-3-610/0,3 M	RST 4-RKT 4-679/2 M
RST 3-RKT 4-3-610/0,6 M	RST 4-RKT 4-679/3 M
RST 3-RKT 4-3-610/1 M	RST 4-RKT 4-679/5 M
RST 3-RKT 4-3-610/2 M	RST 5-RKT 5-612/0,3 M
RST 3-RKT 4-3-610/5 M	RST 5-RKT 5-612/0,6 M
RST 4-RKT 4-637/0,3 M	RST 5-RKT 5-612/1 M
RST 4-RKT 4-637/0,6 M	RST 5-RKT 5-612/2 M
RST 4-RKT 4-637/1 M	RST 5-RKT 5-612/5 M
RST 4-RKT 4-637/2 M	RST 5-RKT 5-644/0,3 M
RST 4-RKT 4-637/3 M	RST 5-RKT 5-644/0,6 M
RST 4-RKT 4-637/5 M	RST 5-RKT 5-644/1 M
RST 4-RKT 4-633/0,3 M	RST 5-RKT 5-644/2 M
RST 4-RKT 4-633/0,6 M	RST 5-RKT 5-644/5 M
RST 4-RKT 4-633/1 M	
RST 4-RKT 4-633/2 M	
RST 4-RKT 4-633/3 M	
RST 4-RKT 4-633/5 M	

### Part Numbers

RST 3-RKWT 4-3-731/0,3 M	RST 4-RKWT 4-643/0,3 M
RST 3-RKWT 4-3-731/0,6 M	RST 4-RKWT 4-643/0,6 M
RST 3-RKWT 4-3-731/1 M	RST 4-RKWT 4-643/1 M
RST 3-RKWT 4-3-731/2 M	RST 4-RKWT 4-643/2 M
RST 3-RKWT 4-3-731/5 M	RST 4-RKWT 4-643/3 M
RST 3-RKWT 4-3-632/0,3 M	RST 4-RKWT 4-643/5 M
RST 3-RKWT 4-3-632/0,6 M	RST 4-RKWT 4-602/0,3 M
RST 3-RKWT 4-3-632/1 M	RST 4-RKWT 4-602/0,6 M
RST 3-RKWT 4-3-632/2 M	RST 4-RKWT 4-602/1 M
RST 3-RKWT 4-3-632/5 M	RST 4-RKWT 4-602/2 M
RST 3-RKWT 4-3-645/0,3 M	RST 4-RKWT 4-602/3 M
RST 3-RKWT 4-3-645/0,6 M	RST 4-RKWT 4-602/5 M
RST 3-RKWT 4-3-645/1 M	RST 4-RKWT 4-679/0,3 M
RST 3-RKWT 4-3-645/2 M	RST 4-RKWT 4-679/0,6 M
RST 3-RKWT 4-3-645/5 M	RST 4-RKWT 4-679/1 M
RST 3-RKWT 4-3-610/0,3 M	RST 4-RKWT 4-679/2 M
RST 3-RKWT 4-3-610/0,6 M	RST 4-RKWT 4-679/3 M
RST 3-RKWT 4-3-610/1 M	RST 4-RKWT 4-679/5 M
RST 3-RKWT 4-3-610/2 M	RST 5-RKWT 5-612/0,3 M
RST 3-RKWT 4-3-610/5 M	RST 5-RKWT 5-612/0,6 M
RST 4-RKWT 4-637/0,3 M	RST 5-RKWT 5-612/1 M
RST 4-RKWT 4-637/0,6 M	RST 5-RKWT 5-612/2 M
RST 4-RKWT 4-637/1 M	RST 5-RKWT 5-612/5 M
RST 4-RKWT 4-637/2 M	RST 5-RKWT 5-644/0,3 M
RST 4-RKWT 4-637/3 M	RST 5-RKWT 5-644/0,6 M
RST 4-RKWT 4-637/5 M	RST 5-RKWT 5-644/1 M
RST 4-RKWT 4-633/0,3 M	RST 5-RKWT 5-644/2 M
RST 4-RKWT 4-633/0,6 M	RST 5-RKWT 5-644/5 M
RST 4-RKWT 4-633/1 M	
RST 4-RKWT 4-633/2 M	
RST 4-RKWT 4-633/3 M	
RST 4-RKWT 4-633/5 M	

### Cable Specifications

Poles	Cable No.	Material	Gauge	Jacket Color	Overall Diameter	UL Recognition
3	610	PUR	22	Yellow	.190"	AWM 20233
	632	PVC	22	Yellow	.190"	AWM 2661
	645	PUR	18	Yellow	.220"	AWM 20233
	731	TPE	18	Yellow	.261"	AWM 20327, PLTC
4	602	PUR	18	Yellow	.230"	AWM 20233
	633	PVC	22	Yellow	.190"	AWM 2661
	637	TPE	18	Yellow	.280"	AWM 20327, PLTC
	643	TPE	22	Yellow	.246"	AWM 20327, PLTC
	679	PUR	22	Yellow	.190"	AWM 20233
5	612	PVC	22	Yellow	.210"	AWM 2661
	644	PUR	22	Yellow	.210"	AWM 20233